

395 CC



Everglades

TABLE OF CONTENTS

TABLE OF CONTENTS	3
SAFETY INFORMATION	7
BOAT INFORMATION	9
SPECIFICATIONS	10
CERTIFICATIONS	11
INTRODUCTION & IMPORTANT INFORMATION	13
OWNER/OPERATOR INFORMATION	15

Chapter 1:

SAFETY EQUIPMENT

1.1 General	17
1.2 Engine Alarms	17
1.3 Neutral Safety Switch	17
1.4 Engine Stop Switch	17
1.5 Required Safety Equipment	18
1.6 Bilge & Fuel Fires	19
1.7 Carbon Monoxide Monitoring System	20
1.8 First Aid	21
1.9 Additional Safety Equipment	22
1.10 Caution & Warning Labels	23

Chapter 2:

OPERATION

2.1 General	25
2.2 Rules of the Road	25
2.3 Pre-Cruise Check	28
2.4 Operating Your Boat	29
2.5 Docking, Anchoring & Mooring	30
2.6 Controls, Steering or Propulsion System Failure	33
2.7 Collision	33
2.8 Grounding, Towing & Rendering Assistance	33
2.9 Flooding or Capsizing	34
2.10 Fishing	34
2.11 Tower Operation (Optional)	34
2.12 Man Overboard	35
2.13 Trash Disposal	35
2.14 Yacht Certification Plate	36
2.15 Transporting Your Boat	36

Chapter 3:

PROPULSION SYSTEM

3.1 General	37
3.2 Drive System Corrosion	37
3.3 Engine Lubrication	38
3.4 Engine Cooling System	38
3.5 Propellers	38
3.6 Performance Issues & Propellers	38
3.7 Hull Ventilation Thru-Hulls	40
3.8 Engine Instrumentation	41

TABLE OF CONTENTS

Chapter 4:

HELM CONTROL SYSTEMS

4.1 General	44
4.2 Engine Throttle & Shift Controls	44
4.3 Neutral Safety Switch	46
4.4 Engine Power Tilt & Trim	46
4.5 Engine Stop Switch	48
4.6 Steering System	49
4.7 Joystick Controls	50
4.8 Zipwake Trim Tabs.....	51
4.9 Control Systems Maintenance	52

Chapter 5:

FUEL SYSTEM

5.1 General	53
5.2 Outboard Engine Fuel System	54
5.3 Diesel Generator Fuel System	55
5.4 Fueling Instructions.....	56
5.5 Fuel System Maintenance.....	57

Chapter 6:

ELECTRICAL SYSTEM

6.1 General	59
6.2 DC System Overview	59
6.3 Batteries & Battery Switches.....	60
6.4 Remote Battery Switch Panel	62
6.5 Ignition Switch Panels.....	63
6.6 12 Volt Helm Accessory Switch Panels.....	65
6.7 Digital Touch Control System	74
6.8 DC System Circuit Protection	77
6.9 DC Power Management	81
6.10 120 Volt AC Electrical System	82
6.11 Cabin 120 volt AC Circuit Breaker Panel.....	85
6.12 Generator.....	89
6.13 Bonding System & Galvanic Isolator	91
6.14 Electrical System Maintenance	91
6.15 AC Line Load Estimator	93

Chapter 7:

Fresh Water System

7.1 General	95
7.2 Fresh Water System Operation.....	95
7.3 Water Heater	97
7.4 Fresh Water System Maintenance.....	97

TABLE OF CONTENTS

Chapter 8:

RAW WATER SYSTEM

8.1 General	99
8.2 Raw Water System Operation	99
8.3 Livewells.....	100
8.4 Livewell Y-Valves.....	101
8.5 Air Conditioning Pump	101
8.6 SeaKeeper Cooling Pump	102
8.7 Generator Raw Water Supply	102
8.8 Raw Water System Maintenance.....	103

Chapter 9:

DRAINAGE SYSTEMS

9.1 General	105
9.2 Cockpit & Deck Drainage	105
9.3 Hardtop & Tower Drains	106
9.4 Bilge Drainage.....	107
9.5 Cabin Drainage.....	108
9.6 Drainage System Maintenance	109

Chapter 10:

VENTILATION SYSTEM

10.1 Cabin Ventilation	111
10.2 Windshield/Helm Compartment Ventilation	112
10.3 Carbon Monoxide & Proper Ventilation	112
10.4 Bilge & Aft systems compartment Ventilation	114
10.5 Maintenance	114

Chapter 11:

EXTERIOR EQUIPMENT

11.1 Deck	117
11.2 Rope Locker & Windlass	117
11.3 Hull	120
11.4 Cockpit Features	122
11.5 Mezzanine.....	127
11.6 Bow Area Seats & Compartments	131
11.7 Helm & Console Cabin.....	134
11.8 Hardtop	137
11.9 Upper Station (Optional)	138
11.10 Aftermarket Hardtop or Tower	141

Chapter 12:

INTERIOR EQUIPMENT

12.1 Head Compartment	143
12.2 Marine Head System.....	145
12.3 Main Cabin	147
12.4 Air Conditioner	151
12.5 Cabin Woodwork	152

TABLE OF CONTENTS

Chapter 13:

ROUTINE MAINTENANCE

13.1 Exterior Hull & Deck	153
13.2 Upholstery, Canvas & Enclosures	156
13.3 Interior	158
13.4 Windshield Hydraulic System	159
13.5 Engines & Fuel	159
13.6 Bilge, Pumps & Components	159
13.7 Generator	160
13.8 Drainage System.....	160

Chapter 14:

SEASONAL MAINTENANCE

14.1 Storage & Lay-up	161
14.2 Winterizing.....	163
14.3 Recommissioning	166

Appendix A:

GLOSSARY OF TERMS	167
-------------------------	-----

Appendix B:

MAINTENANCE LOG	171
-----------------------	-----

Appendix C:

BOATING ACCIDENT REPORT	175
-------------------------------	-----

Appendix D:

FLOAT PLAN.....	179
-----------------	-----

Appendix E:

TROUBLESHOOTING GUIDE	181
-----------------------------	-----

Appendix F:

Schematics.....	187
Bilge Layout.....	187
Graving Plan	188

SAFETY INFORMATION

Your Everglades owner's manual has been written to include a number of safety instructions to assure the safe operation and maintenance of your boat. These instructions are in the form of **DANGER**, **WARNING** and **CAUTION** statements. The following definitions apply:

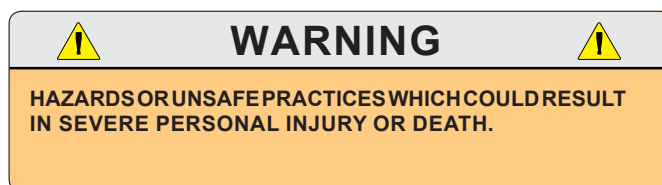

All instructions given in this book are as seen from the stern looking toward the bow, with starboard being to your right and port to your left. A glossary of boating terms is included.

IMPORTANT NOTE: Your boat uses an internal combustion engine and flammable fuel. Every precaution has been taken by Everglades to reduce the risks associated with possible injury and damage from fire or explosion, but your own precaution and good maintenance procedures are necessary in order to enjoy safe operation of your boat.

SAFETY INFORMATION

State of California Safety Requirements



WARNING



PROPOSITION 65

OPERATING, SERVICING AND MAINTAINING A RECREATIONAL MARINE VESSEL CAN EXPOSE YOU TO CHEMICALS INCLUDING ENGINE EXHAUST, CARBON MONOXIDE, PHTHALATES, AND LEAD, WHICH ARE KNOWN TO THE STATE OF CALIFORNIA TO CAUSE CANCER AND BIRTH DEFECTS OR OTHER REPRODUCTIVE HARM. TO MINIMIZE EXPOSURE, AVOID BREATHING EXHAUST, SERVICE YOUR VESSEL IN A WELL-VENTILATED AREA AND WEAR GLOVES OR WASH YOUR HANDS FREQUENTLY WHEN SERVICING THIS VESSEL. FOR MORE INFORMATION GO TO WWW.P65WARNING.CA.GOV/MARINE.

California Health & Safety Code §§ 25249.5-.13

State of California Emission Requirements

Your boat may be equipped with an engine that meets the special requirements outlined by the California Air Resources Board (CARB). If so, the engine is designed to meet strict requirements and the boat will have a special tag and one of the following labels affixed to it.

The tag and the label are required by CARB. The label has 1, 2, 3 or 4 stars and must be affixed to your boat if it is to be operated in the state of California and/or bordering waters. For more information visit: <http://www.arb.ca.gov>.



BOAT INFORMATION

Please fill out the following information section and leave it in your Everglades owner's manual. This information will be important for you, your dealer and/or Everglades service personnel to know, if you may need to call them for technical assistance or service.

BOAT	
MODEL:	HULL ID #:
PURCHASE DATE:	DELIVERY DATE:
IGNITION KEYS #:	REGISTRATION #:
DOOR KEYS #:	OTHER KEYS #:
ENGINES	
MAKE:	MODEL:
PORT SERIAL #:	STARBOARD SERIAL #:
CTR SERIAL #:	
GENERATOR	
MAKE:	MODEL:
SERIAL #:	KILOWATTS:
PROPELLERS	
MAKE:	BLADES:
RH DIAMETER/PITCH:	LH DIAMETER/PITCH:
AIR CONDITIONERS	
MAKE:	MODEL:
SERIAL #:	BTU OUTPUT:
SERIAL #:	BTU OUTPUT:
ADDITIONAL EQUIPMENT	
DEALER	EVERGLADES
NAME:	REPRESENTATIVE:
DEALER/PHONE:	EVERGLADES PHONE:
SALESMAN:	ADDRESS:
SERVICE MANAGER:	
ADDRESS:	
DEALER E-MAIL:	EVERGLADES E-MAIL:

All information, illustrations and specifications contained in this manual are based on the latest product information available at the time of publication. Everglades Boats reserves the right to make changes at anytime, without notice, in colors, materials, equipment, specifications and models.

SPECIFICATIONS

395 CC Specifications

HULL LENGTH OVERALL WITHOUT ENGINES	39' (11.89 m)
HULL LENGTH OVERALL WITH ENGINES	42' 2" (12.85 m)
BEAM	12' 0" (3.65 m)
WEIGHT DRY - NO ENGINES	16,650 lbs (7,552.31 k)
WEIGHT DRY STANDARD	19,650 lbs (8,913.09 k)
WEIGHT FULLY LOADED	24,625 lbs (11,169.71 k)
WEIGHT FULLY LOADED WITH SEAKEEPER	25,520 lbs (11,575.68 k)
DEAD RISE @ TRANSOM	25°
DEAD RISE - AVERAGE	41°
DRAFT - HULL ONLY	32" (.81 m)
DRAFT WITH ENGINES DOWN	46" (1.17 m)
TRANSOM HEIGHT	30"/35"/30" (.76 m / .89 m / .76 m)
BRIDGE CLEARANCE WITH HARDTOP	9' 9" (2.97 m)
BRIDGE CLEARANCE WITH UPPER STATION	14' 8" (4.47 m)
BRIDGE CLEARANCE - UPPER STATION UPRIGHT	17' 6" (5.33 m)
BRIDGE CLEARANCE - UPPER STATION FOLDED	13' 8" (4.17 m)
SHIPPING HEIGHT WITH HARDTOP	12' 5" (3.78 m)
SHIPPING HEIGHT WITH UPPER STATION	13' 3" (4.02 m)
GASOLINE FUEL CAPACITY	600 gal (2,271 l)
DIESEL FUEL CAPACITY	17 gal (64.4 l)
WATER TANK CAPACITY	50 gal (189.3 l)
WASTE TANK CAPACITY	15 gal (56.8 l)
AFT FISH BOX	75 gal (284.9 l)
FORWARD FISH BOX	112 gal (424 l)
LIVWELL CAPACITY (2)	40 gal each (151.4 l each)
WATER HEATER	6 gal (22.7 l)
MAXIMUM HORSEPOWER	1,275 hp (950.76 kw)
SLING LOCATIONS - AFT (inches from transom)	74" (1.88 m)
SLING LOCATIONS - FORWARD (inches from transom)	266" (6.75 m)

Notice:

Dry weight is the average weight of the base boat without engines, fuel, water, waste or gear.

Specifications and weights are approximate and may differ from boat to boat.

CERTIFICATIONS

395 CC Export Documentation

(For Export Only)

To be in compliance with European directives for recreational boats as published by the International Organization for Standardization (ISO) in effect at the time this boat was manufactured, we are providing the following information.

Manufacturer:

Name Everglades Boats
544 Air Park Road
Edgewater, FL Zip Code: 32132

Identification Numbers:

Hull Identification Number _____
Engine Serial Number _____

Intended Design Category:

- Ocean (Cat A) Inshore (Cat C)
 Offshore (Cat B) Sheltered Waters (Cat D)

Weight and Maximum Capacities:

Unladen Weight - Kilograms (Pounds) 8,913.09 (19,650)
Maximum Load - Weight- Kilograms (Pounds) 11,169.71 (10,360)
Number of People 15
Maximum Rated Engine Horsepower - Kilowatts (Horsepower) 950.76 kw (1,275)

Certifications:

Certifications & Components Covered See Declaration of Conformity

NOTES

INTRODUCTION & IMPORTANT INFORMATION

All instructions given in this book are as seen from the stern looking toward the bow with starboard being to your right and port to your left. The information and precautions listed in this manual are not all inclusive. It may be general in nature in some cases and detailed in others and is designed to provide you with a basic understanding of your Everglades boat and some of the responsibilities that go along with owning/operating your boat.

The suppliers of some of the major components such as the engines, pumps and appliances, provide their own owner's manuals which have been included with your boat. You should read the information in this manual and the manuals of other suppliers completely and have a thorough understanding of all component systems and their proper operation before operating your boat.

REMEMBER - IT IS YOUR RESPONSIBILITY TO ENSURE THAT YOUR BOAT IS SAFE FOR YOU AND YOUR PASSENGERS. ALWAYS EXERCISE GOOD COMMON SENSE WHEN INSTALLING EQUIPMENT AND OPERATING THE BOAT.

Warranty and Warranty Registration Cards

The Everglades Limited Warranty Statement is included with your boat. It has been written to be clearly stated and easily understood. If you have any questions after reading the warranty, please contact the Everglades Boats Customer Service Department.

Everglades, engine manufacturers and the suppliers of major components maintain their own manufacturer's warranty and service facilities. It is important that you properly complete the warranty registration cards included with your boat and engine and mail them back to the manufacturer to register your ownership. This should be done within 15 days of the date of purchase and before the boat is put into service. A form for recording this information for your records is provided at the beginning of this manual. This information will be important for you and service personnel to know, if and when you may need service or technical information.

The boat warranty registration requires the Hull Identification Number "HIN" which is located on the starboard side of the transom, just below the rubrail. The engine warranty registration requires the engine serial numbers. Please refer to the engine owner's manual for the location of the serial numbers.



Hull ID # On Starboard Side of Transom

IMPORTANT:

The terms and conditions of the Everglades Boats Limited Warranty are outlined in the warranty statement included in this manual. The manufacturer will automatically honor the warranty to the original purchaser for 15 days from the date of purchase. However, during that 15 day period, owners must comply with the steps outlined in the warranty statement to validate their warranty.

All boat manufacturers are required by the Federal Boat Safety Act of 1971 to notify first time owners in the event any defect is discovered "which creates a substantial risk of personal injury to the public." It is essential that we have your warranty registration card complete with your name and mailing address in our files so that we can comply with the law if it should become necessary.

Your Everglades Boats Dealer will assist you in filling in the hull number and other data required on your Registration Card. Check to see that your card is complete and signed. Detach and mail. Your Warranty Registration Card will be added to our permanent files.

Transferring the Limited Structural Warranty

For a transfer fee, Everglades Boats will offer to extend a Transferable Limited Structural Hull Warranty to subsequent owners of Everglades Boats. Please refer to the Everglades Limited Warranty Statement for the terms and conditions of the Transferable Limited Structural Hull Warranty and the procedure to transfer the warranty.

Product Changes

Everglades is committed to the continuous improvement of our boats. As a result, some of the equipment described in this manual or pictured in the catalog may change or no longer be available. All information, illustrations and specifications contained in this manual are based on the latest product information available at the time of publication. Everglades Boats reserves the right to make changes at anytime, without notice, in colors, materials, equipment, specifications and models. If you have questions about the equipment on your Everglades, please contact the Everglades Boats Customer Service Department.

Service

All warranty repairs must be performed by an authorized Everglades Dealer. Should a problem develop that is related to faulty workmanship or materials, as stated in the Limited Warranty, you should contact your Everglades dealer to arrange for the necessary repair. If you are not near your dealer or another authorized Everglades dealer or the dealer fails to remedy the cause of the problem, then contact Everglades within 15 days.

Everglades will not reimburse boat owners for warranty repairs performed without prior authorization provided in writing.

It is the boat owner's responsibility to deliver the boat to the dealer for warranty service.

OWNER/OPERATOR INFORMATION

Registration and Numbering

Federal law requires that all undocumented vessels equipped with propulsion machinery be registered in the state of principal use. A certificate of number will be issued upon registering the boat. These numbers must be displayed on your boat. The owner/operator of a boat must carry a valid certificate of number whenever the boat is in use. When moved to a new state of principal use, the certificate is valid for 60 days.

In order to be valid, the numbers must be installed to the proper specifications. Check with your dealer or state boating authority for numbering requirements. The Coast Guard issues the certificate of number in Alaska; all others are issued by the state.

Insurance

In most states the boat owner is legally responsible for damages or injuries he or someone else operating the boat causes. Responsible boaters carry adequate liability and property damage insurance for their boat. You should also protect the boat against physical damage and theft. Some states have laws requiring minimum insurance coverage. Contact your dealer or state boating authority for information on the insurance requirements in your boating area.

Reporting Boating accidents

All boating accidents must be reported by the operator or owner of the boat to the proper marine law enforcement authority for the state in which the accident occurred. Immediate notification is required if a person dies or disappears as a result of a recreational boating accident.

If a person dies or there are injuries requiring more than first aid, a formal report must be filed within 48 hours.

A formal report must be made within 10 days for accidents involving more than \$500.00 damage or the complete loss of a boat.

A Boating Accident Report form is located near the back of this manual to assist you in reporting

an accident. If you need additional information regarding accident reporting, please visit the U.S. Coast Guard Boating Safety web site, www.uscgboating.org,

Education

If you are not an experienced boater, we recommend that the boat operator and other people that normally accompany the operator, enroll in a boating safety course. Organizations such as the U.S. Power Striplerons, United States Coast Guard Auxiliary, State Boating Authorities and the American Red Cross offer excellent boating educational programs. These courses are worthwhile even for experienced boaters to sharpen your skills or bring you up to date on current rules and regulations. They can also help in providing local navigational information when moving to a new boating area. Contact your dealer, State Boating Authority or visit the U.S. Coast Guard Boating Safety web site, www.uscgboating.org, for information on boat safety courses.

Required Equipment

U.S. Coast Guard regulations require certain equipment on each boat. The Coast Guard also sets minimum safety standards for vessels and associated equipment. To meet these standards some of the equipment must be Coast Guard approved. "Coast Guard Approved Equipment" has been determined to be in compliance with USCG specifications and regulations relating to performance, construction or materials. The equipment requirements vary according to the length, type of boat and the propulsion system. Some of the Coast Guard equipment is described in the Safety Equipment chapter of this manual. For a more detailed description, obtain "Federal Requirements And Safety Tips For Recreational Boats" by visiting the U.S. Coast Guard Boating Safety web site, www.uscgboating.org.

Some state and local agencies impose similar equipment requirements on waters that do not fall under Coast Guard jurisdiction. These agencies may also require additional equipment that is not required by the Coast Guard. Your dealer or local boating authority can provide you with additional information for the equipment requirements for your boating area.

NOTES

Safety Equipment

Notice:

You should carry an extra stop switch lanyard and instruct at least one other crew member on the operation of the stop switch and location of the extra lanyard.

1.5 Required Safety Equipment

Besides the equipment installed on your boat by Everglades, certain other equipment is required by the U.S. Coast Guard to help ensure passenger safety. Items like a sea anchor, working anchor, extra dock lines, flare pistol, life vests, a line permanently secured to your ring buoy, etc., could at some time save your passengers' lives or save your boat from damage. Refer to the "Federal Requirements And Safety Tips For Recreational Boats" pamphlet for a more detailed description of required equipment. You also can visit the U.S. Coast Guard Boating Safety web site, www.uscgboating.org, for information on boat safety courses and brochures listing the Federal equipment requirements. Also, check your local and state regulations.

The Coast Guard Auxiliary offers a "Courtesy Examination." This inspection will help ensure that your boat is equipped with all of the necessary safety equipment. The following is a list of the accessory equipment required on your boat by the U.S. Coast Guard:

Personal Flotation Devices (PFDs)

PFDs must be Coast Guard approved, in good and serviceable condition and of appropriate size for the intended user. Wearable PFDs must be readily accessible, meaning you must be able to put them on in a reasonable amount of time in an emergency. Though not required, the Coast Guard emphasizes that PFDs should be worn at all times when the vessel is underway. Throwable devices must be immediately available for use. All Everglades boats must be equipped with at least one Type I, II or III PFD for each person on board, plus one throwable device (Type IV).

Notice:

Many state laws now require that children 13 years old and under must wear a PFD at all times.

Anyone being towed on skis, wakeboards and other water sports equipment is considered a passenger on the boat and must wear a Coast Guard approved life jacket at all times.



Visual Distress Signals

All boats used on coastal waters, the Great Lakes, territorial seas and those waters connected directly to them, must be equipped with Coast Guard approved visual distress signals. These signals are either Pyrotechnic or Non-Pyrotechnic devices.

Pyrotechnic Visual Distress Signals:

Pyrotechnic visual distress signals must be Coast Guard approved, in serviceable condition and readily accessible. They are marked with a date showing the service life, which must not have expired. A minimum of three are required. Some pyrotechnic signals meet both day and night use requirements. They should be stored in a cool, dry location. They include:

- Pyrotechnic red flares, hand held or aerial.
- Pyrotechnic orange smoke, hand-held or floating.
- Launchers for aerial red meteors or parachute flares.

	WARNING	
<p>PYROTECHNICS ARE UNIVERSALLY RECOGNIZED AS EXCELLENT DISTRESS SIGNALS. HOWEVER, THERE IS POTENTIAL FOR INJURY AND PROPERTY DAMAGE IF NOT PROPERLY HANDLED. THESE DEVICES PRODUCE A VERY HOT FLAME AND THE RESIDUE CAN CAUSE BURNS AND IGNITE FLAMMABLE MATERIAL. PISTOL LAUNCHED AND HAND-HELD PARACHUTE FLARES AND METEORS HAVE MANY CHARACTERISTICS OF A FIREARM AND MUST BE HANDLED WITH CAUTION. IN SOME STATES THEY ARE CONSIDERED A FIREARM AND PROHIBITED FROM USE. ALWAYS BE EXTREMELY CAREFUL AND FOLLOW THE MANUFACTURER'S INSTRUCTIONS EXACTLY WHEN USING PYROTECHNIC DISTRESS SIGNALS.</p>		

Non-Pyrotechnic Devices

Non-Pyrotechnic visual distress signals must be in serviceable condition, readily accessible and certified by the manufacturer as complying with U.S. Coast Guard requirements. They include:

- Orange Distress Flag (Day use only)

The distress flag is a day signal only. It must be at least 3 x 3 feet with a black square and ball on an orange background. It is most distinctive when attached and waved from a paddle or boat hook.

Safety Equipment

- Electric Distress Light (Night use only)

The electric distress light is accepted for night use only and must automatically flash the international SOS distress signal. Under "Inland Navigation Rules," a high intensity white light flashing at regular intervals from 50-70 times per minute is considered a distress signal.

Sound Signaling Devices

The navigation rules require sound signals to be made under certain circumstances. Recreational vessels also are required to sound fog signals during periods of reduced visibility. Therefore, you must have some means of making an efficient sound signal.

Navigation Lights

Recreational boats are required to display navigation lights between sunset and sunrise and other periods of reduced visibility (fog, rain, haze, etc.) Navigation lights are intended to keep other vessels informed of your presence and course. Your boat is equipped with navigation lights required by the U.S. Coast Guard at the time of manufacture. It is up to you to make sure they are operational and turned on when required.

Fire Extinguishers

Your boat is required to have two Marine Type USCG approved fire extinguishers. Coast Guard approved fire extinguishers are hand-portable, either B-I or B-II classification and have a specific marine type mounting bracket. It is recommended that the extinguishers be mounted in a readily accessible position.





Fire extinguishers require regular inspections to ensure that:

- Seals & tamper indicators are not broken or missing.
- Pressure gauges or indicators read in the operable range.
- There is no obvious physical damage, corrosion, leakage or clogged nozzles.



Refer to the "Federal Requirements And Safety Tips For Recreational Boats" pamphlet or visit the U.S. Coast Guard Boating Safety web site, www.uscgboating.org, for information on the type and size fire extinguisher required for your boat.

Please refer to the information provided by the fire extinguisher manufacturer for instructions on the proper maintenance and use of your fire extinguisher.

	CAUTION	
<p>INFORMATION FOR HALON, AGENT FE-241 AND AGENT FM 200 FIRE EXTINGUISHERS IS PROVIDED BY THE MANUFACTURER. IT IS ESSENTIAL THAT YOU READ THE INFORMATION CAREFULLY AND COMPLETELY UNDERSTAND THE SYSTEM, IN THEORY AND OPERATION, BEFORE USING YOUR BOAT.</p>		



1.6 Bilge & Fuel Fires

Fuel compartment and bilge fires are very dangerous because of the presence of gasoline in the various components of the fuel system and the possibility for explosion. You must make the decision to fight the fire or abandon the boat. If the fire cannot be extinguished quickly or it is too intense to fight, abandoning the boat may be your only option. If you find yourself in this situation, make sure all passengers have a life preserver on and go over the side and swim well upwind of the boat. This will keep you and your passengers well clear of any burning fuel that could be released and spread on the water as the boat burns or in the event of an explosion. When clear of the danger, check about and account for all those who were aboard with you. Give whatever assistance you can to anyone in need or in the water without a buoyant device. Keep everyone together in a group for morale and to aid rescue operations.

	WARNING	
<p>GASOLINE CAN EXPLODE. IN THE EVENT OF A FUEL COMPARTMENT OR BILGE FIRE, YOU MUST MAKE THE DIFFICULT DECISION TO FIGHT THE FIRE OR ABANDON THE BOAT. YOU MUST CONSIDER YOUR SAFETY, THE SAFETY OF YOUR PASSENGERS, THE INTENSITY OF THE FIRE AND THE POSSIBILITY OF AN EXPLOSION IN YOUR DECISION.</p>		

Safety Equipment

1.7 Carbon Monoxide Monitoring System

 **DANGER** 

CARBON MONOXIDE IS COLORLESS, ODORLESS AND DANGEROUS. ALL ENGINES, GENERATORS AND FUEL BURNING APPLIANCES EXHAUST CARBON MONOXIDE (CO). DIRECT AND PROLONGED EXPOSURE TO CO WILL CAUSE BRAIN DAMAGE OR DEATH. SIGNS OF EXPOSURE TO CO INCLUDE NAUSEA, DIZZINESS AND DROWSINESS.

The carbon monoxide (CO) detector is installed in the cabin as standard equipment and warns the occupants of dangerous accumulations of carbon monoxide gas. If excess carbon monoxide fumes are detected, the detector will sound an alarm indicating the presence of the toxic gas.

Should a very high level of carbon monoxide exist, the alarm will sound in a few minutes. However, if small quantities of CO are present or high levels are short-lived, the alarm will accumulate the information and determine when an alarm level has been reached.

The carbon monoxide detector is automatically activated whenever the House battery is connected. The power light on the carbon monoxide detector should be lit to indicate that the carbon monoxide detector is activated.

Always make sure the power light on the carbon monoxide detector is lit whenever the cabin is occupied.

A by-product of combustion, carbon monoxide (CO) is invisible, tasteless, odorless and is produced by all engines, heating and cooking appliances. The most common sources of CO on boats are the engines, auxiliary generators and propane or butane stoves. These produce large amounts of CO and should never be operated while sleeping.

A slight buildup of carbon monoxide over several hours causes headache, nausea and other symptoms that are similar to food poisoning, motion sickness or flu. High concentrations can be fatal within minutes. Many cases of carbon monoxide poisoning indicate that while victims are aware they are not well, they become so disoriented they are unable to save themselves by either exiting the area or calling for help. Also, young children, elderly persons and pets may be the first affected.



Cabin Carbon Monoxide Detector

Drug or alcohol use increases the effect of CO exposure. Individuals with cardiac or respiratory conditions are very susceptible to the dangers of carbon monoxide. CO poisoning is especially dangerous during sleep when victims are unaware of any side effects. The following are symptoms which may signal exposure to CO: (1) Headache (2) Tightness of chest or hyperventilation (3) Flushed face (4) Nausea (5) Drowsiness (6) Fatigue or Weakness (7) Inattention or confusion (8) Lack of normal coordination.

Persons who have been exposed to carbon monoxide should be moved into fresh air immediately. Have the victim breathe deeply and seek immediate medical attention. To learn more about CO poisoning, contact your local health authorities. Low levels of carbon monoxide over an extended period of time can be just as lethal as high doses over a short period. Therefore, low levels of carbon monoxide can cause the alarm to sound before the occupants of the boat notice any symptoms of carbon monoxide poisoning. CO detectors are very reliable and rarely sound false alarms. If the alarm sounds, always assume the hazard is real and move persons who have been exposed to carbon monoxide into fresh air immediately. Never disable the CO detector because you think the alarm may be false. Always contact the detector manufacturer or your local fire department for assistance in finding and correcting the situation.



Typical First Aid Kit

Remember, carbon monoxide detectors do not guarantee that CO poisoning will not occur. Do not use the CO detector as a replacement for ordinary precautions or periodic inspections of equipment. Never rely on alarm systems to save your life, common sense is still prudent and necessary.

You should read the owner's manual supplied by the CO detector manufacturer and included with this manual for operation instructions and additional information regarding the hazards of carbon monoxide gas. Refer to the Ventilation System chapter for information on ventilating your boat properly while underway and other precautions while at anchor or in a slip. This is especially essential if your boat is equipped with the generator.

Many manufacturers of carbon monoxide detectors offer a testing and recertification program. We recommend that you contact the manufacturer of your carbon monoxide detector and have it tested and recertified periodically.

1.8 First Aid

It is the operator's responsibility to be familiar with the proper first-aid procedures and be able to care for minor injuries or illnesses of your passengers. In an emergency, you could be far from professional medical assistance. We strongly recommend that you be prepared by receiving training in basic first aid and CPR. This can be done through classes given by the Red Cross or your local hospital.

Your boat should also be equipped with at least a simple marine first-aid kit and a first-aid manual. The marine first-aid kit should be designed for the marine environment and be well supplied. It should be accessible and each person on board should be aware of its location. As supplies are used, replace them promptly. Some common drugs and antiseptics may lose their strength or become unstable as they age. Ask a medical professional about the supplies you should carry and the safe shelf life of prescription drugs or other medical supplies that may be in your first-aid kit. Replace questionably old supplies whether they have been used or not.

Safety Equipment

In many emergency situations, the Coast Guard can provide assistance in obtaining medical advice for treatment of serious injuries or illness. If you are within VHF range of a Coast Guard Station, make the initial contact on channel 16 and follow their instructions.

1.9 Additional Safety Equipment

Besides meeting the legal requirements, prudent boaters carry additional safety equipment. This is particularly important if you operate your boat offshore. You should consider the following items, depending on how you use your boat.

Satellite EPIRBs

EPIRBs (Emergency Position Indicating Radio Beacon) operate as part of a worldwide distress system. When activated, EPIRBs will send distress code homing beacons that allow Coast Guard aircraft to identify and find them quickly. The satellites that receive and relay EPIRB signals are operated by the National Oceanic and Atmospheric Administration (NOAA) in the United States. The EPIRB should be mounted and registered according to the instructions provided with the beacon, so that the beacon's unique distress code can be used to quickly identify the boat and owner.

Marine Radio

A marine radio is the most effective method of receiving information and requesting assistance. VHF marine radios are used near shore and single sideband radios are used for long range communication.

There are specific frequencies to use in an emergency. The VHF emergency channel is 16 in the United States. You should read the owners manual for your radio and know how to use it in an emergency or for normal operation. If you hear a distress call you should assist or monitor the situation until help is provided.

Additional Equipment to Consider:

Cell Phone	Spare Anchor
Fenders	Heaving Line
Mirror	First Aid Kit
Tool Kit	Flashlight & Batteries
Anchor	Search light
Boat Hook	Sunburn Lotion
Mooring Lines	Ring Buoy or Boat Cushion
Binoculars	Whistle or Horn
Extra Clothing	Portable Radio
Chart and Compass	Marine Hardware
Food & Water	Spare Keys
Sunglasses	Spare Parts
Spare Propellers	Spare Propeller Hub Kits

Safety Equipment

1.10 Caution & Warning Labels

The caution and warning labels shown are examples of the labels that could be on your boat. The actual labels and their location could vary on your boat.

Caution and warning labels must remain legible for the safety of you and your passengers. If a label becomes missing or damaged it must be replaced. Immediately contact your dealer or Everglades Customer Service for a replacement.

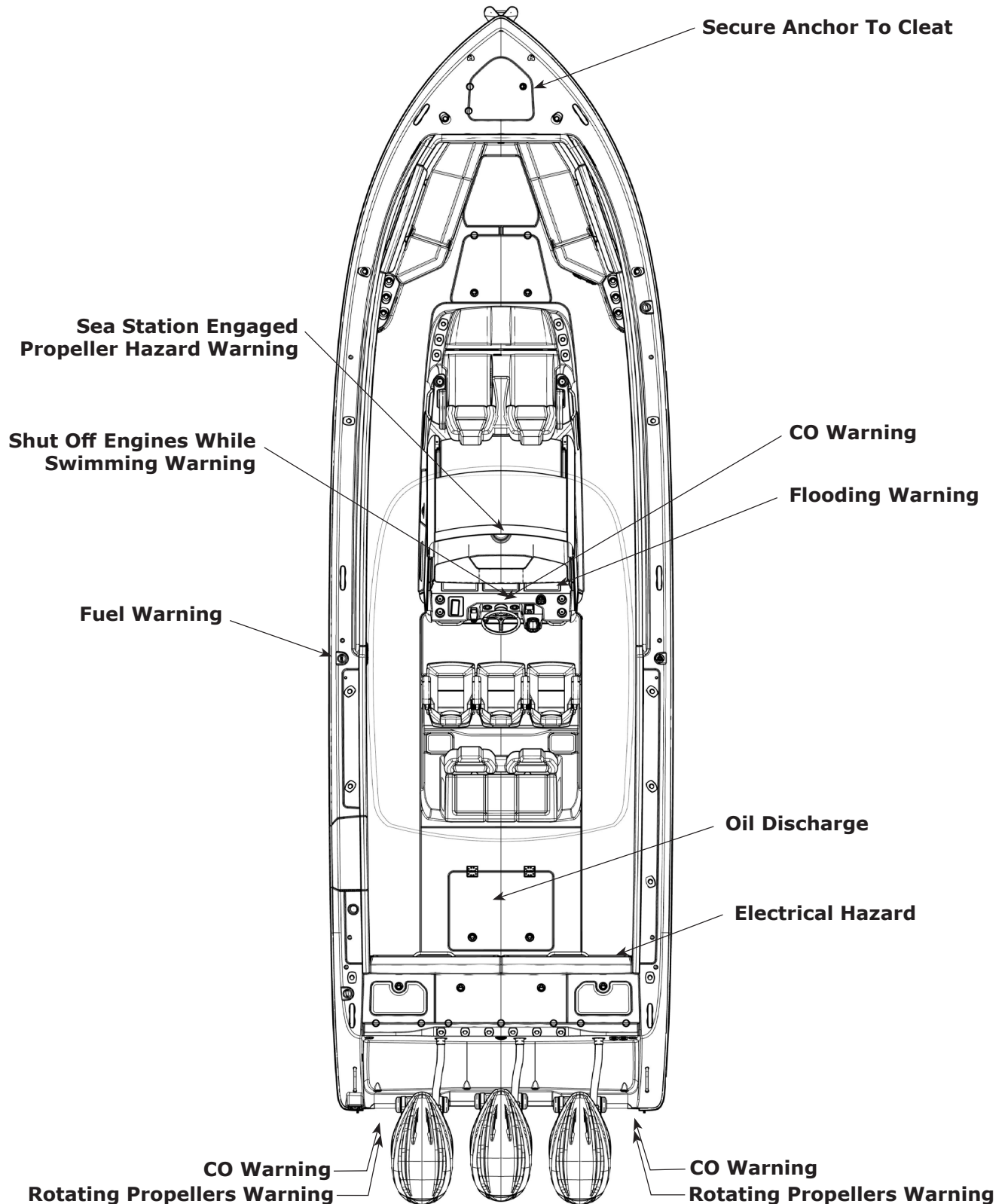

NOTES

OPERATION

2.1 General

Before you start the engines on your Everglades, you should have become familiar with the various component systems and their operation and have performed a "Pre-Cruise System Check." A thorough understanding of the component systems and their operation is essential to the proper operation of the boat. This manual and the associated manufacturers' information is provided to enhance your knowledge of your boat. Please read them carefully.

Your boat must have the necessary safety equipment on board and be in compliance with the U.S. Coast Guard, local and state safety regulations. There should be one Personal Flotation Device (PFD) for each person. Non-swimmers and small children should wear PFDs at all times. You should know and understand the "Rules of the Road" and have had an experienced operator brief you on the general operation of your new boat. At least one other person should be instructed on the proper operation of the boat in case the operator is suddenly incapacitated.

The operator is responsible for his safety and the safety of his passengers. When boarding or loading the boat, always step onto the boat, never jump. All passengers should be properly seated whenever the boat is operated above idle speed. Your passengers should not be allowed to sit on the seat backs, gunnels, bows or transoms whenever the boat is underway. The passengers should also be seated to properly balance the load and must not obstruct the operator's view, particularly to the front.

Overloading and improper distribution of weight can cause the boat to become unstable and are significant causes of accidents. Know the weight capacity and horsepower rating of your boat. Do not overload or overpower your boat.

You should be aware of your limitations and the limitations of your boat in different situations or sea conditions. No boat is indestructible, no matter how well it is constructed. Any boat can be severely damaged if it is operated in a manner that exceeds its design limitations. If the ride is hard on you and your passengers, it is hard on

the boat as well. Always modify the boat speed in accordance with the sea conditions, boat traffic and weather conditions.

Remember, it is the operator's responsibility to use good common sense and sound judgement in loading and operating the boat.

2.2 Rules of the Road

As in driving an automobile, there are a few rules you must know for safe boating operation. The following information describes the basic navigation rules and action to be taken by vessels in crossing, meeting or overtaking situations while operating in inland waters. These are basic examples and not intended to teach all the rules of navigation. For further information consult the "Navigation Rules" or contact the Coast Guard, Coast Guard Auxiliary, Department of Natural Resources or your local boat club. These organizations sponsor courses in boat handling, including rules of the road. We strongly recommend such courses. Books or videos on this subject also are available from your local library.

Notice:

Sailboats not under power, paddle boats, vessels unable to maneuver, vessels engaged in commercial fishing and other vessels without power have the right-of-way over motor powered boats. You must stay clear or pass to the stern of these vessels. Sailboats under power are considered motor boats.

Crossing Situations

When two motor boats are crossing, the boat on the right has the right-of-way. The boat with the right-of-way should maintain its course and speed. The other vessel should slow down and permit it to pass. The boats should sound the appropriate signals.

Meeting Head-On or Nearly-So Situations

When two motor boats are approaching each other head-on or nearly head-on, neither boat has the right-of-way. Both boats should reduce their speed and turn to the right so as to pass port side to port side, providing enough clearance for safe passage. The boats should sound the appropriate signals.

Operation

Overtaking Situations

When one motor boat is overtaking another motor boat, the boat that is being passed has the right-of-way. The overtaking boat must make the adjustments necessary to provide clearance for a safe passage of the other vessel. The boats should sound the appropriate signals.

The General Prudential Rule

In obeying the Rules of the Road, due regard must be given to all dangers of navigation and collision and to any special circumstances, including the limitations of the vessels, which may justify a departure from the rules that is necessary to avoid immediate danger or a collision.

Night Operation

Recreational boats are required to display navigation lights between sunset and sunrise and other periods of reduced visibility such as fog, rain, haze, etc. When operating your boat at night you should:

- Make sure your navigation lights are on and working properly. Navigation lights warn others of your position and course and the position and course of other vessels.
- All navigation rules apply. If the bow light of another vessel shows red, you should give way to that vessel, if it shows green, you have the right-of-way.
- Slow down and never operate at high speeds when operating at night, stay clear of all boats and use good common sense. Always be ready to slow down or steer clear of other vessels, even if you have the right-of-way.
- Avoid bright lights that can destroy night vision, making it difficult to see navigation lights and the lights of other boats. You and your passengers should keep a sharp lookout for hazards, other boats and navigational aids.

Navigation Aids

Aids to navigation are placed along coasts and navigable waters as guides to mark safe water and to assist mariners in determining their position in relation to land and hidden dangers. Each aid to navigation is used to provide specific information. You should be familiar with these and any other markers used in your boating area.

Notice:

Storms and wave action can cause buoys to move. You should not rely on buoys alone to determine your position.

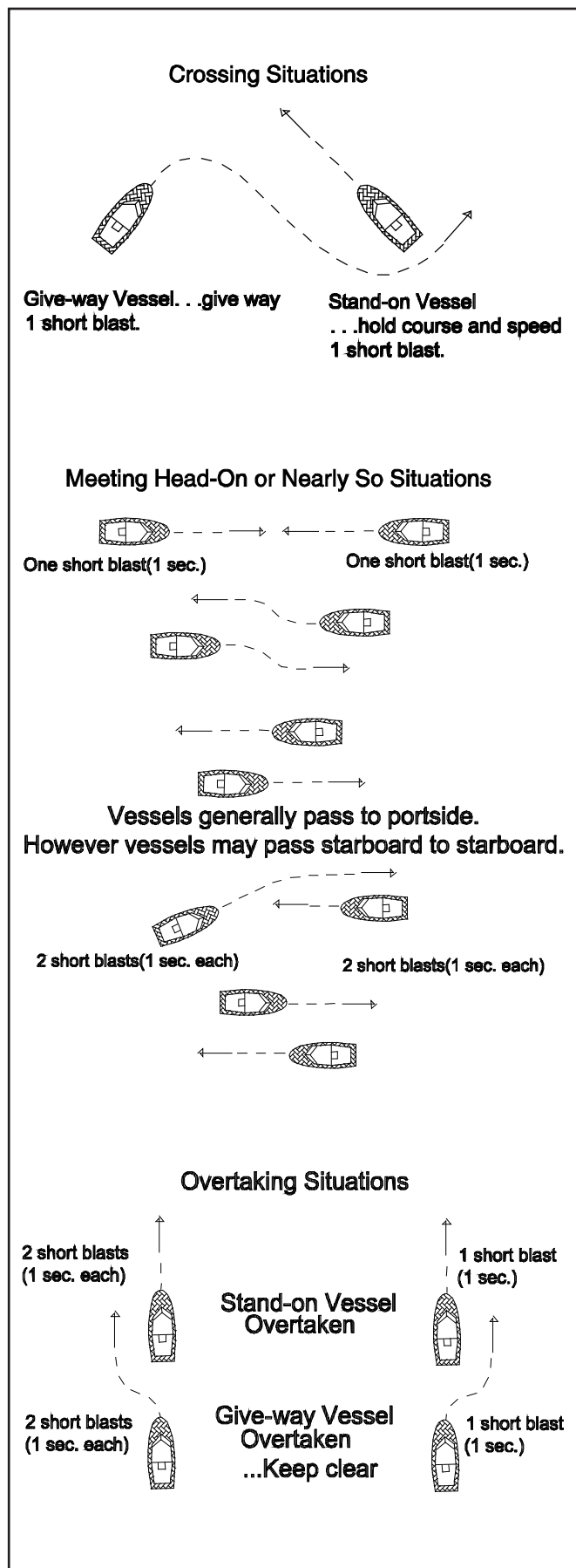

Navigational Aids Chart

REMEMBER THESE RULES

1. OVERTAKING - PASSING: Boat being passed has the right-of-way. KEEP CLEAR.
2. MEETING HEAD ON: Keep to the right.
3. CROSSING: Boat on right has the right-of-way. Slow down and permit boat to pass.

← PORT

Yield right-of-way to boats in your DANGER ZONE!



STARBOARD →

DANGER ZONE (Dead ahead to 2 points abaft your starboard beam)

STORM WARNINGS



RED FLAG
Small craft
(winds up to 33 knots)



2 RED FLAGS
Gale
(winds up to 47 knots)



SQUARE RED FLAG
BLACK BOX
(Storm)



2 SQUARE RED FLAGS
BLACK BOX
(Hurricane)

WHISTLE SIGNALS

- ONE LONG BLAST: Warning signal (Coming out of slip)
- ONE SHORT BLAST: Pass on my port side
- TWO SHORT BLASTS: Pass on my starboard side
- THREE SHORT BLASTS: Engine(s) in reverse
- FOUR OR MORE BLASTS: Danger signal

BRIDGE SIGNALS

SOUND

- VESSEL: Open
- BRIDGE: OK
- No
- VESSEL: Replies:
- RADIO: VHF CH. 13

VISUAL

- VESSEL: Open
- BRIDGE: OK
- No
- DAY (Flag) NIGHT (Lights)
- Same
- or
- Same

LATERAL AIDS AS SEEN ENTERING FROM SEAWARD

PORT SIDE ODD NUMBERED AIDS

- GREEN LIGHT ONLY
- FLASHING
- OCCULTING
- QUICK FLASHING
- ISOPHASE

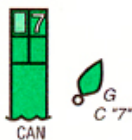
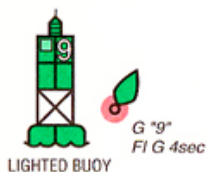

SAFE WATER MID-CHANNELS OR FAIRWAYS NO NUMBERS — MAY BE LETTERED

- WHITE LIGHT ONLY
- MORSE CODE
- Mo (A)

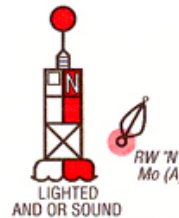

PREFERRED CHANNEL

NO NUMBERS — MAY BE LETTERED

- COMPOSITE GROUP FLASHING (2 + 1)

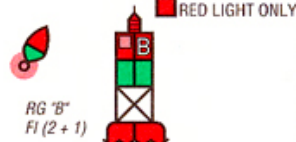
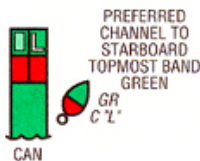
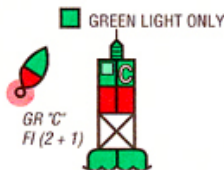

STARBOARD SIDE EVEN NUMBERED AIDS

- RED LIGHT ONLY
- FLASHING
- OCCULTING
- QUICK FLASHING
- ISOPHASE

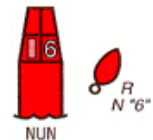
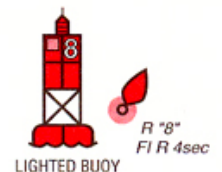

Operation

2.3 Pre-Cruise Check

Before Starting the Engines:

- Check the weather forecast and sea conditions before leaving the dock. Decide if the planned cruise can be made safely.
- Be sure all required documents are on board.
- Be sure all necessary safety equipment is on board and operative. This should include items like the running lights, spotlight, life saving devices, etc. Please refer to the Safety Equipment chapter for additional information on safety equipment.
- Make sure you have signal kits and flare guns aboard and they are current and in good operating condition.
- Be sure you have sufficient water and other provisions for the planned cruise.
- Leave a written message listing details of your planned cruise with a close friend ashore (Float Plan). The float plan should include a description of your boat, where you intend to cruise and a schedule of when you expect to arrive in the cruising area and when you expect to return. Keep the person informed of any changes in your plan to prevent false alarms. This information will tell authorities where to look and the type of boat to look for in the event you fail to arrive.
- Check the amount of fuel on board. Observe the "Rule of Thirds": one third of the fuel for the trip out, one third to return and one third in reserve. An additional 15% may be consumed in rough seas.
- Check the water separating fuel filters for leaks or corrosion.
- Check the crankcase oil level in each engine.
- Turn the battery switches on.
- Check the bilge water level. Look for other signs of potential problems. Monitor for the scent of fuel fumes.
- Test the automatic and manual bilge pump switches to make sure the systems are working properly. This is particularly important before running offshore.

- Have a tool kit aboard. The kit should include the following basic tools:

Hammer	Electrician's tape
Screwdrivers	Offset screwdrivers
Lubricating oil	Pliers
Jackknife	Adjustable wrench
Basic 3/8" ratchet set	Vise grip pliers
Hex key set	Needle nose pliers
Wire crimping tool	Wire connector Set
End wrench set	Medium slip-joint pliers
Diagonal cutting pliers	DC electrical test light



WARNING



THERE MUST BE AT LEAST ONE PERSONAL FLOTATION DEVICE ON BOARD FOR EVERY PERSON ON BOARD AND ONE THROW-OUT FLOTATION DEVICE. CHECK THE U.S. COAST GUARD STANDARDS FOR THE CORRECT TYPE OF DEVICE FOR YOUR BOAT.

- Have the following spare parts on board:

Extra light bulbs	Spark plugs
Fuses and circuit breakers	Main 12 volt fuses
Assorted stainless screws	Assorted stainless bolts
Flashlight and batteries	Drain plugs
Engine oil	Propellers
Fuel filters	Propeller hub kits
Fuel hose and clamps	Wire ties
Assorted hose clamps	Hydraulic steering fluid
Spare bilge pump	Rags
- Make sure all fire extinguishers are in position and in good operating condition.
- Check the engine and steering controls for smooth and proper operation. Be sure the shift controls are in the neutral position.
- Be sure the emergency stop lanyard is attached to the operator and the stop switch.
- Refer to the engine owner's manual for pre-operation checks specific to your engines.

Operation

2.4 Operating Your Boat

After Starting the Engines:

- Visibly check the engines to be sure there are no apparent water, fuel or oil leaks.
- Check the operation of the engine cooling systems by monitoring the water flowing from the bypass ports.
- Check the engine gauges. Make sure they are reading normally.
- Check the controls and steering for smooth and proper operation.
- Make sure all lines, cables, anchors, etc. for securing a boat are on board and in good condition. All lines should be coiled, secured and off the decks when underway.
- Have a safe cruise and enjoy yourself.

Remember:



When you operate a boat, you accept the responsibility for the boat, for the safety of passengers and for others out enjoying the water.

- Alcohol and any drugs can severely reduce your reaction time and affect your better judgement.
- Alcohol severely reduces the ability to react to several different signals at once.
- Alcohol makes it difficult to correctly judge speed and distance or track moving objects.
- Alcohol reduces night vision and the ability to distinguish red from green.



 **WARNING** 

YOU SHOULD NEVER OPERATE YOUR BOAT WHILE UNDER THE INFLUENCE OF ALCOHOL OR DRUGS.

- Make sure one other person on the boat is instructed in the operation of the boat.
- Make sure the boat is operated in compliance with all state and local laws governing the use of a boat.

 **WARNING** 

DO NOT OPERATE THE BOAT UNLESS IT IS COMPLETELY ASSEMBLED. KEEP ALL FASTENERS TIGHT. KEEP ADJUSTMENTS ACCORDING TO SPECIFICATIONS.

 **WARNING** 

FAILURE TO FOLLOW THE BREAK-IN PROCEDURE MAY RESULT IN REDUCED ENGINE LIFE OR EVEN SEVERE ENGINE DAMAGE IN YOUR OUTBOARD ENGINES. MAKE SURE YOU FOLLOW THE BREAK-IN PROCEDURE EXACTLY.

- Always operate the blower whenever the generator is running to remove fumes and help cool the equipment compartment.
- Avoid sea conditions that are beyond the skill and experience of you and your crew. Learn to understand weather patterns and indications for change. You should monitor NOAA weather broadcasts before leaving port and periodically while boating. If the weather deteriorates or a storm approaches, seek shelter in a safe harbor.
- Use caution during periods of reduced visibility due to weather or operation conditions. Reduce speed and designate a passenger to be a lookout for other boats, obstacles and navigational markers until you reach port or conditions improve.
- Your Everglades is a heavy boat that will produce a large wake at certain speeds. You are responsible for damage and injury caused by your boat's wake. Always observe no wake zones and be aware that your wake can endanger small vessels and their passengers. Always be courteous and slow down to reduce your wake when passing smaller boats.
- Before operating the boat for the first time, read the engine break-in procedures. The break-in procedures are found in the owner's manual for the engines. The manual is in the literature packet.

Operation

- As different types of engines could be used to power the boat, have the dealer describe the operating procedures for your boat. For more instructions on "How To Operate The Boat," make sure you read the instructions given to you in the owner's manual for the engines you have selected.

Notice:

For more instructions on safety, equipment and boat handling, enroll in one of the several free boating courses offered. For information on courses offered in your area go to the U.S. Coast Guard Boating Safety web site at www.uscgboating.org.

Notice:

If the running gear hits an underwater object, stop the engines. Inspect the propulsion system for damage. If the system is damaged, contact your dealer for a complete inspection and repair of the unit.

To stop the boat, follow this procedure:

- Allow the engines to drop to the idle speed.
- Make sure the shifting levers are in the neutral position.

Notice:

If the engines have been run at high speed for a long period of time, allow the engines to cool down by running the engines in the idle position for 3 to 5 minutes.

- Turn the ignitions to the OFF position.
- Raise the trim tabs to the full up position.

After Operation:

- If operating in saltwater, wash the boat and all equipment with soap and water. Flush the engines using freshwater. Refer to the engine owner's manual for instructions on flushing your outboard engines.
- Check the bilge area for debris and excess water.
- Fill the fuel tank to near full to reduce condensation. Allow enough room in the tank for the fuel to expand without being forced out through the vent.

- Turn off all electrical equipment except the automatic bilge pumps.
- If you are going to leave the boat for a long period of time, put the battery main switches in the OFF position and close all seacocks.
- Make sure the boat is securely moored.

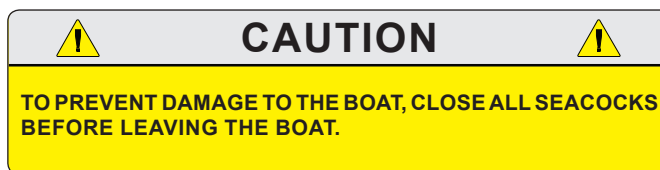

2.5 Docking, Anchoring & Mooring

Docking and Dock Lines

Maneuvering the boat near the dock and securing the boat requires skill and techniques that are unique to the water and wind conditions and the layout of the dock. If possible, position a crew member at the bow and stern to man the lines and assist in docking operations. While maneuvering close to the dock consideration must be given to the wind and current. You should anticipate the effect these forces will have on the boat and use them to help put the boat where you want it. It is important to practice in open water using an imaginary dock enough to develop a sense for the way your boat handles in a variety of docking scenarios. You must be able to foresee the possibilities and have solutions in mind before problems occur.

Approaching a dock or backing into a slip in high winds or strong currents requires a considerable amount of skill. If you are new to boat handling, you should take lessons from an experienced pilot to learn how to maneuver your boat in tight quarters in less than ideal conditions. You should also practice away from the dock during windy conditions.

Dock lines are generally twisted or braided nylon. Nylon is strong and stretches to absorb shock. It also has a long life and is soft and easy on the hands. The line's size will vary with the size of the boat. Typically a 30 to 40 foot boat will use 5/8 inch line and a 20 to 30 foot boat will use 1/2 inch line. The number of lines and their configuration will vary depending on the dock, the range of the tide and many other factors. Usually a combination of bow, stern and spring lines is used to secure the boat.

Maneuvering to a Dock or Slip

Notice:

Your boat is equipped with triple engines and electronic control systems. Depending on the control system options selected, the following conditions could apply that will affect the handling of your boat as you maneuver to the dock:

If you are using the engine shift and throttle controls to maneuver the boat, we recommend turning the center engine off and using the port and starboard engines to maneuver the boat to the dock or back it into a slip.

If your boat is equipped with a joystick integrated into the engine control system and you are using the joystick to maneuver the boat, you should leave all engines running while using the joystick control to maneuver the boat to the dock or back into the slip.

Note that most joystick controls will be deactivated if either throttle or shift control lever is moved while maneuvering the boat.

Electronic control system and joystick operation is unique to the engines installed on your boat. Operation manuals for the engines and control systems are included with this manual. You should read these manuals thoroughly and understand the control system in theory and operation before operating your boat. Additionally, your dealer should demonstrate the operation of the control system and instruct you in operating the controls properly.

Maneuvering to a Dock

Approach the dock slowly at a 30 to 40 degree angle. Whenever possible, approach against the wind or current. Turn the engines straight & shift to neutral when you feel you have enough momentum to reach the dock. Use reverse on the outboard engine while turning the steering wheel toward the dock to slow the boat and pull the stern toward the dock as the boat approaches. Straighten the engines and use both engines to stop the boat if it is still moving forward against the pilings. If you executed your approach properly, the boat will lightly touch the pilings at the

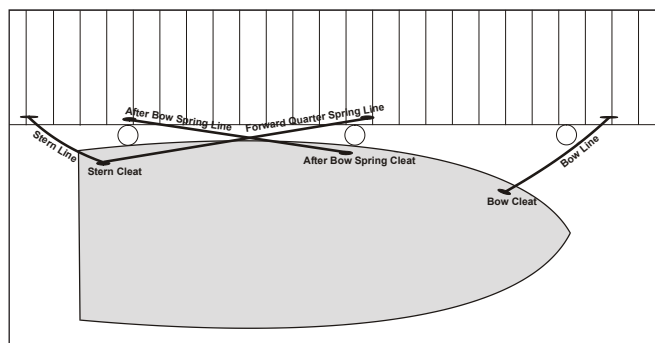

Securing The Boat Along Side A Dock (Typical)

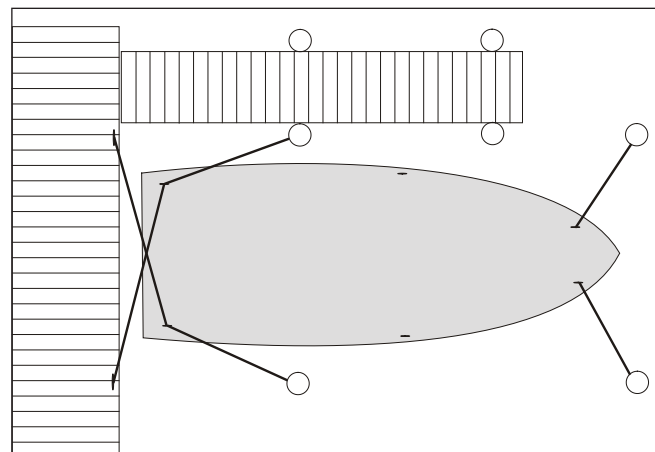

Securing The Boat In A Slip (Typical)

same time the forward momentum is stopped. Have the dock lines ready and secure the boat as soon as it stops. Use fenders to protect the boat while it is docked. Keep the engines running until the lines are secured.

Backing into a Slip

Approach the slip with the stern against the wind or current and the engines straight ahead. Use the engines and turn the steering wheel to maneuver the boat into alignment with the slip. Reverse the engines and slowly back into the slip. Shift from reverse to neutral frequently to prevent the boat from gaining too much speed. Move the stern right and left by shifting the engines in and out of gear or turning the wheel. When nearly in the slip all the way, straighten the engines and shift to forward to stop. Keep the engines running until the lines are secured.

Securing Dock Lines

Securing a boat that is tied along side the dock typically requires a bow and stern line and two spring lines. The bow and stern lines are usually secured to the dock at a 40° angle aft of the stern cleat and forward of the bow cleat. The after bow

Operation

spring line is secured to the dock at a 40° angle aft of the after bow spring cleat. The forward quarter spring is secured to the dock at a 40° angle forward of the stern cleat. The spring lines keep the boat square to the dock and reduce fore and aft movement while allowing the boat to move up and down with the tide.

Securing a boat in a slip is somewhat different. It typically requires two bow lines secured to pilings on each side of the bow, two stern lines secured to the dock and two spring lines that prevent the boat from hitting the dock. The bow lines are typically secured with enough slack to allow the boat to ride the tide. The stern lines are crossed. One line runs from the port aft boat cleat to the starboard dock cleat and the other line runs from the starboard aft boat cleat to the port cleat on the dock. The stern lines center the boat, control the forward motion and allow the boat to ride the tide. Two forward quarter spring lines typically are secured to the stern cleats and to mid ship pilings or cleats. The spring lines keep the boat from backing into the dock while allowing it to ride the tide.

Leaving the Dock

Always start the engines and let them warm up for several minutes before releasing the lines. Boats steer from the stern and it is important that you achieve enough clearance at the stern to maneuver the boat as quickly as possible. Push the stern off and maneuver such that you get stern clearance quickly. Proceed slowly until well clear of the dock and other boats.

Mooring

Approach the mooring heading into the wind or current. Shift to neutral when you have just enough headway to reach the buoy. Position a crew member on the bow to retrieve the mooring line with a boat hook and secure the line. Keep the engines running until the line is secured.

Leaving a Mooring

Start the engines and let them warm up for several minutes before releasing the mooring line. The boat will already be headed into the wind, so move it forward enough to loosen the line and untie it. Back the boat away from the mooring until you can see the buoy. Move the boat slowly away from the mooring.

Anchoring

Make sure the bitter end of the anchor line is attached to boat before dropping the anchor.

Bring the bow into the wind or current and put the engine in neutral. When the vessel comes to a stop, lower the anchor over the bow. Pay out anchor line so that it is at least 5 to 7 times the depth of the water and secure the line to a cleat. Use caution to avoid getting your feet or hands tangled in the line. Additional scope of 10 times the depth may be required for storm conditions. Check landmarks on shore or your GPS position to make sure the anchor is not dragging. If it is dragging, you will have to start all over. It is prudent to use two anchors at the bow if you are anchoring overnight or in rough weather.

After the anchor is set, the windlass must not be left to take the entire force from the anchor line. Boats lying to their anchor in a high swell or heavy weather conditions will snub on the line. This can cause slippage or apply excessive loads to the windlass. The line should always be made fast to a bow cleat to relieve the load on the windlass.

Do not set a bow and stern anchor when mooring, only anchor from the bow. The stern anchor will not allow the boat to swing with the current and wind. If you are anchored in a mooring with other boats, your boat will not swing with the other boats in the mooring, creating a potential for contact with another boat when the tide or wind changes. Additionally, having the stern to the wind or tide creates a potentially hazardous situation for the boat and crew.

Releasing the Anchor

Release the anchor by driving the boat slowly to the point where the anchor line becomes vertical. It should release when you pass that point. If the anchor doesn't release right away, stop the boat directly above the anchor and tie the line to the cleat as tight as possible. The up and down movement of the boat will usually loosen the anchor within a minute. Make sure you secure the anchor and properly stow the line before operating the boat.



WARNING





NEVER ANCHOR THE BOAT BY THE STERN. THE STERN OF THE BOAT IS VULNERABLE TO SWAMPING FROM WAVE ACTION AND WIND AND CURRENT WILL PUT MORE STRESS ON THE ANCHOR WHEN IT IS ATTACHED TO THE STERN. ONLY ANCHOR THE BOAT BY THE BOW

2.6 Controls, Steering or Propulsion System Failure

If the propulsion, control or steering system fails while you are operating the boat, bring the throttles to idle and shift to neutral. Decide whether you need to put out the anchor to prevent the boat from drifting or to hold the bow into the seas. Investigate and correct the problem if you can. Turn the engine off before opening the engine cowling to make repairs. If you are unable to correct the problem, call for help.

If only one engine has failed, you can usually run home on the other engines. Be careful not to apply too much power to the engines that are running. When one or more engines are not operating on a multi engine boat, the remaining engine or engines are over propped and can be overloaded if too much throttle is applied. You should contact your dealer or the engine manufacturer for the maximum power settings when running without one engine.

	CAUTION	
ENGINE DAMAGE CAN RESULT IF PROPER EMERGENCY PROCEDURES ARE NOT FOLLOWED ON MULTI ENGINE BOATS. THIS IS PARTICULARLY IMPORTANT ON TRIPLE ENGINE BOATS WITH ELECTRONIC STEERING. REFER TO THE ENGINE AND CONTROL SYSTEM MANUALS. ALWAYS FOLLOW THE EMERGENCY PROCEDURES RECOMMENDED BY THE ENGINE MANUFACTURER.		

2.7 Collision



If your boat is involved in a collision with another boat, dock, piling or a sandbar, your first priority is to check your passengers for injuries and administer first aid if necessary. Once your passengers situations are stabilized, thoroughly inspect the boat for damage. Check below decks for leaks and the control systems for proper operation. Plug all leaks or make the necessary repairs to the control systems before proceeding slowly and carefully to port. Request assistance if necessary. Haul the boat and make a thorough inspection of the hull and running gear for damage.



2.8 Grounding, Towing & Rendering Assistance



The law requires the owner or operator of a vessel to render assistance to any individual or vessel in distress, as long as his vessel is not endangered in the process.

If the boat should become disabled or if another craft that is disabled requires assistance, great care must be taken. The stress applied to a boat during towing may become excessive. Excessive stress can damage the structure of the boat and create a safety hazard for those aboard.

Freeing a grounded vessel or towing a boat that is disabled, requires specialized equipment and knowledge. Line failure and structural damage caused by improper towing have resulted in fatal injuries. Because of this, we strongly suggest that these activities be left to those who have the equipment and knowledge, e.g., the U.S. Coast Guard or a commercial towing company, to safely accomplish the towing task.

	DANGER	
THE MOORING CLEATS ON EVERGLADES BOATS ARE NOT DESIGNED OR INTENDED TO BE USED FOR TOWING PURPOSES. THESE CLEATS ARE SPECIFICALLY DESIGNED AS MOORING CLEATS FOR SECURING THE BOAT TO A DOCK, PIER, ETC. DO NOT USE THESE FITTINGS FOR TOWING OR ATTEMPTING TO FREE A GROUNDED VESSEL.		

	WARNING	
WHEN TOWING OPERATIONS ARE UNDERWAY, HAVE EVERYONE ABOARD BOTH VESSELS STAY CLEAR OF THE TOW LINE AND SURROUNDING AREA. A TOW LINE THAT SHOULD BREAK WHILE UNDER STRESS CAN BE VERY DANGEROUS AND COULD CAUSE SERIOUS INJURY OR DEATH.		

	WARNING	
RUNNING AGROUND CAN CAUSE SERIOUS INJURY TO PASSENGERS AND DAMAGE TO A BOAT AND ITS UNDERWATER GEAR. IF YOUR BOAT SHOULD BECOME GROUNDED, DISTRIBUTE PERSONAL FLOTATION DEVICES AND INSPECT THE BOAT FOR POSSIBLE DAMAGE. THOROUGHLY INSPECT THE BILGE AREA FOR SIGNS OF LEAKAGE. AN EXPERIENCED SERVICE FACILITY SHOULD CHECK YOUR UNDERWATER GEAR AT THE FIRST OPPORTUNITY. DO NOT CONTINUE TO USE YOUR BOAT IF THE CONDITION OF THE UNDERWATER EQUIPMENT IS QUESTIONABLE.		

2.9 Flooding or Capsizing

Boats can become unstable if they become flooded or completely swamped. You must always be aware of the position of the boat to the seas and the amount of water in the bilge. Water entering the boat through the transom door or over the stern gunnels can usually be corrected by closing the door and turning the boat into the waves. If the bilge is flooding because of a hole in the hull or a defective hose, you may be able to plug it with rags, close the thru-hull valve or assist the pumps by bailing with buckets. Put a mayday call in to the Coast Guard or nearby boats and distribute life jackets as soon as you discover your boat is in trouble.

If the boat becomes swamped and capsizes, you and your passengers should stay with the boat as long as you can. It is much easier for the Coast Guard, aircraft or other boats to spot, than people in the water. If your boat is equipped with an EPIRB, make sure it is activated. When activated, EPIRBs will send distress code homing beacons that allow Coast Guard aircraft to identify your boat and find you quickly.

2.10 Fishing

Fishing can be very exciting and distracting for the operator when the action gets intense. You must always be conscious of the fact that your primary responsibility is the safe operation of your boat and the safety of your passengers and other boats in the area.

You must always make sure the helm is properly manned and is never left unattended while trolling. If your boat is equipped with a tower, caution and good common sense must be exercised whenever someone is in the tower. Remember, weight in the tower raises the boat's center of gravity and the boat's motion is greatly exaggerated for the person in a tower.

If you are fishing in an area that is crowded with other fishing boats, it may be difficult to follow the rules of the road. This situation can become especially difficult when most boats are trolling. Being courteous and exercising good common sense is essential. Avoid trying to assert your right-of-way and concentrate on staying clear and preventing tangled or cut lines and other unpleasant encounters with other boats. Also keep in mind that fishing line wrapped around a propeller shaft can damage seals in the engine lower unit.

2.11 Tower Operation (Optional)

Your boat could be equipped with an optional fabricated aluminum tower or upper helm station. Towers are normally equipped with full engine controls, trim tab controls, compass, engine alarms, stop and start buttons, emergency stop switch and tachometers. This allows for complete operation of the boat from the tower.

Operation of the Upper Station Controls

The engines should be started at the lower helm. Monitor the gauges to make sure all systems are normal and the engines have been allowed to warm up slightly before proceeding to the tower helm. The ignition or restart switches on the tower are only used to restart an engine in the event it should stall. The shift controls must be in neutral for the start switches to be functional.

Electronic engine controls are equipped with a station transfer button that allows the operator to transfer control from one station to another with the push of a button. Always make sure that you activate the controls as soon as you reach the upper helm station.



Refer to the Control Systems chapter and the electronic engine control owner's manual for more information on the control system operation and selecting the controls on boats with dual stations.

The following is a list of safety precautions for tower operation:



- Do not operate the boat from the tower in rough sea conditions. The boat's motions are exaggerated in the tower and this motion may become excessive in rough seas.
- Be careful when using the trim tabs from the tower. The reaction of the trim tabs will be exaggerated in the tower. Use small tab corrections and wait ten (10) seconds for the tabs to react. Keep making small corrections until the hull is at the desired attitude.
- Do not overload the tower. Most towers are designed to hold the weight of only two average-sized people. Weight in the tower raises the boat's center of gravity. Too much weight in the tower could make the boat unstable.
- Do not operate the boat in tight quarters, such as marinas, from the tower. The operator is isolated from the boat while in the tower and will not be able to assist in docking procedures.

Operation

- Always pay close attention to your grip and footing on tower ladders. Your ability to achieve a good grip and proper footing is reduced in wet or rough weather. Therefore, the tower should be avoided in these conditions.
- Only operate the boat from the tower in familiar waters or where running aground is not a possibility. Running aground while operating the boat from the tower could result in severe injury.
- Always be alert for waves and boat wakes when operating the boat from the tower. Remember that the boat's motions are exaggerated in the tower.
- Good common sense and judgment must be exercised at all times when operating a boat from the tower.
- If an engine alarm sounds, immediately put the boat in NEUTRAL and shut OFF the engine(s), if safe to do so, until the problem is found and corrected.
- Always put the boat in NEUTRAL before moving to and from the tower helm and cockpit.
- Make sure to approach the person from the downwind side and maneuver the boat so the propellers are well clear of the person in the water.
- Turn off the engines when the person is alongside and use a ring buoy with a line attached, a paddle or boat hook to assist him to the boat. Make sure you don't hit him with the ring buoy or the boat.
- Pull the person to the boat and assist him on board.
- Check the person for injuries and administer first aid if necessary. If the injuries are serious, call for help. Refer to the Safety chapter for more information on first aid and requesting emergency medical assistance.

 **WARNING** 

GOOD COMMON SENSE, JUDGMENT AND EXTREME CAUTION MUST BE EXERCISED WHEN OPERATING A BOAT WITH SOMEONE IN THE TOWER. DO NOT ALLOW ANYONE IN THE TOWER WHEN THE WATER IS ROUGH OR WHEN OPERATING IN UNFAMILIAR WATERS WHERE RUNNING AGROUND IS A POSSIBILITY. REMEMBER, WEIGHT IN THE TOWER RAISES THE BOAT'S CENTER OF GRAVITY AND THE BOAT'S MOTION IS GREATLY EXAGGERATED FOR THE PEOPLE IN THE TOWER.

 **WARNING** 

MOVING PROPELLERS ARE DANGEROUS. THEY CAN CAUSE DEATH, LOSS OF LIMBS OR OTHER SEVERE INJURY. DO NOT USE THE SWIM PLATFORM OR SWIM LADDER WHILE THE ENGINES ARE RUNNING. STOP THE ENGINES IF DIVERS OR SWIMMERS ARE ATTEMPTING TO BOARD. ALWAYS PROPERLY STORE THE LADDER BEFORE STARTING THE ENGINES.

2.12 Man Overboard

If someone falls overboard, you must be prepared to react quickly, particularly when you are offshore. The following procedures will help you in recovering a person that has fallen overboard.

- Immediately stop the boat and sound a man overboard alarm and have all passengers point to the person in the water.
- Circle around quickly and throw a cushion or life jacket to the person, if possible and another to use as a marker.
- Keep the person on the driver side of the boat so you can keep him in sight at all times.

2.13 Trash Disposal

The discharge of plastic trash or trash mixed with plastic is illegal anywhere in the marine environment. U.S. Coast Guard regulations also restrict the dumping of other forms of garbage. Regional, state and local restrictions on garbage discharges also may apply.

Responsible boaters store refuse in bags and dispose of it properly on shore. You should make sure your passengers are aware of the local waste laws and the trash management procedure on your boat. Refer to the placard mounted on your boat for more specific information regarding solid waste disposal.

Federal law requires that vessels of 26 feet or longer must display in a prominent location, a durable placard at least 4 by 9 inches notifying the crew and passengers of the discharge restrictions (Marpol Treaty). A label for this purpose has been shipped with the boat and is attached to the port side of the cockpit. It is the boat owner's responsibility to make sure this placard remains mounted and legible in accordance with the law.

Operation

2.14 Yacht Certification Plate

Coast Guard rules require boats less than 20 feet (6 meters) to display a gross weight and person-capacity plate provided by the manufacturer. The person/load capacity is determined by the US Coast Guard.

Boat manufacturers in the National Marine Manufacturers Association (NMMA) program will display a gross weight and person-capacity plate on boats up to 26 feet (7.9 meters). Larger boats, including your boat, will display a Yacht Certification plate indicating compliance with the NMMA and U.S. Coast Guard requirements instead of a capacity plate.

The yacht certification plate is usually located near the helm in clear view of the operator.

2.15 Transporting Your Boat

Your Everglades is a large boat and should only be trailered by professionals that have the knowledge and equipment to move large boats without causing damage.

You should contact your dealer or the Everglades Boats Customer Service Department if you are planning to transport your boat and have any questions in regard to the proper equipment and support for the hull.

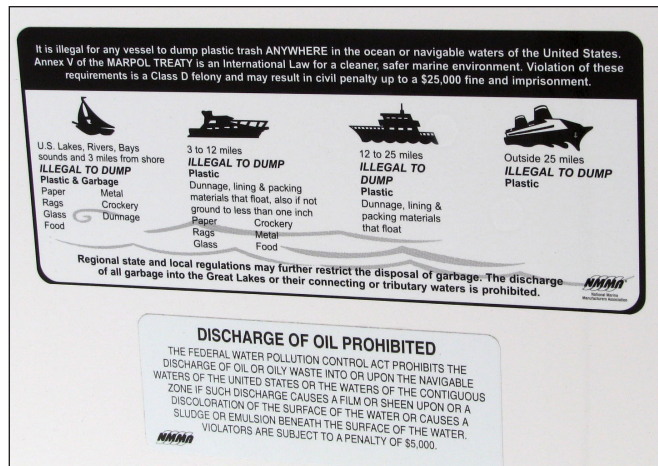

Trash Disposal & Discharge of Placard on Port Side of Cockpit



Yacht Certification

CAUTION



BOATS HAVE BEEN DAMAGED BY TRAILERS THAT DON'T PROPERLY SUPPORT THE HULL. ALWAYS MAKE SURE THE TRAILER BUNKS AND PADS ARE ADJUSTED SO THEY ARE NOT PUTTING EXCESSIVE PRESSURE ON THE LIFTING STRAKES AND ARE PROVIDING ENOUGH SUPPORT FOR THE HULL. HULL DAMAGE RESULTING FROM IMPROPER TRAILER SUPPORT IS NOT COVERED BY THE EVERGLADES WARRANTY.



PROPULSION SYSTEM

3.1 General

Your Everglades is designed to be powered with 4-cycle outboard motors. 4-cycle outboard engines do not use an oil injection system and are not equipped with remote oil tanks. They have an oil sump in the crankcase that must be kept full of the type of oil recommended by the engine manufacturer. The oil must be checked before each use and changed regularly.

Each manufacturer of the various outboard motors provides an owner's information manual with its product. It is important that you read the manual(s) very carefully and become familiar with the proper care and operation of the engines and drive systems. A warranty registration card has been furnished with each new engine and can be located in the engine owner's manual. All information requested on this card should be filled out completely by the dealer and purchaser and then returned to the respective engine manufacturer as soon as possible.

	WARNING	
<p>DO NOT ATTEMPT TO SERVICE ANY ENGINE OR DRIVE COMPONENT WITHOUT BEING TOTALLY FAMILIAR WITH THE SAFE AND PROPER SERVICE PROCEDURES. CERTAIN MOVING PARTS ARE EXPOSED AND CAN BE DANGEROUS TO SOMEONE UNFAMILIAR WITH THE OPERATION AND FUNCTION OF THE EQUIPMENT.</p>		

	WARNING	
<p>DO NOT INHALE EXHAUST FUMES! EXHAUST CONTAINS CARBON MONOXIDE THAT IS COLORLESS AND ODORLESS. CARBON MONOXIDE IS A DANGEROUS GAS THAT IS POTENTIALLY LETHAL.</p>		

3.2 Drive System Corrosion

Each outboard motor is a complete drive system with the gear case being just forward of the propeller and connected to the power head with a vertical drive shaft. All engines require some maintenance. Routine maintenance recommended for your engine is outlined in the engine



Outboard Engines

owner's manual. Routine maintenance is normally the primary concern unless the boat is to be kept in saltwater for extended periods of time. Then the main concerns are marine growth and galvanic corrosion.

Marine growth occurs when components are left in the water for extended periods and can cause poor performance or permanent damage to the exposed components. The type of growth and how quickly it occurs is relative to the water conditions in your boating area. Water temperature, pollution, current, etc. can have an effect on marine growth.

Galvanic corrosion is the corrosion process occurring when different metals are submerged in an electrolyte. Seawater is an electrolyte and submerged engine components must be properly protected. Outboard motors are equipped with sacrificial anodes to prevent galvanic corrosion problems. The anodes must be monitored and replaced as necessary. For locations and maintenance, please refer to the engine owner's manual. When leaving the boat in the water, tilt the motors as high as possible. This will decrease the risk of marine growth around the cooling inlets, propeller and exhaust ports and damage from galvanic corrosion.



CAUTION



DO NOT PAINT THE OUTBOARD MOTOR WITH ANTI-FOULING PAINTS DESIGNED FOR BOAT HULLS. MANY OF THESE PAINTS CAN CAUSE SEVERE DAMAGE TO THE ENGINE. CONTACT YOUR EVERGLADES DEALER OR ENGINE MANUFACTURER FOR INFORMATION ON THE PROPER PAINTING PROCEDURES.

3.3 Engine Lubrication

4-cycle outboard engines incorporate a pressure-type lubrication system with an oil sump in the crankcase that must be kept full of the type and grade of oil recommended by the engine manufacturer. It is normal for 4-cycle engines to consume a small amount of oil. Therefore, the oil must be checked before each use and changed at regular intervals as instructed by the engine owner's manual.

Notice:

Always monitor the oil level in the crankcase and only use the type of oil specified by the engine manufacturer. Yamaha engines specify Yamalube engine oil.

3.4 Engine Cooling System

Outboard engines are raw water (seawater) cooled. Water is pumped through the water inlets, circulated through the engine block and relinquished with the exhaust gases through the propeller hub. The water pump uses a small impeller made of synthetic rubber. The impeller and water pump cannot run dry for more than a few seconds. In most outboard motors, some cooling water is diverted through ports below the engine cowling. This allows the operator to visually check the operation of the cooling system. When the engine is started, always check for a steady stream of water coming out of those ports.

Notice:

If the boat is used in salt or badly polluted water, the engines should be flushed after each use. Refer to the engine owner's manual for the proper engine flushing procedure.



CAUTION



NEVER RUN AN OUTBOARD MOTOR WITHOUT WATER FLOWING TO THE WATER PUMP. SERIOUS DAMAGE TO THE WATER IMPELLER OR ENGINE COULD RESULT.

3.5 Propellers

The propellers convert the engine's power into thrust. They come in a variety of styles, diameters and pitches. All boats powered by Yamaha engines are equipped with Yamaha propellers. The propellers that will best suit the needs of your boat will depend somewhat on your application and expected average load. Propeller sizes are identified by two numbers stamped on the prop in sequence. The 1st number in the sequence (example 14" x 21") is the diameter of the propeller and the 2nd number is the pitch. Pitch is the theoretical distance traveled by the propeller in each revolution.

Always repair or replace a propeller immediately if it has been damaged. A damaged and therefore out of balance propeller can cause vibration that can be felt in the boat and could damage the engine gear assembly. Refer to the engine owner's manual for information on propeller removal and installation.

3.6 Performance Issues & Propellers

It is extremely important that the boat is propped to run at or very near the recommended top RPM with an average load. If the top RPM is above or below the recommend range, the propellers must be changed to prevent loss of performance and possible engine damage.

Your boat is equipped from the factory with counter rotating engines that are mounted to achieve quicker planning and optimum performance. Therefore, the left rotation engine is mounted on the port side of the transom and the right rotation engine is mounted on the starboard side. On boats equipped three engines, the center engine is typically a right rotation engine. You should make sure that each propeller matches the rotation of the engine.

Notice:

Before changing propellers to correct boat performance problems, be sure other factors such as engine tuning, bottom and running gear growth, etc. are not the source of performance changes. Always be sure the load conditions are those normally experienced, before changing propellers.

Propulsion System

Your boat was shipped with propellers that typically provide optimum performance for your boat. However there are factors that can affect performance and propeller requirements.

Some are as follows:

- You should be sure the load conditions are those normally experienced. If the boat ran in the required RPM range when it was new and you have not added any additional gear or heavy equipment and have not damaged the propellers, there is a good chance the propellers are not the problem.
- The addition of heavy equipment like a tower, life rafts, additional coolers, etc., will cause additional load on the engines. Consequently, different propellers may be required.
- Boats operated at high altitudes (above 2000 feet). Engines operated at high altitudes will not be able to develop as much horsepower as they do at or near sea level. Consequently, different propellers may be required.

Notice:

Outboard engines can be damaged and the warranty voided if the boat is not propped correctly. Always consult your Everglades dealer or authorized engine service dealer when making changes to the propellers or if the boat does not run near the top recommended RPM.



Yamaha Saltwater Series Propeller

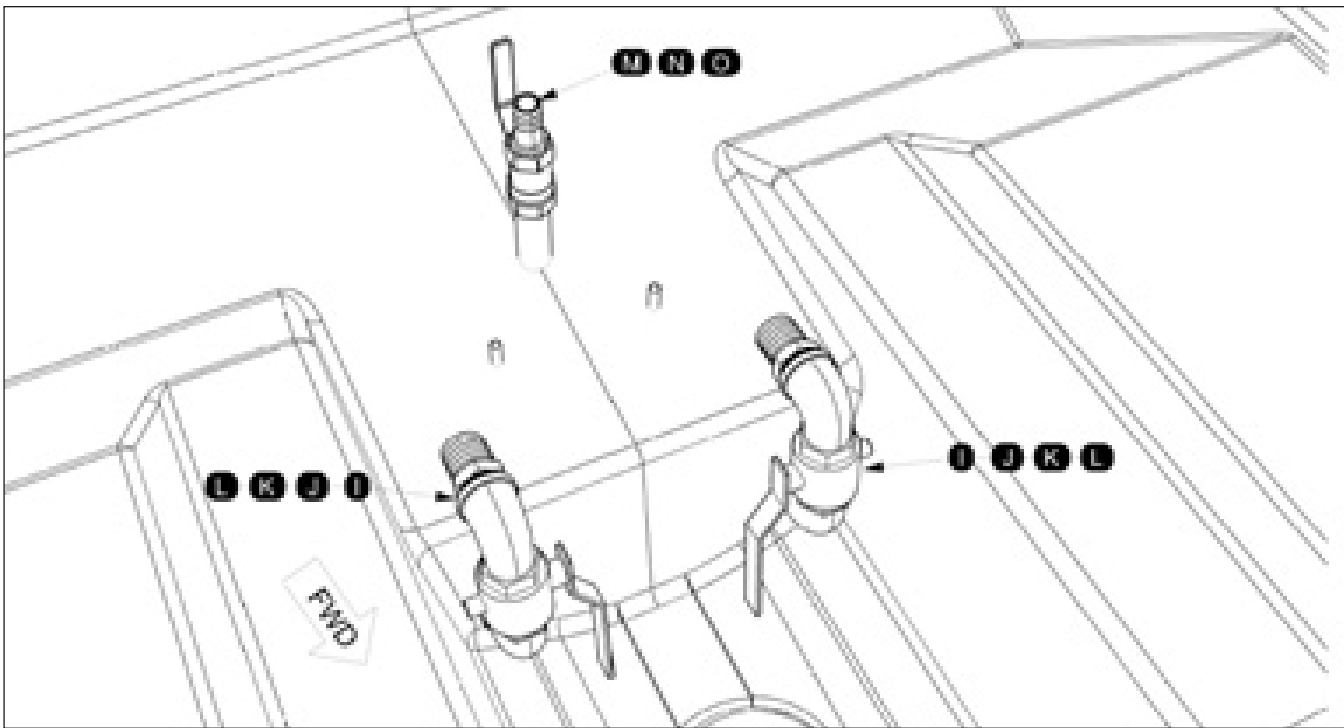

Hull Ventilation Thru-Hull Valves In Aft Bilge

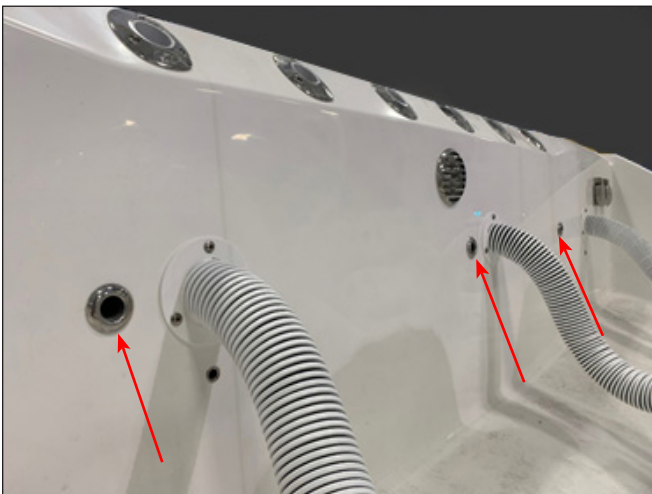

Aft Cockpit Wall Vent Fittings

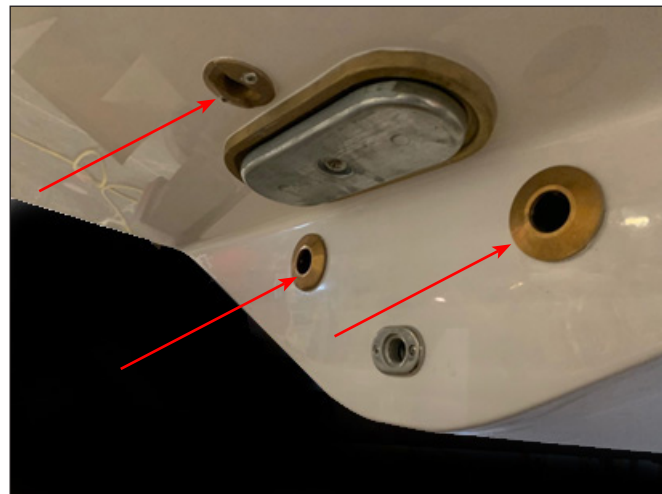

Hull Bottom Vent Fittings

3.7 Hull Ventilation Thru-Hulls

For optimum performance the hull includes three ventilation thru hulls. These fittings provide ventilation from the aft cockpit wall to the aft center line portion of the running surface of hull bottom. For optimum planning performance ensure that

the seacocks are fully opening and that there is no blockage of the ventilation tubes running up to the aft wall of the cockpit. The image above describes the location of the thru hulls. Two are located under the generator and one is located aft of the generator.



Typical Analog & Graphical Engine Monitoring Screen On a Garmin Display

3.8 Engine Instrumentation

The helm station is equipped with a set of engine instruments and/or alarms. These instruments allow the operator to monitor the operational condition of the engines. Close observation of these instruments allows the operator to operate the engines at the most efficient level and could save them from serious costly damage.

Most Everglades boats are equipped with Yamaha engines and Command Link Plus® LCD multifunction displays. Triple or triple engine boats typically have one display that monitors all engines.

This system can be integrated with the optional electronic navigation equipment installed on your boat and/or the Yamaha Helm Master control system. A brief description of the Command Link Plus® system integrated gauges and their basic functions are listed in this section. Other functions that are dependent on the electronics and control system installed on your boat may be available. Refer to the Yamaha engine, Command Link Plus® and Helm Master owner's manuals and

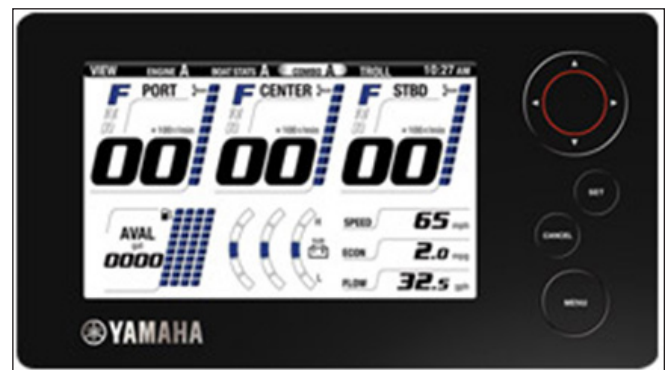

Yamaha Command Link Plus® / Typical Triple Engine Display

the manuals for the electronics installed on your boat for detailed information on the operation of the instruments and additional functions available.

The instrumentation is unique to the type of out-board motors installed on your Everglades.



Typical Digital Engine Monitoring Screen On a Garmin Display

Some or all of the following gauges may be present.

Tachometers



The tachometers display the speed of the engines in revolutions per minute (RPM). This speed is not the boat speed or necessarily the speed of the propeller.

The tachometer display also contains the engine trim meters, oil pressure indicator, water pressure, water temperature, volt meters and the overheat warning indicator.



optional GPS or depth sounder triducer, if these options are installed in your boat. Refer to the engine gauge and electronics operating manuals for more information on the speedometer options available for your boat.

Overheat Warning Indicator

The temperature warning indicates that the temperature of the engine is too high. A sudden increase in the temperature could indicate an obstructed water inlet or an impeller failure. On Yamaha engines the overheat warning indicator is built into the LCD display. It will start to blink and sound an alarm if the engine temperature is too high.

 **CAUTION** 

NEVER EXCEED THE MAXIMUM RECOMMENDED OPERATION RPM OF THE ENGINES. MAINTAINING MAXIMUM OR CLOSE TO MAXIMUM RPM FOR EXTENDED PERIODS CAN REDUCE THE LIFE OF THE ENGINES.

 **CAUTION** 

CONTINUED OPERATION OF AN OVERHEATED ENGINE CAN RESULT IN ENGINE SEIZURE. IF AN UNUSUALLY HIGH TEMPERATURE READING OCCURS, SHUT THE ENGINE OFF IMMEDIATELY. THEN INVESTIGATE AND CORRECT THE PROBLEM

Speedometer

Yamaha Command Link Plus® speedometers can indicate boat speed via the engine pickup or an

Propulsion System

Fuel Gauge

The fuel gauge indicates the amount of fuel in the fuel tank. On boats equipped with Yamaha Command Link Plus®, the fuel gauge is built into the LCD Display. The fuel indicator on the display will begin to blink if the fuel in the tank drops too low. The system can monitor up to 4 fuel or water tanks.

Voltmeters

The voltmeters display the voltage for the battery and the charging system for each engine. The normal voltage is 11 to 12 volts with the engines off and 13 to 14.5 volts with the engines running. The Yamaha engine voltmeter is built into the LCD display. It will begin to blink if the voltage in the battery drops too low.

Hour Meters

The hour meters keep a record of the operating time for each engine.

Engine Tilt/Trim Gauges

The tilt/trim gauges monitor the position of each outboard engine. The upper range of the gauge indicates the tilt, which is used for trailering and shallow water operation. The lower range indicates the trim position. This is the range used to adjust the hull angle while operating your boat on plane. The Yamaha engine trim indicator is built into the LCD display. Refer to the engine and Command Link Plus® owner's manuals for more information on the operation of the outboard power tilt and trim.

Engine Alarms

All outboards are equipped with an audible alarm system mounted in the helm area that monitors selected critical engine systems. The alarm will sound if one of these systems begins to fail. Refer to the engine owner's manual for information on the alarms installed with your engines.



CAUTION



IF THE ENGINE ALARM SOUNDS, IMMEDIATELY SHUT OFF THE ENGINE UNTIL THE PROBLEM IS FOUND AND CORRECTED.



Compass

Fuel Management

Fuel management systems are standard equipment with some outboard engines. On Yamaha engines, the fuel management gauge is built into the Command Link Plus® display and can monitor miles per gallon, total gallons used and total gallons remaining.

If you have a fuel management system installed on your boat, Refer to the engine or fuel management manual for detailed information on that system.

Compass

All boats are equipped with a compass on the top of the instrument panel. The compass cannot be adjusted accurately at the factory as it must be compensated for the influence of the electrical equipment and electronics unique to your boat. Therefore, the compass should be adjusted by a professional after the electronics and additional electrical accessories are installed and before operating the boat. To adjust the compass for your area, read the instructions on "Compass Compensation" given to you in the literature packet.

Instrument Maintenance

Electrical protection for instruments and ignition circuitry is provided by a set of fuses or circuit breakers located on each engine. The ignition switches should be sprayed periodically with a contact cleaner/lubricant. The ignition switches and all instruments, controls, etc. should be protected from the weather when not in use. Excessive exposure can lead to gauge and ignition switch difficulties.

HELM CONTROL SYSTEMS

4.1 General

The helm controls consist of three systems: the engine throttle and shift controls, the steering system and the trim tab control switches. These systems provide the operator with the ability to control the direction and attitude of the boat from the helm station.

In addition to the primary helm controls, your boat could be equipped with an optional bow thruster that provides the operator additional control of the bow while docking or anchoring the boat in tight quarters or high winds and strong currents.

Each manufacturer of the control components provides an owner's manual with its product. It is important that you read the manuals and become familiar with the proper care and operation of the control systems.

4.2 Engine Throttle & Shift Controls

The shift and throttle controls on your boat may vary depending on the engines used and control system selected. Refer to the engine or control manuals for specific information on the controls installed on your boat.

Electronic engine controls are standard on large outboard engines. The following control description is typical of most triple and triple engine electronic control systems.

Triple Engine Controls

The helm is designed for a binnacle style control with a single lever for the port and center engines and another single lever for the starboard engine. The electronic control system consists of three major components: the electronic control head, display screens and keypad, control processors and applicable harnesses. The controls are completely electronic and there are no cables.

Each lever operates as a gearshift and a throttle. General control lever operation will include a position for neutral (straight up and down or slightly aft of vertical), a forward position (the 1st detent forward of neutral) and a reverse position (the 1st



Typical Yamaha Triple Engine Control

detent aft of neutral). Advancing the control lever beyond the shift range advances the throttle in forward or reverse. Each control is equipped with a means of permitting the engines to be operated at a higher than normal idle RPM while in neutral for cold starting and warm-up purposes. The control levers are equipped with adjustable control head detent and friction settings.

On triple engine boats, an engine selector switch on the binnacle control panel allows the operator to select which engines provide the forward and reverse thrust, for optimum control and handling. LED lights on the control indicate which engines are selected.

Typically, the center engine is disengaged during docking and while maneuvering in tight quarters to improve handling. It can also be disengaged while

Helm Control Systems

operating at slow or trolling speeds to save fuel. If an engine fails, the selector switch can be used to operate the boat on the two remaining engines or just the center engine, if it is available.

When only the port and starboard engines are selected, the port lever will control the port engine and starboard lever controls the starboard engine. The center engine will remain in neutral.

When all three engines are selected during normal operations, the center and port engines are controlled by the port control handle. The computer automatically synchronizes the rpm of the center and port engines whenever all three engines are selected. Another engine synchronizer feature built into the control system can be selected to synchronize all three engines.

Control Functions and Features

Most electronic engine controls and key pad have integrated switches and indicator lights which allow the operator to control all aspects of the boat's propulsion system. LED lights on the control pad indicate that the control is activated and the engines can be started.

The most common features activated or monitored by the keypad are:

- Starter lockout, which prevents the engine from being started in gear.
- Gear lockout, which allows the engine RPM to be advanced in neutral safely.
- Battery voltage warning indicator that warns the operator of high or low voltage supplied to the system (audible alarm).
- An engine synchronization feature that automatically keeps all engines at the same RPM while cruising. Refer to Engine Synchronizing in this section and the control systems owner's manual for more information regarding engine synchronization.
- Trolling feature that allows the operator to increase the engine speed in 50 RPM increments while operating at trolling speeds.
- Station selection (a separate button on some controls) that allows the operator to transfer control from one station to another with the push of a button on boats with two helm stations. Each station must be selected by the operator before the controls will operate from that station.





Typical Yamaha Helm Master Engine Binnacle Control



Yamaha Helm Master Control Key Pad & Station Transfer Button

These features and others not mentioned require specific procedures to activate and operate them properly. Some of the procedures and features

are unique to the engines and other options installed on your boat. It is essential that you read the owner's manual for the controls and be completely familiar with their operation before using your boat.

 **CAUTION** 

ALWAYS RETURN THE ENGINE THROTTLE LEVER TO THE EXTREME LOW SPEED POSITION AND ALLOW THE ENGINES TO DROP TO IDLE RPM BEFORE SHIFTING. NEVER SHIFT THE UNIT WHILE ENGINE SPEED IS ABOVE IDLE RPM.

Engine Synchronizer

During most operations of triple engine powered boats, it is advantageous for all engines to be operated at the same RPM. This reduces noise and vibration and can increase engine efficiency. Setting the throttles so that the engines are running the same RPM (synchronized) can be done by listening to the engine sounds at low RPM and with the automatic synchronizer feature built into the electronic engine controls when the engines are operating above 1000 RPM. Attempting to synchronize the engines solely by using the tachometer readings or control lever placement generally will not work. When the engines are in proper synchronization, the throttle levers may not necessarily be even.

Refer to the engine or control owner's manuals for more information on the engine synchronizer and other features for the electronic controls installed on your boat.

4.3 Neutral Safety Switch

Every control system has a neutral safety switch incorporated into it. This device prohibits an engine from being started while the shift lever is in any position other than the neutral position. If the engine will not start, slight movement of the shift lever may be necessary to locate the neutral position and disengage the safety cutout switch. Control adjustments may be required to correct this condition should it persist. See your Everglades dealer for necessary control adjustments.



The neutral safety switches should be tested periodically to ensure that they are operating properly. To test the neutral safety switches, make sure the engines are tilted down and move the shift levers to the forward position.

Make sure the throttle control levers are not advanced past the idle position. Press the Start Button or turn the key just long enough to briefly engage the starter for the engine.

Notice:

Some outboard control systems are equipped with a computer controlled start feature that will keep the starter engaged until the engine starts if the neutral safety switch fails and allows the starter to engage.

The starter should not engage for any engine. Repeat this test with the shift levers in reverse and the engine throttles at idle. Again, the starter should not engage for any engine. If the starter for any engine engages with the shift controls in any position other than the neutral position, then the neutral safety switch is not functioning properly and you should contact your dealer to have the neutral safety switch repaired by a qualified marine mechanic before using the boat. If an engine starts in gear during this test, immediately move the control lever to the neutral position and turn the engine off.

 **WARNING** 

IN SOME SITUATIONS, IT MAY BE POSSIBLE TO ACCIDENTALLY START THE ENGINES IN GEAR WITH THE THROTTLES ABOVE IDLE IF THE NEUTRAL SAFETY SWITCH IS NOT OPERATING PROPERLY. THIS WOULD CAUSE THE BOAT TO ACCELERATE UNEXPECTEDLY IN FORWARD OR REVERSE AND COULD RESULT IN LOSS OF CONTROL, DAMAGE TO THE BOAT OR INJURY TO PASSENGERS. ALWAYS TEST THE NEUTRAL SAFETY SWITCH PERIODICALLY AND CORRECT ANY PROBLEMS BEFORE USING THE BOAT.

4.4 Engine Power Tilt & Trim

All outboard engines are equipped with a tilt and trim feature. On most outboard boats, tilt/trim switches are built into the engine shift and throttle controls that allow the operator to control the position of the outboards from the helm. Typically, a switch or switches on the port control lever grip activates the tilt/trim for all engines simultaneously. Most Yamaha engine controls have three switches for triple or triple engines on the cover that activate each engine tilt/trim individually.

Notice:

Some triple engine controls are equipped with a separate tilt/trim switch panel with a switch for each engine.

Helm Control Systems

The maximum tilt angle is usually preset at the factory. If necessary, the maximum tilt angle can be adjusted by your Everglades or engine dealer by reprogramming the settings using a computer controlled diagnostic system.

Moving the outboards closer to the boat transom is called trimming "in" or "down." Moving the outboards further away from the boat transom is called trimming "out" or "up." In most cases, the boat will run best with the outboards adjusted so the hull will run at a 3 to 5 degree angle to the water. The term "trim" generally refers to the adjustment of the outboards within the first 20° range of travel. This is the range used while operating your boat on plane. The term "tilt" is generally used when referring to adjusting the outboards further up for shallow water operation or trailering.

Some control systems provide a means to set the engine trim angle to automatically adjust according to the engine speed. For information on the proper use and maintenance of the power tilt and trim, please refer to the engine owner's manual.



Yamaha Helm Master Control Engine Trim Switches



CAUTION



THE ENGINE HOSES AND CABLES OR THE TRANSDOM GEL COAT CAN BE DAMAGED BY TILTING THE ENGINES TO THE FULL UP POSITION WITH THE ENGINES TURNED TO THE WRONG POSITION. MOST BOATS REQUIRE THE STEERING WHEEL TO BE TURNED COMPLETELY TO PORT OR STARBOARD BEFORE TILTING THE ENGINES TO THE FULL UP POSITION. YOU SHOULD MONITOR EACH ENGINE AS IT TILTS TO DETERMINE BEST FULL TILT ENGINE POSITION FOR YOUR BOAT.



CAUTION



SOME AUTOPILOTS HAVE ENGINE POSITION SENSORS THAT ARE MOUNTED TO THE HYDRAULIC STEERING CYLINDER. WITH THESE AUTOPILOTS, THE ENGINE POSITION SENSOR BRACKET COULD HIT THE TRANSDOM WHEN THE ENGINES ARE TILTED TO THE FULL UP POSITION AND CAUSE DAMAGE TO THE ENGINE RIGGING, THE AUTOPILOT OR THE TRANSDOM. IF YOU HAVE AN AUTOPILOT INSTALLED ON YOUR BOAT, YOU SHOULD MONITOR THE LOCATION OF THE ENGINE CABLES AND AUTOPILOT BRACKETS AS THE ENGINES ARE TILTED TO DETERMINE THE BEST ENGINE POSITION AND MAXIMUM ENGINE TILT FOR YOUR APPLICATION.



Yamaha Triple Engine Stop Switch & Lanyard
Ignition START/STOP Switches

4.5 Engine Stop Switch

Your boat is equipped with an engine stop switch and lanyard at each helm. When the lanyard is pulled it will engage the switch and shut off the engines. We strongly recommend that the lanyard be attached to the driver whenever the engines are running. If an engine will not start, it could be because the lanyard is not properly inserted into the engine stop switch. Always make sure the lanyard is properly attached to the engine stop switch before attempting to start the engines.

Refer to the engine owner's manual for more information on the engine stop switch.



Triple Engine Stop Switch Lanyard

Helm Control Systems

4.6 Steering System

Triple and Triple Engine Electronic Steering

Triple engine boats are equipped with an electronic steering system that provides precise and responsive steering.

The system is 100% electronic and there are no mechanical connections between the steering wheel and the drives. Each drive unit is turned independently allowing improved tight quarter maneuvering and the convenience of a Joystick control at the helm.

For safety and improved tight quarter maneuvering, the controlling software on most systems senses engine speed and adjusts maximum steering angle and steering wheel resistance to preset limits as the engine speed increases or decreases. The steering angles and steering wheel resistance at specific engine speeds are programmed into the system at the factory and are not adjustable.

The steering on each motor is totally independent with full redundancy built into the system. If the steering fails on one engine, the other units will continue to operate. Should a failure in one steering system occur, the controlling software will sense the failure, limit the engine RPM as a safety precaution and alert the operator.

Each steering control system has emergency procedures that are specific to the steering system and type of failure. It is very important to follow the correct procedure to avoid damage to the engine cowlings if a steering system failure occurs.

Refer to the engine manufacturer owner's manuals for specific information on the operation, maintenance and emergency procedures for the steering system installed in your boat.

Tilt Steering Wheel

The steering wheel can be tilted to five different positions by activating the tilt lock lever located on the bottom of the helm station. When the lever is released, it automatically locks the steering wheel at or close to that angle. Refer to the steering manufacturer owner's manual for specific information on the steering system.



Helm Master Engine Mounted Electronic Steering



Typical Tilt Steering Wheel

Helm Control Systems

4.7 Joystick Controls

A joystick control system is standard equipment on triple engine boats. The joystick can only be used at slow speeds. It is engaged by moving the shift and throttle controls to the neutral position and pressing the Joystick button on the base of the joystick control or the keypad on the main engine controls. Once activated, the boat moves in the direction the joystick is pushed with engine speed increasing the further the stick is pushed, up to preset limits. Turning the knob on the top of the joystick rotates the boat in the direction the knob is turned. Another button on the joystick or engine control key pad raises the preset engine speed for maneuvering in high winds and/or strong tides.

When the joystick is released, it automatically returns to center, the engines shift to neutral, rotate to the straight ahead position, and engine speed is reduced to idle. It is deactivated by pressing the Joystick button at the base of the joystick or control keypad or by moving the shift and throttle control levers.

All engines must be running for the joystick control to maneuver boat properly.

Always refer to the engine manufacturer owner's manuals for specific information on the operation and maintenance for the joystick and steering control systems on your boat.



Yamaha Helm Master Joystick



DANGER



SOME JOYSTICKS AND ELECTRONIC CONTROL SYSTEMS ARE EQUIPPED WITH A FEATURE WHICH USES THE ENGINES TO AUTOMATICALLY HOLD THE BOAT IN POSITION. THIS FEATURE CAN CAUSE SERIOUS INJURY OR DEATH TO PERSONS SWIMMING NEAR THE BOAT OR ATTEMPTING TO BOARD WHEN IT IS ACTIVATED.

WHEN THE POSITION HOLDING FEATURE IS ACTIVATED:
THE PROPELLERS ROTATE AUTOMATICALLY;
PROPELLER ROTATION MAY NOT BE OBVIOUS;
THE BOAT MAY SUDDENLY MOVE IN ANY DIRECTION;
THE PROPELLERS CAN INJURE PEOPLE IN THE WATER ANYWHERE AROUND THE BOAT.

IF YOUR BOAT IS EQUIPPED WITH A POSITION HOLDING FEATURE, THE FOLLOWING PRECAUTIONS APPLY:

ALWAYS ASK THE CAPTAIN BEFORE ENTERING THE WATER.

UNLESS THE CAPTAIN GIVES YOU PERMISSION:
DO NOT GO IN THE WATER; WIND OR WATER CURRENT CAN MOVE SWIMMERS INTO THE PROPELLERS.
DO NOT SIT OR STAND WHERE YOU COULD FALL OVERBOARD; YOU MAY LOSE YOUR BALANCE IF THE BOAT MOVES SUDDENLY.

Helm Control Systems

4.8 Zipwake Trim Tabs

Interceptor blade style trim tabs are mounted to each side of the transom. A control panel with a 3D display provides position monitoring and control of running trim, heel or heading. Running trim (bow up/down) adjustments control the hull planing attitude, while heel (port and starboard up/down) adjustments provide control for the hull listing.

A LED display shows the position of the blades and running trim and heel angles. Control wheels below the display provide manual control of trim and heel settings. The system also operates in automatic mode, which is enabled by pressing the AUTO button.

The trim blades are programmed to automatically retract when the engines are shutdown to keep the actuators clean and set the blades in the retracted position when leaving the dock. Refer to the Zipwake operating manual for more information on the operation, programming and maintenance of the trim system.

When manually setting hull trim, make sure that the blades are fully retracted when you leave the dock. If they are not, use the control wheel to retract the blades.

Always establish the intended heading and cruise speed before adjusting the hull attitude with the trim blades. After stabilizing speed and direction, move the blades to achieve a level side to side running attitude, being careful not to over trim.

After initiating an adjustment, always wait a few seconds for the change in trim angle to take effect. Avoid rotating a wheel while awaiting the trim reaction. By the time the effect is noticeable the trim blade will have moved too far and thus the boat will be in an overcompensated position.

When running at a speed that will result in the boat falling off plane, extending the blades slightly, bow down, will improve the running angle and operating efficiency. Too much bow down blade extension can reduce operating efficiency and cause substantial steering and handling difficulties.

Be extremely careful when operating in a following sea. The effect of trim tabs is amplified under such conditions. Steering and handling difficulties can result from improper trim tab usage, particularly in a following sea. Always retract the blades to the full bow up position in these conditions.



Trim Tab Control Panel

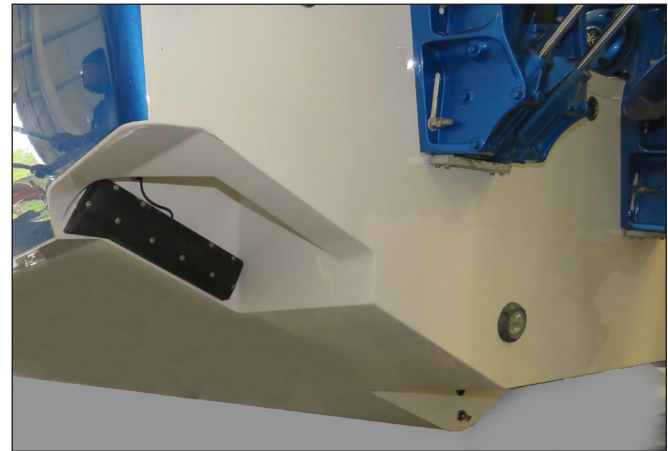

Trim Tab Interceptor on Transom

When running at high speeds be sure that the blades are fully retracted. Only enough trim blade action should be used to compensate for any listing. Trim tabs are extremely sensitive at high speeds. Adjust for this and be prepared to slow down if difficulties arise.



When running into a chop, a slight bow down attitude will improve the ride. Be careful not to over trim. Handling difficulties may result.

4.9 Control Systems Maintenance Control Maintenance

Periodic inspection of the control systems and all connections should be made. Signs of rust, corrosion, wear or other deterioration should immediately be serviced. Generally, periodic lubrication of all moving parts and connections with a light waterproof grease is in order.

Lubrication should be performed as often as necessary to keep the system operating smoothly.

Control system adjustments may become necessary. If adjustments become necessary, see your Everglades dealer.

 **WARNING** 



DO NOT ATTEMPT CONTROL ADJUSTMENTS UNLESS YOU ARE FAMILIAR WITH SERVICING CONTROL SYSTEM PROCEDURES. CONTROL MISADJUSTMENT CAN CAUSE LOSS OF CONTROL AND SEVERE ENGINE OR LOWER UNIT DAMAGE.

Electronic Steering and Control Systems Maintenance

Electronic steering and control systems are supplied by the engine manufacturer. The systems have maintenance requirements that are specific to the engines and control options installed in your boat.

You should refer to the engine and controls systems owner's manuals for information and maintenance on the control and steering system installed in your boat. Their recommendations should be followed exactly.

The engine controls and steering systems are fully electronic and activated by micro processors and controlling software in each drive unit. If adjustment becomes necessary do not attempt to address the problem yourself. You should contact your Everglades or outboard engine dealer for assistance.

 **WARNING** 

IMPROPERLY ADJUSTED ELECTRONIC ENGINE CONTROLS CAN CAUSE LOSS OF CONTROL AND SEVERE ENGINE DAMAGE. IF YOUR CONTROLS ARE NOT OPERATING PROPERLY, DO NOT ATTEMPT CONTROL SYSTEM ADJUSTMENTS YOURSELF. CONTACT YOUR EVERGLADES OR ENGINE DEALER FOR ASSISTANCE AND DO NOT USE THE BOAT UNTIL THE SITUATION IS CORRECTED.

Engine Lubrication

Please refer to the engine owner's manual for maintenance and lubrication instructions for the outboard engines.

Trim Tab Maintenance

The trim blade actuators are electric and require no routine maintenance except to periodically inspect the actuators for marine growth and test the system to ensure that it is operating properly.

Marine growth can interfere with the proper operation of the trim blades. To reduce problems due to marine growth, always fully retract the blades after operating the boat and periodically inspect and clean marine growth from the actuators and blades.

To discourage marine growth on the actuators, antifouling paint can be applied. When applying paint to the an actuator, make sure the blade is fully retracted. Do not paint the blade above the area that is exposed when retracted. Bottom paint could damage the actuator when the blade is retracted. Contact your dealer or Zipwake for information regarding the correct bottom paint for the trim system.

Refer to the Zipwake owner's manual for additional maintenance information, specifications, troubleshooting and operating instructions.

FUEL SYSTEM

5.1 General

The Gasoline fuel system used in Everglades boats sold in the United States is designed to meet or exceed the emission control standards of the Environmental Protection Agency (EPA) and the requirements of the U.S. Coast Guard, the Boating Industry Association and the American Boat and Yacht Council in effect at the time of manufacture.

All gasoline fuel systems have been factory inspected and pressure tested in accordance with regulations in effect at the time of manufacture. This inspection assures that the system is air tight, leak proof and safe. It is the responsibility of the purchaser to maintain it in that condition. Make frequent inspections to assure that no deterioration or loosening of connections is resulting from vibration.

⚠ **DANGER** ⚠

DO NOT LET THE ODOR OF GASOLINE GO UNCHECKED. ANY ODOR OF GASOLINE MUST BE IMMEDIATELY INVESTIGATED AND STEPS TAKEN TO PROTECT THE BOAT AND ITS OCCUPANTS UNTIL THE PROBLEM IS CORRECTED. IF THE ODOR OF GASOLINE IS NOTED, SHUT OFF ALL ENGINES AND ELECTRICAL EQUIPMENT. INVESTIGATE AND CORRECT THE SITUATION IMMEDIATELY. HAVE ALL PASSENGERS PUT ON PERSONAL FLOTATION DEVICES AND KEEP A FIRE EXTINGUISHER READY UNTIL THE SITUATION IS RESOLVED.

Fuel Withdrawal Tubes

The fuel withdrawal tubes are positioned in the fuel tank to achieve optimum fuel usage, fuel line routing, etc. At certain speeds and hull trim angles, the fuel supply at the withdrawal tank location can increase or decrease accordingly. Be extremely careful when attempting to operate the boat when low on fuel. Though some fuel may be in the tank, the relative trim angle of the boat may cause the fuel to flow away from the withdrawals.

Fuel Gauge

Indicates the amount of fuel in the tank. Due to the mechanical nature of the fuel sender, variations in readings during various speeds of operation may occur. This system is merely a relative indication of the available fuel supply and not a calibrated instrument.



Typical Fuel Fill

Fuel Fill

The fuel tank is vented through the fill fitting and cap. The system is equipped with a "keyless" fuel cap located on the port side gunnel that is marked "GAS." The fuel fill cap is designed to seal out water and allow the fuel tank to vent to the atmosphere when the cap is closed.

The fuel fill is opened by pressing the release button on the side of the cap. After fueling, make sure to close and latch the cap. Be sure to use the proper type and grade of fuel. Refer to the engine owner's manual for additional information.

Fuel Tank Vent

Your boat is equipped with a fuel tank vent system incorporated into the fuel fill. The fuel fill cap is designed to seal out water and allow the fuel tank to vent to the atmosphere when the cap is closed.

While the tank is being filled, air displaced by the fuel escapes through the vent and fuel fill. When the tank is full, special valves incorporated in the vent and fill hoses close and activate the automatic shutoff valve on the marina fuel pump nozzle to prevent the tank from being overfilled and/or fuel from being ejected from the fuel fill/vent fitting. You should never attempt to "top off" the tank after the nozzle shutoff has activated. The shutoff valves will not allow additional fuel to be added after they close and could be damaged by attempts to force additional fuel into the tank.





Typical Yamaha Engine Fuel Filters & Primer Bulbs

After fueling, close and latch the fill cap. Then wash spilled fuel from the areas around the fuel fill if necessary. Residual fuel left on the deck and hull sides can be dangerous and will yellow the fiberglass or damage the striping.

5.2 Outboard Engine Fuel System

The gasoline fuel system has one fuel tank that fills from the port gunnel. Each engine is supplied by an independent withdrawal tube and fuel line. Triple engine fuel tanks have three withdrawal tubes and fuel lines. There is an on/off valve for each supply line located on the fuel tank near each withdrawal tube. The valves provide a means to turn off the fuel supply to service the fuel system.

Fuel withdrawal lines are equipped with anti-siphon valves where the lines attach to the fuel tanks. These valves prevent gasoline from siphoning out of the fuel tank should a line rupture.

	WARNING	
<p>DO NOT REMOVE THE ANTI-SIPHON VALVES FROM THE SYSTEM. SHOULD AN ANTI-SIPHON VALVE BECOME CLOGGED, CLEAN AND REINSTALL OR REPLACE. IF A FUEL LINE SHOULD LEAK, ANTI-SIPHON VALVES PREVENT A SUBSTANTIAL AMOUNT OF FUEL FROM FLOWING INTO THE BILGE. ANTI-SIPHON VALVES ARE REQUIRED TO BE INSTALLED IN ALL BOATS EQUIPPED WITH GASOLINE ENGINES BY THE U.S. COAST GUARD</p>		

Engine Fuel Filters

On most engine installations, the fuel filter for each engine is installed in the aft systems compartment. The filters are accessed through the hatch at the rear of the cockpit sole. The filters are the water separator type and should be serviced frequently to assure an adequate supply of clean, dry fuel to the engines. It is recommended that the filters be inspected periodically and the elements changed as needed.

Fuel System

There is a primer bulb in each fuel line located near the fuel filters that is used to prime the fuel system after service or as required. See Fuel System Maintenance and the engine owner's manual for additional information regarding fuel filters and the outboard engine fuel system.

Notice:

Clean fuel is especially important in fuel injected engines. The engine manufacturer's recommendations for fuel filter maintenance must be followed exactly.

Notice:

The procedure to prime the fuel system on outboard engines is specific to the type and model of engines on your boat. You should refer to engine manufacturer owner's manual for the priming procedure for your engines.



Diesel Fuel Filter

5.3 Diesel Generator Fuel System

The diesel fuel system for the generator is completely separate from the gasoline system. The diesel fuel tank is located in the stern bilge below the cockpit and is filled from a fuel fill deck plate on the gunnel labeled "Diesel." The fuel system is not equipped with an anti-siphon valve and there is a fuel return line from the engine that returns unused fuel to the fuel tank.

Proper diesel engine operation requires a good supply of clean, dry diesel fuel. Improper marina fuel storage techniques, limited boat usage, etc. can cause the fuel to become contaminated. Periodically, it may be necessary to pump accumulating water and contaminated fuel from the bottom of the fuel tank. If the generator fuel system on your boat becomes contaminated, contact your dealer or Everglades Customer Service for assistance.

Algae can grow in the accumulated water in diesel fuel tanks. This condition is most prevalent in warm climates. Periodically adding a high quality diesel fuel additive containing an algicide may be required to control algae in your boating area. You should contact your dealer or the generator manufacturer for additional information regarding fuels and additives.

Notice:

Do not allow the generator to sit unused for an extended period with the fuel tank less than full. Changes in temperature and weather conditions can cause condensation in diesel fuel tanks that are less than 3/4 full.

Diesel Fuel Filter

A water separator type fuel filter is mounted near the generator in the aft systems compartment. Another filter is typically installed on the generator inside the sound shield. Replace the filter cartridges as recommended by the generator manufacturer or as needed.

It is particularly important to monitor the condition of the fuel filters frequently because diesel engines circulate much more fuel than they consume. Because of the volume of fuel that flows through the filters, they typically must be changed at least twice a season or more frequently depending on the quality of the fuel and the hours run. Follow the generator manufacturer's instructions for replacing the filters.

Notice:

Diesel fuel systems may need to be primed after servicing. Refer to the generator owner's manual for information on priming the fuel system.

	WARNING	
DO NOT DRAIN ANY FUEL IN THE BILGE. THIS COULD LEAD TO A FIRE OR EXPLOSION.		
CHECK ALL FUEL LINE FITTINGS FOR LEAKS BEFORE AND AFTER STARTING THE ENGINES FOLLOWING ANY FUEL SYSTEM SERVICE.		

Fuel System

5.4 Fueling Instructions



WARNING



FUEL IS VERY FLAMMABLE. BE CAREFUL WHEN FILLING THE FUEL TANK. NO SMOKING. NEVER FILL THE TANK WHILE AN ENGINE IS RUNNING. FILL THE FUEL TANK IN AN OPEN AREA. DO NOT FILL THE TANK NEAR OPEN FLAMES.



CAUTION



TO PREVENT DAMAGE TO THE FUEL SYSTEM, USE ONLY A GOOD GRADE OF GASOLINE FOR GASOLINE ENGINES. DO NOT USE FUEL THAT CONTAINS HARSH ADDITIVES OR IS AN ALCOHOL BLEND OF HIGHER CONCENTRATION THAN RECOMMENDED BY THE ENGINE MANUFACTURER. ANY DAMAGE DONE TO THE FUEL SYSTEM THAT IS THE RESULT OF USE OF AN ALCOHOL BLEND IS NOT COVERED BY THE EVERGLADES WARRANTY. REFER TO THE ENGINE MANUFACTURER OWNER'S MANUAL REGARDING FUEL REQUIREMENTS FOR YOUR ENGINES.



WARNING



DO NOT CONFUSE THE FUEL FILL DECK PLATE WITH THE WATER OR WASTE PUMP OUT DECK PLATE. THESE PLATES ARE LABELED ACCORDINGLY. IF GASOLINE OR DIESEL FUEL IS ACCIDENTALLY PUMPED INTO THE WATER OR WASTE TANK, DO NOT ATTEMPT TO PUMP IT OUT YOURSELF. WATER AND WASTE PUMPS ARE NOT DESIGNED TO PUMP FUEL AND A FIRE OR EXPLOSION COULD RESULT. CONTACT YOUR DEALER OR THE EVERGLADES CUSTOMER SERVICE DEPARTMENT FOR ASSISTANCE IN HAVING THE FUEL PROFESSIONALLY REMOVED.

Preparing The Boat For Fueling

Use the following procedure to prepare the boat for fueling at a marina fuel pump:

- Make sure the boat is securely moored and all engines are off.
- Make sure all switches are in the OFF position.
- Make sure all passengers leave the boat.
- Close all doors and hatches.
- If the boat is equipped with a generator, make sure the blowers are off to prevent fuel fumes from entering the equipment compartment.



WARNING



GASOLINE FUEL VAPORS THAT ACCUMULATE IN THE BILGE, AFT SYSTEMS COMPARTMENT OR CABIN WHILE FUELING CAN EXPLODE!! FUEL VAPORS ARE HEAVIER THAN AIR AND CAN ACCUMULATE IF THEY ARE CARRIED BY THE WIND INTO THE BILGE OR CABIN THROUGH OPEN DOORS, HATCHES OR VENTS. VAPORS CAN ALSO BE DRAWN INTO THE AFT SYSTEMS COMPARTMENT BY THE BLOWERS. ALWAYS TURN BILGE BLOWERS OFF AND CLOSE DOORS AND HATCHES BEFORE FUELING.

- Estimate how much fuel is needed and avoid overfilling the fuel tank..

Fueling The Boat

In order to comply with U.S. EPA emission regulations, boats sold in the United States are equipped with special fuel systems that reduce the flow of fuel vapors from the fuel system to the atmosphere when fueling operations are complete.

These fuel systems meet U.S. EPA emission standards and are designed to maintain a specific air space at the top of the fuel tank that provides proper tank ventilation and protection for emission control components. Special valves in the fuel tank vent and fill systems and a shutoff valve in marina fuel pump nozzles are designed to automatically stop the fuel flow when the tank is full and maintain this air space.

Notice:

When the fuel tank is full, the shutoff valve in the marina fuel pump nozzle will activate and automatically shut off the flow, indicating that the tank is filled to the maximum level. You should stop filling the tank at this point and never attempt to "top off" the tank. Attempting to "top off" the tank could damage fuel level control valves.



WARNING



STATIC ELECTRICITY GENERATED BY FLOWING FUEL CAN CAUSE A FIRE OR EXPLOSION. TO PREVENT STATIC SPARKS WHEN FILLING THE TANK, MAKE SURE THE NOZZLE IS ALWAYS IN CONTACT WITH THE FUEL FILL OPENING

Fuel System

To fill the fuel tank, follow this procedure:

- The fuel cap is hinged and does not require a key. Press the release button on the side of the cap and swing it open for fueling.
- Make sure the nozzle is equipped with an automatic shutoff valve. Then put the nozzle in the fuel fill opening and make sure it stays in contact with the fuel fill fitting during the entire fueling operation.
- Fill the tank until the shutoff valve in the pump nozzle clicks and automatically stops the fuel flow.
- Remove the nozzle and close the cap.

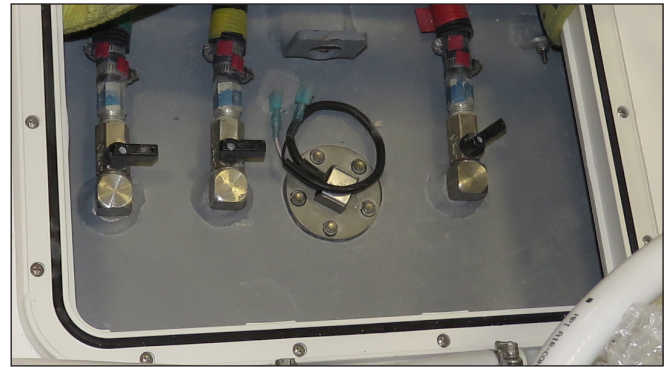

Fuel Gauge Sender & Withdrawal Valves



WARNING



SPILLED FUEL CAN CAUSE A FIRE OR AN EXPLOSION. MAKE SURE YOU DO NOT SPILL ANY FUEL. IF A SMALL AMOUNT OF FUEL IS SPILLED ON THE FIBERGLASS, USE A CLOTH TO REMOVE THE FUEL AND PROPERLY DISPOSE OF THE CONTAMINATED CLOTH. IF FUEL IS SPILLED ON THE WATER, EXERCISE EXTREME CAUTION. FUEL FLOATS ON THE SURFACE OF THE WATER AND CAN IGNITE. IF FUEL IS SPILLED INTO THE WATER, IMMEDIATELY EVACUATE THE AREA AND NOTIFY THE MARINA AND THE PROPER OFFICIALS.



DANGER



GASOLINE FUEL VAPORS THAT ACCUMULATE IN THE CABIN OR AFT SYSTEMS COMPARTMENT WHILE FUELING CAN EXPLODE!! TO REDUCE THE RISK OF A FIRE AND/OR EXPLOSION WHEN OPERATING THE GENERATOR AFTER FILLING THE FUEL SYSTEM, ALWAYS RUN THE BLOWERS FOR AT LEAST FOUR (4) MINUTES AND OPEN ALL HATCHES, WINDOWS AND DOORS TO COMPLETELY VENTILATE THE BOAT BEFORE STARTING THE GENERATOR.

Preparing The Boat For Operation

Use the following procedure to prepare the boat for operation when fueling operations are complete:

- Open all hatches, windows and doors.
- Check the fuel compartment and below the deck for fuel odors. If you smell fuel, do not start the engines.
- If your boat is equipped with a generator, run the blower for at least four minutes to completely ventilate the aft systems compartment before starting the generator.



WARNING



TO REDUCE THE RISK OF A FIRE AND/OR EXPLOSION, DO NOT START THE ENGINES WHEN FUEL FUMES ARE PRESENT. FUEL FUMES ARE DANGEROUS AND HARMFUL TO YOUR HEALTH.

MAKE SURE ALL GASOLINE ODORS ARE INVESTIGATED IMMEDIATELY.

5.5 Fuel System Maintenance

Periodically inspect all primer bulbs, connections, clamps and hoses for leakage, damage or deterioration. Replace as necessary. Spray the valves, tank fuel gauge sender and ground connections with a metal protector.

Frequently inspect and lubricate the fuel fill cap seal with Teflon or silicone grease. The seal prevents water from entering the fuel system through the fuel fill cap and it should be immediately replaced if there is any sign of damage or deterioration.

Contaminated fuel may cause serious damage to your engine. Fuel filters must be checked for corrosion and deterioration frequently. Fuel filters must be changed at least once a season or more frequently depending on the type of engine and the quality of the fuel. Refer to the engine or fuel filter manufacturer's instructions for information on servicing and replacing the fuel filter.

Fuel System

The age of gasoline can effect engine performance. Chemical changes occur as the gasoline ages that can cause deposits and varnish in the fuel system as well as reduce the octane rating of the fuel. Severely degraded fuel can damage the engine and boat fuel tank and lines. Therefore, if your boat is not being run enough to require at least one full tank of fresh fuel a month, a fuel stabilizer should be added to the gasoline to protect the fuel from degradation. Your dealer or the engine manufacturer can provide additional information on fuel degradation and fuel stabilizers recommended for your engine.

In many states, most gasoline is blended with ethanol alcohol. Ethanol is a strong solvent and can absorb water during periods of storage. You should refer to the engine operating manual for information regarding alcohol blended fuels and how it affects the operation of your marine engine.

Diesel Generator Fuel System

Algae can grow in the accumulated water in diesel fuel tanks. This condition is most prevalent in warm climates. Periodically adding a high quality diesel fuel additive containing an algaecide may be required to control algae in your boating area. Since algae also can grow in accumulated water in the fuel filters, it is important to run the generator for at least 30 minutes after the algaecide has been added so it will be circulated throughout the fuel system. This is even more important during periods of storage or if the generator is not used enough to require refueling at least once a month.

Severe algae in a diesel fuel system can be extremely difficult and expensive to clean. You

should be diligent in monitoring the fuel system by changing the fuel filters as recommended and being alert for signs of algae in fuel that is drained from the filter. Most algae appears as black, carpet like, fibers suspended in fuel and water drained from the filter. Severe cases of algae will produce a black jelly like substance that quickly clogs the filter and starves the engine for fuel.



WARNING



DO NOT DRAIN ANY FUEL INTO THE BILGE WHEN SERVICING THE FUEL SYSTEM. THIS COULD LEAD TO A FIRE OR EXPLOSION.

AFTER THE FILTER ELEMENTS HAVE BEEN CHANGED, PRIME THE FUEL SYSTEM AND CHECK ALL FITTINGS FOR LEAKS BEFORE AND AFTER STARTING THE ENGINES.

BEFORE STARTING THE ENGINES, ALWAYS OPEN ALL HATCHES, WINDOWS AND DOORS TO COMPLETELY VENTILATE THE BOAT AFTER SERVICING THE FUEL SYSTEM.



WARNING



TO REDUCE THE POSSIBILITY OF A FIRE OR EXPLOSION, MAKE SURE ALL ELECTRICAL SWITCHES ARE IN THE OFF POSITION BEFORE SERVICING THE FUEL SYSTEM.



DANGER



AVOID SERIOUS INJURY OR DEATH FROM FIRE OR EXPLOSION RESULTING FROM LEAKING FUEL, INSPECT SYSTEM FOR LEAKS AT LEAST ONCE A YEAR.

ELECTRICAL SYSTEM

6.1 General

Your Everglades is equipped with 120 volt AC and 12 volt DC electrical systems. The AC system can draw current from one of two sources, either shore power outlets at dockside or the generator. The DC system draws current from onboard batteries.

Your boat and engine charging system is designed for 12 volt marine batteries. All wires in the electrical systems are color coded to make identifying circuits easier. Wiring schematics have been included with this manual.

6.2 DC System Overview

The 12 volt system is a fairly standard marine system. There are seven batteries, one for each engine and four for the house, generator and electronics. The House batteries are connected to the engine auxiliary charging circuits.

The batteries are located in compartments in the cabin below the V-berth cushions. Triple engine battery systems are controlled by four battery switches, one for each engine and one for the house 12 volt accessories, generator and electronics. The batteries are charged by the engines or the battery chargers when connected to shore power or when the generator is operating.

Most 12 volt power is distributed to the 12 volt accessories through individual circuit breakers and fuses located in panels near the batteries, at the helm and in the hardtop. All circuit breakers or fuses are labeled with the name of the circuit they protect. Main circuit breakers near the batteries protect the primary circuits for the DC main, electronics, windlass and other accessory circuits. Additional fuses in panels near the main circuit breakers protect continuous power circuits for the stereo memory, automatic switches for bilge pumps and high water alarm, shower sump automatic switch, CO monitor and the helm battery switches. 12 volt accessories are operated by switches in the helm switch panels, digital switches in the Garmin displays, cabin switch panels or optional upper helm switch panel. Most



Battery Switches, Main Circuit Breakers
& Continuous Power Fuse Panels

accessory circuits are protected by circuit breakers in the digital switch control modules.

Main breakers or fuses located on each engine protect the ignition systems and gauge panel display. Other main, heavy duty fuses or circuit breakers in the aft systems compartment protect the primary engine control circuits on boats equipped with triple Yamaha engines and Helm Master controls.

Yamaha engine electrical circuits are protected by fuses located in a fuse panel on the side of the engine. The engine fuse panels are equipped with a spare fuse for each circuit. Always replace fuses used with the fuse specified by the engine manufacturer. Refer to the engine owner's manual for more information on the fuses, fuse panels or circuit breakers on your engines.

CAUTION

PROPER FUSE OR BREAKER PROTECTION MUST BE PROVIDED FOR ALL 12 VOLT EQUIPMENT ADDED. DO NOT OVERLOAD THE ACCESSORY CIRCUIT BREAKERS OR OTHER CIRCUITRY THROUGH ADDITIONAL 12 VOLT EQUIPMENT.

Electrical System



Engine Battery switches & Battery Parallel Switch, Fuse Panels for Remote Battery & Parallel Switches Located Behind the Starboard Cabin V-Berth Backrest Cushion

6.3 Batteries & Battery Switches

The DC electrical system on your boat is designed for 12 volt marine batteries only. The batteries are mounted in a compartment below the cabin V-berth that is vented. The engine charging system and/or the battery chargers may not be able to recharge gel cell batteries properly which could cause unusually short battery life, engine starting problems and damage to the DC charging systems. Wet cell batteries will emit hydrogen gas during recharging which will damage components in the battery compartment and create an explosion hazard in the cabin.

You also should not mix the size or brand of batteries. Always consult your dealer before changing the type of batteries in your boat.



Engine Start Batteries Below Starboard V-Berth Cushion

⚠ DANGER ⚠

NEVER USE WET CELL BATTERIES. WET CELL BATTERIES EMIT DANGEROUS HYDROGEN GAS WHILE BEING CHARGED. HYDROGEN GAS CAN EXPLODE IF A FLAME OR SPARK IGNITES THE GAS, WHICH WILL RESULT IN SEVERE INJURY OR DEATH.

THE BATTERY COMPARTMENT IS NOT DESIGNED TO VENTILATE DANGEROUS HYDROGEN GAS TO THE ATMOSPHERE WHICH COULD ALLOW THE GAS TO ACCUMULATE TO DANGEROUS LEVELS. ABSORBED GLASS MAT (AGM) BATTERIES DO NOT EMIT HYDROGEN GAS AS THEY RECHARGE. USE ONLY ABSORBED GLASS MAT (AGM) BATTERIES IN THIS BOAT.

The engine starting batteries should be of the size and capacity recommended by the manufacturer of your engines. These specifications should be considered the minimum size battery required. Consider increasing the capacity of the batteries if you will be trolling, drift fishing or have extensive electronics on board. Larger batteries will give you additional capacity to operate the baitwells, DC accessories and electronics at low speed when the charging system output from the engines is minimal. Refer to the engine owner's manual for additional information on the battery requirements for your engines.

Electrical System



House Battery Switch, SeaKeeper Switch, Continuous Power Fuse Panels & Main Circuit Breakers Located Behind the Port Cabin V-Berth Backrest Cushion

Batteries and Battery Switches

Triple engine boats are equipped with 7 batteries. One battery for each engine and four batteries wired in parallel for the house, generator, SeaKeeper and electronics circuits. The batteries are located in compartments below the port and starboard V-berth cushions in the cabin.

There is a remote activated battery switch for each engine, the house circuits, remote activated emergency parallel switch and the SeaKeeper located in the cabin behind the port & starboard V-berth backrest cushions. The remote battery and emergency parallel switches are activated by special switches in the helm battery switch panel. Each battery switch has a manual override that can activate (enable) or deactivate (disable) the switch if the remote switch or relay fails. The manual override is a yellow knob on each switch that can be pressed to manually activate the switch or rotated to reactivate remote activation of the switch or to lockout the switch in the OFF position when servicing the electrical system. The normal operating position for each switch is the "Enabled" Position. Refer to the instructions printed on each switch and/or the battery switch operation manual for additional information on the remote activated switches.

The engine main and auxiliary charging systems control the charging of the engine and house batteries whenever the engines are operating. The engine batteries can be temporarily connected in parallel by the emergency parallel switch at the helm to pro-



House & Optional SeaKeeper Batteries Below Port V-Berth Cushion



Helm Battery Switch Panel



Battery Switch Panel at Helm

vide additional starting current for the engines. The batteries are also charged by the battery chargers when plugged into shore power or when running the generator.

The engine charging systems manage the charging current for the 12 volt system whenever the engines are running. The systems automatically sense the condition of each battery and direct available current to the batteries that require charging.

When the engines are started, the engine alternators start to recharge the batteries. The charging circuits sense the charge and it is split between the batteries, with the lowest batteries receiving the most charge. When the engines are turned off, charging stops and the sensing circuits disconnect the batteries from the charging circuits, thereby automatically isolating the batteries from one another.

When in port or at anchor, the engine and SeaKeeper battery switches should be off. Only the battery switch that activates the House circuit and generator should be on. This will keep the engine starting batteries in reserve for starting the engines.

Notice:

Current is supplied to the automatic switches for the bilge pumps when the batteries are connected and the battery switches are off.

Notice:

The manual overrides on the battery switches completely bypass the remotely activated switches when the switches are manually activated. The circuits cannot be turned off using the remote battery switches on the helm panel if the battery switches have been activated by the manual switches.

6.4 Remote Battery Switch Panel

Each battery switch and the emergency parallel relay are controlled by a switch in the battery switch panel located in the lockable fold out helm switch panel on the port side of the helm. A red light in each switch will illuminate to indicate that the battery the switch it controls is now ON. When the battery switch is turned off, the red light may not turn off immediately or will slowly fade out if there are no loads present on the system. This is normal as the capacitors in the system drain.

Engine Port

Remotely activates the Port Engine battery switch. Slide the label down and press the top of the switch to activate the battery switch. Slide the label up and press the bottom of the switch to turn the battery switch off.

Engine Center

Remotely activates the Center Engine battery switch. Slide the label down and press the top of the switch to activate the battery switch. Slide the label up and press the bottom of the switch to turn the battery switch off.

Engine Starboard

Remotely activates the Starboard Engine battery switch. Slide the label down and press the top of the switch to activate the battery switch. Slide the label up and press the bottom of the switch to turn the battery switch off.

House

Remotely activates the House battery switch. Slide the label down and press the top of the switch to activate the battery switch. Slide the label up and press the bottom of the switch to turn the battery switch off.

SeaKeeper

Remotely activates the Seakeeper battery switch. Slide the label down and press the top of the switch to activate the battery switch. Slide the label up and press the bottom of the switch to turn the battery switch off.

Battery Parallel

A momentary switch that activates the circuit that connects the engine starting batteries in parallel for extra battery power while starting the engines. When the switch is pressed, relays are engaged that connect the engine starting batteries, when the switch is released, the relays are deactivated and the batteries are isolated.

Notice:

The remote battery switch panel is always supplied power whenever the house battery bank is connected.

6.5 Ignition Switch Panels

Ignition switch panels are unique to each engine manufacturer and the engine control options selected. The information in this section provides a general overview of the most common triple ignition systems for Yamaha outboard engines.

Your dealer will provide you with the proper starting procedure for your boat at the time of delivery. Additional information for the ignition switch system installed in your boat is located in the engine and control system operating manuals included in your information packet.

Yamaha Command Link Plus® Ignition

Some Everglades boats equipped with triple Yamaha engines are equipped with Command Link Plus® ignition panels that offer advanced technology and durability. This is a “key” activated ignition panel which energizes the ignition system of multiple outboards with only one key.

The START/STOP panel is used in conjunction with the ignition key panel and features lights which indicate when the engines are running and a START/STOP button for each engine. This system greatly simplifies the starting and stopping process of your engines while providing the simplicity and security of a keyed ignition. For convenience and protection, engines can not be restarted while running.

Starting and stopping procedure

Make sure the engines are shutdown with the shift levers in the neutral position and your hand is on the control levers. Turn the ignition key to the ON position to activate the ignition and START/STOP buttons for the engines. Press and release the START/STOP button for the port engine. It is not necessary to hold the button, just press it once and release it. The computer will automatically check all engine systems and start the engine. Once the engine stabilizes, repeat the starting procedure for the other engines. Stop the engines by pressing the START/STOP buttons again. Then turn the key switch to OFF and remove the key to deactivate the START/STOP panel and secure the engines.



Typical Yamaha Helm Master Triple Engine
Radio Frequency ID Key Activated START/STOP & Ignition Switch Panels

Helm Master Ignition

Some triple engine boats are equipped with the Helm Master ignition panel that offers the latest technology and security. This is a "keyless" electronic panel which energizes the ignition system of multiple outboards with only one Radio Frequency ID key by touching the panel with the electronic key. The panel features lights which indicate when the engines are running and a START/STOP button for each engine. For convenience and protection, engines can not be restarted while running.

Starting and stopping procedure

Make sure the engines are shutdown with the shift levers in the neutral position and your hand is on the control levers. Touch the panel with the elec-

tronic key to unlock and activate the panel. The panel will beep twice to indicate it is unlocked and the buttons are active. Once the panel is activated, press the IGNITION button, then the START/STOP button for the port engine. It is not necessary to hold the button, just press it once and release it. The computer will automatically check all engine systems and start the engine. Once the engine stabilizes, repeat the starting procedure for the other engines. Stop the engines by pressing the START/STOP buttons again. Touch the panel with the electronic key to deactivate and lock the panel. The panel will beep once to indicate that it is locked and the engines and START/STOP buttons are deactivated.



Port Helm Accessory Switch Panel & Battery Switches
(Located in a lockable compartment on the port side of the helm)

6.6 12 Volt Helm Accessory Switch Panels

Digital Touch Switch System

Your boat is equipped with a digital switching system that provides reduced complexity and increased switching options for the lights and accessories the switches control. The system consists of control output modules, digital switch panels and touch screen switches in the helm electronics display panels.

Each circuit is protected by individual circuit breakers built into each control output module. The control output modules are where the switching of input and output current load to the selected accessories takes place. Controllers in each module recognize low voltage, digital signals from the switches and activate the correct programmed combination of circuits for each switch function (i.e. the navigation lights switch actually forces the forward navigation lights and the anchor light to be turned on at the same time).

Interior or cockpit light switches may be programmed to activate different colors for multicolored LED lights activated by the switches as well as their ON/OFF

status. All switches in the push button switch panels are a “press to activate” and “press to deactivate” design. LED lights in each switch indicate the circuit is activated.

This section provides a general description of the accessories typically activated by the digital switch panels. Switch programming is unique to each boat, depending on optional equipment installed at the factory or by your dealer and display preferences chosen at the time of manufacture. Consequently, switch programming on your boat may be different.

Refer to the digital Control System section in this chapter and the Garmin Switch system operation manual for additional information on the digital switching system. Your dealer will also provide you with hands-on instructions at the time of delivery.

NOTICE:
THE PORT HELM ACCESSORY SWITCH PANEL AND REMOTE BATTERY SWITCHES ARE LOCATED IN A LOCKABLE FOLDOUT COMPARTMENT ON THE PORT SIDE OF THE HELM.



Helm Switch Panel on Starboard Side of Steering Wheel

Port Foldout Helm Switch Panel

The following is a description of the accessories controlled by the Port helm accessory switch panel:

Windshield Up/Windshield Down

Two momentary switches that activate the hydraulic rams that raise and lower the windshield to provide ventilation for the helm area and/or improve visibility. Press and hold the DOWN switch to lower the windshield. Press and hold the UP switch to raise the windshield. The switches return to the OFF position when released.

Fresh Water

Activates the pump that supplies water pressure for the fresh water system. The pump is the pressure demand type. A pressure switch automatically controls the water pump when the system is activated and properly primed.

Aft Bilge

Manually activates aft bilge pump #1 located in the aft systems compartment bilge near the transom. The pump moves water out a thru-hull fitting in the hull. The pump is also activated by

an automatic switch whenever the batteries are connected. This pump will run as needed whenever water in the bilge accumulates high enough to be activated by the automatic switch and turn off when the water is removed.

Aft Bilge

Manually activates the aft emergency bilge pump # 2 located behind the aft bilge pump in the aft systems compartment bilge near the transom. The pump moves water out a thru-hull fitting in the hull. The pump is also activated by an automatic switch whenever the batteries are connected. This pump will run as needed whenever water in the bilge accumulates high enough to be activated by the automatic switch and turn off when the water is removed.

Notice:

The bilge pumps will start automatically when there is sufficient water in the bilge to activate the float switch. Each automatic switch is protected by a labeled fuse located near the battery switches and are always supplied current when the batteries are connected.

Electrical System

Shade In/Shade Out (Optional)

Two momentary switches that control the retractable sunshade integrated into the rear of the hardtop. Press the SHADE EXTEND switch to extend the sunshade. Press the switch again to stop the sunshade in the current position.

Press the SHADE RETRACT switch to retract the sunshade. Press the switch again to stop the sunshade in the current position.

A limit switch in the electric actuator that extends and retracts the sunshade will automatically stop the actuator when the sunshade reaches the fully extended or retracted positions.

Forward Spreader

Activates the overhead light at the front of the hardtop that illuminates the forward cockpit.

Aft Spreader

Activates the overhead light at the rear of the hardtop that illuminates the aft cockpit.

Port Spreader

Activates the overhead light on the port side of the hardtop that illuminates the port cockpit.

Starboard Spreader

Activates the overhead light on the starboard side of the hardtop that illuminates the starboard cockpit.

Forward Light Bars

Activates the overhead lights at the front of the hardtop that illuminate the area forward of the bow.

Underwater Lights

Activates the LED underwater lights in stern below the water line. Press the switch once for blue lights, press the switch again for white lights. Press the switch again to turn the lights off.

Windlass Up/Windlass Down

Two momentary switches that control the windlass, which is mounted to the deck forward of the rope locker. Press and hold the WINDLASS DOWN switch to pay the anchor line out. Press and hold the WINDLASS UP switch to pull the anchor line in. The switches return to the OFF position when released.

Starboard Helm Panel Switches

The following is a description of the accessories controlled by the helm accessory switch panel located below the starboard side of the steering wheel:

Horn

A momentary switch that activates the boat air horn located on the hardtop.

Windshield Wiper

Activates the windshield wiper.

Windshield Washer

A momentary switch that activates the solenoid that sprays water on the windshield washer from the fresh water system.

Notice:

The fresh water system must be activated for the windshield washers to work.

Helm Lights

Activates the red overhead map lights above the helm.

Notice:

Red lights have less effect on night vision and should be selected if you need to illuminate the helm area while navigating at night.

Hardtop Lights

Activates the lights in the hard top above the helm and mezzanine seats.

Switch Dimming

Adjusts the intensity of the switch panel back lighting. Press and hold the switch to increase brightness. Press and hold the switch again to decrease brightness.



Typical Switches in the Helm Switch Touch Screen Display

Typical Helm Electronics Display Panel Switches

Accessory switches are integrated into the electronic display panels at the helm. Switches are organized in categories that are displayed on the menu on the starboard side of the screen.

The switches are typically activated by touching one side of the switch icon to activate the accessory and pressing the other side of the switch to turn it off. LED lights in each switch icon illuminate to indicate the circuit is activated.

Notice:

Some switches in the helm switch panels may be duplicated in the electronics display panel for convenience. Switches displayed may vary depending on options selected and factory programming. Your boat may be equipped with additional switches not mentioned.

The following is a description of accessory switches typically controlled by touch screen switches in the electronics display panel:

Docking Lights

Activates the lights in the hull on each side of the bow that illuminate the area in front of the boat for better visibility when docking at night.

Helm Light

Activates the red overhead map lights above the helm.

Nav Lights Underway

Activates the navigation lights.

Nav Lights Anchor

Activates the anchor light.

Underwater Lights

Activates the LED underwater lights in the stern below the waterline.

Fresh H2O Pump

Activates the pump that supplies water pressure for the fresh water system. The pump is the pressure demand type. A pressure switch automatically controls the water pump when the system is activated and properly primed.



Typical Switches in the Lights Switch Touch Screen Display

Raw H2O Pump

Activates the raw water washdown pump that supplies the washdown hose in the cockpit. The pump is the pressure demand type. A pressure switch automatically controls the water pump when the system is activated and properly primed.

Aft Bilge 1

Manually activates the aft bilge pump located in the aft systems compartment bilge near the transom. The pump moves water out a thru-hull fitting in the hull. The pump is also activated by an automatic switch whenever the batteries are connected. This pump will run as needed whenever water in the bilge accumulates high enough to be activated by the automatic switch and turn off when the water is removed.

Aft Bilge 2

Manually activates the aft emergency bilge pump located behind the aft bilge pump in the aft systems compartment bilge near the transom. The pump moves water out a thru-hull fitting in the hull. The pump is also activated by an automatic

switch whenever the batteries are connected. This pump will run as needed whenever water in the bilge accumulates high enough to be activated by the automatic switch and turn off when the water is removed.

Notice:

The bilge pumps will start automatically when there is sufficient water in the bilge to activate the float switch. Each automatic switch is protected by a labeled fuse located near the battery switches and are always supplied current when the batteries are connected.

Windlass Up/Windlass Down

Two momentary switches that control the windlass, which is mounted to the deck forward of the rope locker. Touch and hold the WINDLASS DOWN switch to pay the anchor line out. Touch and hold the WINDLASS UP switch to pull the anchor line in. The switches return to the OFF position when released.

Electrical System

Wiper HI/INT/LOW

Activates the windshield wiper and selects wiper speed and mode.

Intermittent Speed

Control time between wipes when wiper intermittent mode is selected.

FRT Wind UP/DN

Two momentary switches that activate the hydraulic rams that raise and lower the windshield to provide ventilation for the helm area and/or improve visibility. Touch and hold the DOWN switch to lower the windshield. Touch and hold the UP switch to raise the windshield. The switches return to the OFF position when released.

Light Bar

Activates the overhead lights at the front of the hardtop that illuminate the area forward of the bow.

Wiper - One Swipe

Touch to activate the wiper for one swipe.

Wiper - Wash

A momentary switch that activates the solenoid that sprays water on the windshield washer from the fresh water system.

Notice:

The fresh water system must be activated for the windshield washers to work.

Hardtop Lights

Activates the lights in the hard top above the Helm and mezzanine seats.

Ctsy Lights

Activates the lights in the cockpit below the gunnels that illuminate the cockpit sole.

FWD Light Bar

Activates the overhead lights at the front of the hardtop that illuminate the area forward of the bow.

FWD Light Bar Reduced PWR

Activates light bar at reduced intensity.

Buggy Top (Optional)

Activates the lights above the upper helm.

Lights Dimming % Controls

Adjusts the intensity of the lights named below the control. Touch and slide the switch starboard to increase brightness. Touch and slide the switch port to decrease brightness. Intensity is indicated above each control.

Spreaders Reduce PWR

Reduces spreader light intensity.

All Spreaders Off

Touch to turn all spreader off simultaneously.

Electrical System

Additional 12 Volt Switches Trim Tab Control Panel

Located in the helm. This panel controls and monitors the ZipWake trim interceptors located on the transom of the boat. It is protected by a fuse in the house battery switch panel. Refer to the Helm Control Systems chapter for detailed information on the operation of the trim tab controls.

Engine Trim and Tilt Switches

Located in the helm. These switches are typically installed in the engine throttle and shift controls. They control the trimming and tilting of the engines. Refer to the Helm Control Systems chapter and the engine owner's manual for information regarding the proper use of the tilt and trim switches.

Spot Light (Optional)

Located in the helm. Controls the spot light that is mounted on the hardtop. It is protected by a fuse located in the accessory fuse panel behind the helm. Refer to the spot light owner's manual for details on operating the control pad.

Table

A three position momentary switch that raises and lowers the table pedestal located on the port side of the forward cockpit. The center position is OFF. Press and hold the top of the switch to raise the table, press and hold the bottom of the switch to lower it. The pedestal will stop immediately when the switch is released or when the table pedestal reaches full up or down position. It is protected by a fuse in the house battery switch panel.

Grill (Optional)

A three position momentary switch that raises and lowers the grill located on the starboard side of the transom. The center position is OFF. Press and hold the top of the switch to raise the grill, press and hold the bottom of the switch to lower it. The actuator will stop immediately when the switch is released or when the grill reaches full up or down position. It is protected by a fuse in the house battery switch panel.



Trim Tab Control Panel



Table UP/DOWN Switch

Electrical System



Head Control Switch Panel



Cabin Light Switch Panel

Marine Head Control Switch

Located in a panel near the marine toilet in the cabin. Controls the filling and flushing operations of the marine toilet. Refer to the Interior Equipment chapter for additional information on the operation of the marine toilet.

Waste Discharge Switch

A key activated momentary switch located in the head control panel that controls the overboard discharge pump system for the holding tank and marine head system. Monitor the waste level in the tank while pumping and turn the waste discharge switch OFF immediately when pumping is complete.

The key must be removed from the switch whenever the discharge pump is not being operated.

Cabin Light Switch Panel

Located near the cabin door. These switches activate the lights in the main cabin and head compartment.

12 volt Receptacles

Located in the helm switch panel, the cabin and in the cockpit at the bow. Provides electrical current for portable 12 volt equipment.

MP3/USB Connections

Located at the helm, in the cabin and in cockpit at the bow. Provide an input for MP3 players and USB drives to connect to the boat stereo system. The USB connections will charge cell phones and other portable electronics that are charged by a USB cord.



Forward Power Port



12 Volt Receptacle in Helm Switch Panel

Electrical System

Windlass Switch

A corded remote switch located in the windlass compartment below a hatch in the deck at the bow. This switch controls the windlass which is mounted in the compartment near the switch. It is protected by a circuit breaker of the type and rating recommended by the windlass manufacturer that is located near the battery switches.

SeaKeeper Display Panel (Optional)

The display is the user interface to the Seakeeper. It is used to start, operate, monitor and shutdown the Seakeeper. Sensors, alarms and shutdowns are provided to allow unattended operation.

The display also provides information in the event of an alarm. Alarms cause precession to stop and the Seakeeper to start coasting down.

Refer to the SeaKeeper operation manual for more information.

Light Mode Control Panel

Located at the helm. Controls the color and intensity of the lights in the optional JL LED speakers.

Inductive Phone Charger

A recessed phone charging pad located on the port side of the helm.



Windlass Control Switch

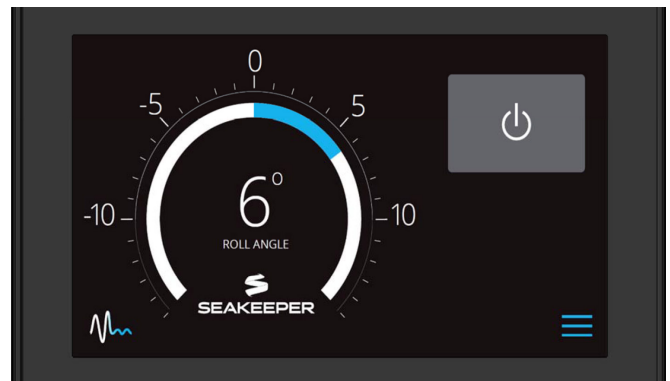

SeaKeeper Control Panel



Inductive Phone Charging Pad



Light Mode Control Panel



Digital Switch Control Screen

6.7 Digital Touch Control System

The digital touch switching system provides reduced complexity and increased switching options at the helm. The system consists of the touch control screens in the Garmin displays, digital switch panels and DC digital control output modules.

The electrical systems and accessories are monitored by various screens in the Garmin touch screen displays.

Display & Control Features

The display/control screens are the primary interface between the digital switch network and the user. They provide full control of circuits controlled by the digital switch panels as well as the ability to view selected onboard system information, such as tank levels and power levels for DC supplies. Circuit breakers in the control output modules protect the DC circuits activated by the module. Heavy duty main breakers protect the primary power circuit for each module.

Audio and visual alarms with systems diagnostics are also provided. The display screens are designed with a menu structure that is easy to follow. The "modes of operation" feature allows the control of multiple circuits with a single push of a button.

The following are some features that can be monitored or controlled with the digital control features on the Garmin display panels.

Modes of Operation

- Allows user to assign control of multiple DC circuits to a single switch.
- Allows user to dim or brighten selected light circuits.
- Allows users to activate or power down the DC electrical system from the onboard control panels.

Electrical System

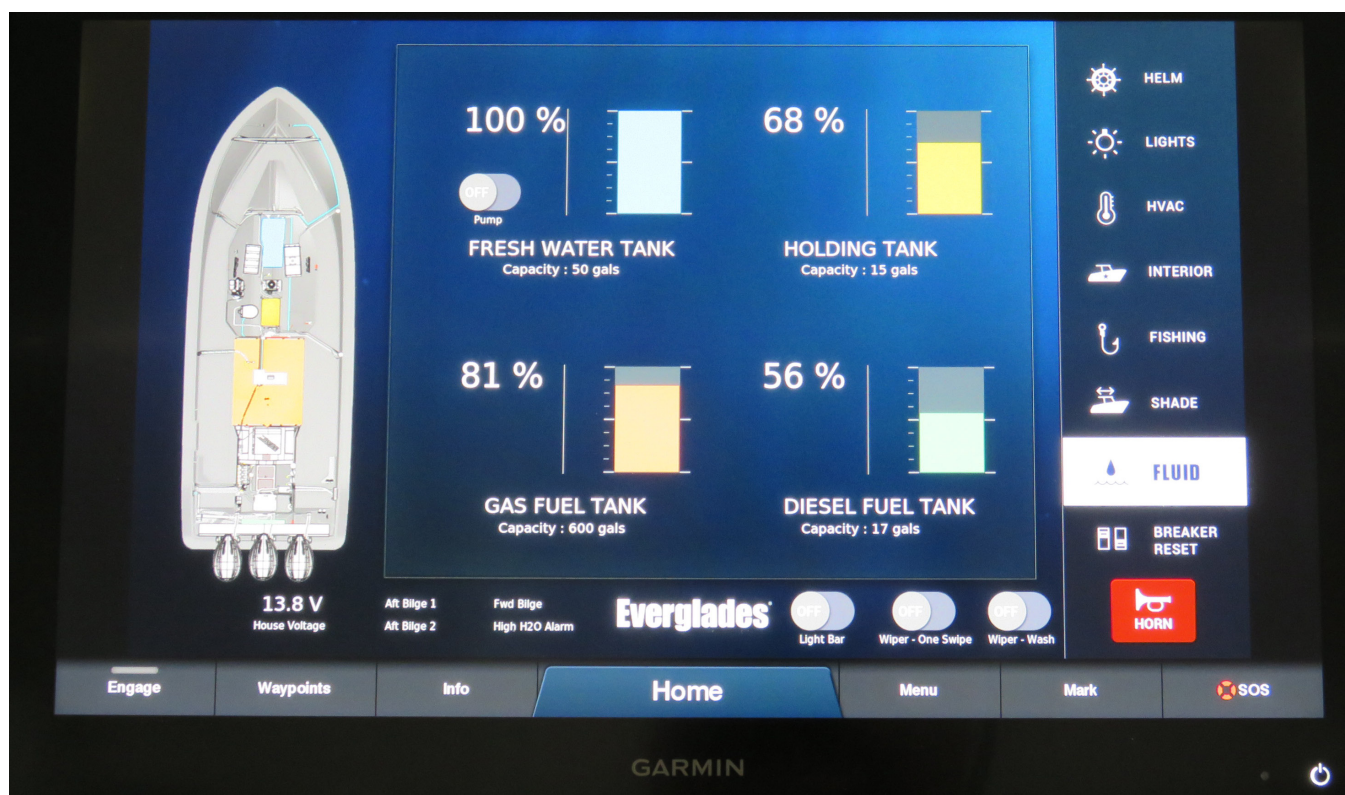

Fluid Level Monitoring Screen

Power Control

- Activates and monitors the DC powered sea-water and freshwater pumps.
- Activates and monitors the holding tank DC powered overboard discharge diaphragm pump for the waste tank.

DC Power Meter

- Displays voltages of engine and house batteries. Includes low and high voltage alarms.
- Displays battery capacity in ampere hours and % charge/discharge, includes low ampere hour alarm.
- Displays charge and discharge amps.

Fluid Levels

- View tank level information for water and waste tanks.
- View gas and diesel fuel tank level information.

Data

- Displays network information.
- Displays temperature and pressure values.
- Monitors all circuits connected to the digital network.



Power Control Screen

Alarms

- Digital network status reporting.
- Indicates alarms for onboard faults in audible and visual form (bilge pump operation, high bilge water level, smoke alarm).

Refer to the Garmin digital switching system operation manual for additional information on the features and operation of the digital control system.

Electrical System

Digital DC Electrical System Control Output Module Circuit Protection

Accessory circuits activated by the digital switches are protected by circuit breakers located in the output modules. The circuits controlled by each module are numbered and labeled for the accessory activated and protected by the module.

Most circuit breakers and control modules are located behind a hinged access door in the head compartment. To reset a circuit breaker in a control module, use the arrow buttons to scroll to the circuit with the blown breaker. Then press the RESET/AUTO switch to reset the breaker.

In addition to circuit protection, the control modules are equipped with a manual circuit bypass feature that allows any circuit controlled by an output module to be activated manually.

To bypass the controller and activate a circuit manually, use the arrow buttons to scroll to the circuit that needs to be activated. Then press the MAN ON/MAN OFF switch to activate the circuit. Press the MAN ON/MAN OFF switch again to deactivate the circuit.

Refer to the Garmin digital switching system operation manual for additional information on the digital switching system.



Digital Switch Control Modules & Main Circuit Breakers

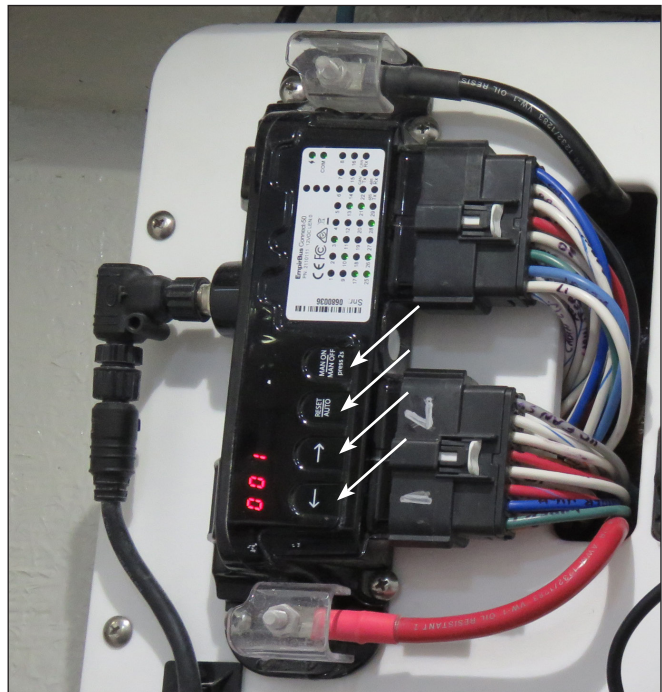

Digital Control Module
Circuit Breaker Reset & Manual Override Switches

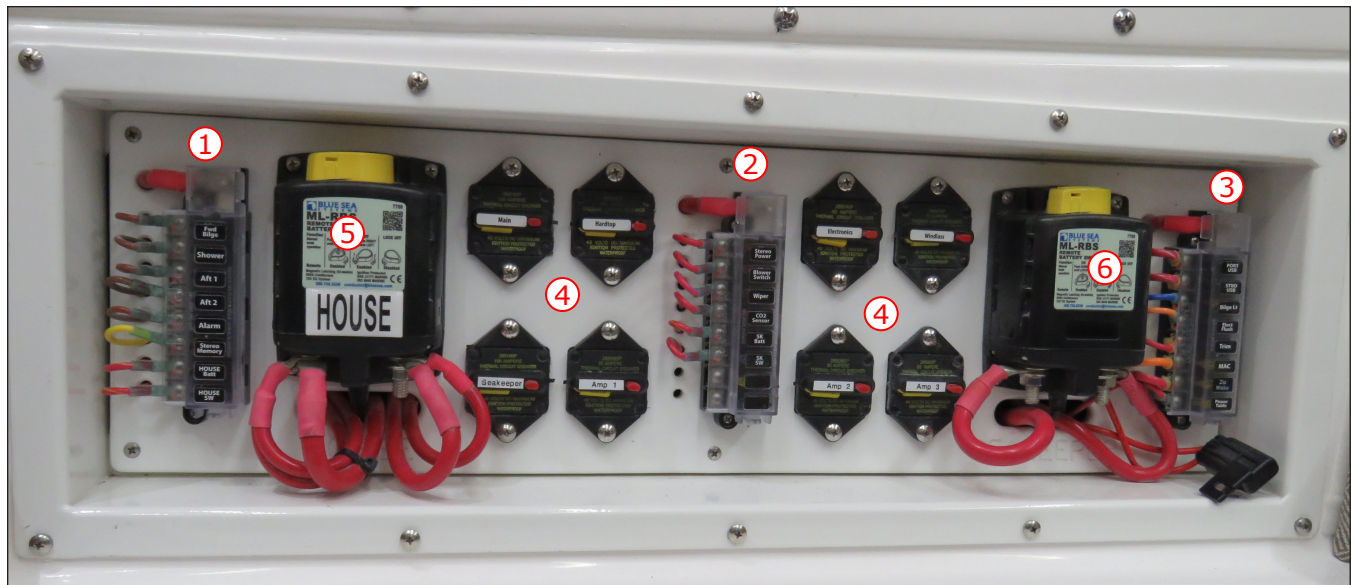

House Battery Switch Panel, Fuse Panels & Main Circuit Breakers
Located Behind Port Cabin V-Berth Backrest Cushion

- | | |
|--------------------------------|-----------------------------|
| 1. Continuous Power Fuse Panel | 4. Main Circuit Breakers |
| 2. Accessory Fuse Panel | 5. House Battery Switch |
| 3. Accessory Fuse Panel | 6. SeaKeeper Battery Switch |

6.8 DC System Circuit Protection

Power is distributed to most of the 12 volt accessories through individual circuit breakers in the digital switching control modules. Fuses located in fuse panels on the battery switch panels protect the circuits for the remote battery switches and continuous power circuits. Other fuse panels in the battery switch panels, behind the helm, and behind the upper helm protect the circuits for electronics and other accessories not protected by circuit breakers in the control modules

The fuses are labeled for the accessory circuit they protect. Blank fuse holders are reserved for additional accessories not usually installed by the factory.

If a fuse blows, it must be replaced with a fuse of the same amperage as the original. Fuses are labeled and color coded. Never try to correct a problem with a 12 volt accessory by installing a larger fuse. This could cause the accessory or circuit with a problem to overheat, which could result in an electrical fire.

The following is a description of the most common circuit breakers and fuse panels. Some accessory circuit breakers and fuses described in this section provide protection for optional equipment that may not be installed on your boat.

Main Circuit Breakers

DC Power is distributed to the fuse panels, helm switch modules, electronics and other main circuits through heavy duty circuit breakers located in the battery switch panels. These main circuits are deactivated when the house battery switch is off. The breakers are supplied power whenever the House battery switch is on.

Heavy duty breakers are equipped with a red "push to test" button and a black or yellow reset lever. If the circuit breaker is tripped by an overload, the yellow or black lever near the center of the breaker will be visible and pointing downward. Reset the breaker by pushing the lever until it resets and locks in the "ON" position. The circuit breaker can be tested for proper operation by pressing the red test button.

Notice:

If a main circuit breaker trips, always make sure the problem that caused the breaker to trip is found and corrected before resetting the breaker.

Electrical System



Engine Battery Switch Panel, Fuse Panels & Power Port Circuit Breakers
Located Behind Port Cabin V-Berth Backrest Cushion

1. Power Port Circuit Breakers
2. Engine Parallel Relay
3. Engine Battery Switches
4. Continuous Power Fuse Panel
5. Continuous Power Fuse Panel

The following are the main circuits supplied and protected by heavy duty circuit breakers:

Main

Protects the circuit that supplies 12 volt current to the digital switching modules, accessory switch panels and most DC accessories in the cabin and cockpit. This circuit is deactivated when the House battery switch is off.

Hardtop

Protects the circuit that supplies 12 volt current to the hardtop accessory circuits. This circuit is deactivated when the House battery switch is off.

Electronics

Protects the main circuit that supplies 12 volt current to the electronics fuse panels below the helm. This circuit is deactivated when the House battery switch is off.

Windlass

Protects the circuit that supplies 12 volt current to the windlass main circuit. This circuit is deactivated when the House battery switch is off.

Amp 1, 2 & 3

Protects the circuits that supply 12 volt current to the stereo amplifiers. These circuits are deactivated when the House battery switch is off.

SeaKeeper

Protects the circuit that supplies 12 volt current to the SeaKeeper main circuit. This circuit is deactivated when the House battery switch is off.

Remote Battery/Switch Fuses

These fuses protect the individual circuits for the remote battery switches at the helm. These are continuous power circuits which are always supplied current when the house batteries are connected.

House Battery/Switch

Protects the circuit for the switch that controls the remote battery switch for the House 12 volt electrical system.

Port Battery/Switch

Protects the circuit for the switch that controls the remote battery switch for the port engine 12 volt electrical system.

Mid Battery/Switch

Protects the circuit for the switch that controls the remote battery switch for the center engine 12 volt electrical system.

STBD Battery/Switch

Protects the circuit for the switch that controls the remote battery switch for the Starboard engine 12 volt electrical system.

Electrical System

Emer Parall

Protects the circuit for the switch that controls the emergency parallel remote battery switch that temporarily connects the engine batteries to provide additional starting current for those engines.

SK Batt/Switch

Protects the circuit for the switch that controls the remote battery switch for the SeaKeeper 12 volt electrical system.

Cockpit Power Port Circuit Breakers

These circuit breakers are mounted to the house battery switch panel. The circuit breakers are activated or reset by toggle switches in the panel above the engine parallel relay.

Continuous Power Fuses

These fuses protect circuits that are always active and not turned off by the battery switches. The continuous power circuits are always supplied current when the house batteries are connected.

The fuses in these panels provide continuous power and protect the circuits for the following accessories:

Stereo Memory

Protects the circuit that supplies continuous 12 volt electrical current to the memory circuit in the stereo.

Shower

Protects the circuit for the automatic switch that activates the shower sump pump located in bilge below the cabin sole.

Fwd Bilge

Protects the circuit for the automatic switch that activates the forward bilge pump located in the cabin bilge. A light in the forward Pump switch will be lit whenever the pump is activated.

Aft 1

Protects the circuit for the automatic switch that activates the aft bilge pump located in the aft bilge. A light in the Aft 1 Bilge Pump switch will be lit whenever the pump is activated.

Aft 2

Protects the circuit for the automatic switch that activates the emergency aft bilge pump located in the aft bilge behind the aft bilge pump. A light in the Aft 2 Bilge Pump switch will be lit whenever the pump is activated.

Alarm

Protects the circuit for the automatic switch in the aft bilge that activates the high water alarm. The high water alarm will sound to alert the operator of unusually high water in the bilge.

CO2 Sensor

Protects the circuit that supplies continuous 12 volt electrical current to the carbon monoxide detector in the cabin.

The power indicator on the carbon monoxide detector should be lit whenever someone is occupying the cabin. If the fuse has blown, it indicates that there is a problem with the carbon monoxide detector or the wiring from the fuse panel to the detector. Always determine the cause of the problem and correct it before replacing the fuse or occupying the cabin.

Notice:

The continuous power circuit fuses are always supplied current when the batteries are connected. These circuits are not deactivated when the battery switches are off.

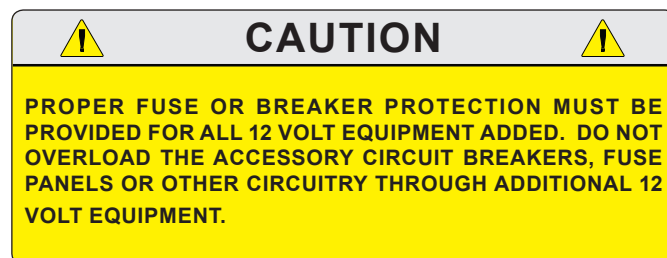

Accessory Fuses

These fuses protect circuits that are not protected by the circuit breakers in the digital switch control modules. These circuits which are supplied current when the house battery switch is on.

Port USB

Provides protection and power for the port 12 volt accessory/USB plug.

STBD USB

Provides protection and power for the starboard 12 volt accessory/USB plug.

Bilge Lt

Provides protection and 12 volt power for the light in aft systems compartment.

Electrical System

Elect Flush

Provides protection and 12 volt power to the control panel for the marine toilet.

Trim

Provides protection and 12 volt power to the primary circuit for ZipWake or lectortab trim system.

MAC

Provides protection and 12 volt power to the macerator pump.

Power Table

Provides protection and 12 volt power to the switch that raises and lowers the bow table.

Generator Fuse Panel

A fuse panel is typically installed on the generator near the controls to protect the DC circuits.

Electronics and Accessory Fuse Panels

There are other fuse panels located behind the upper and lower helm stations and in the compartment behind the hardtop electronics panel that are supplied power by the DC Main and/or Electronics main breakers located in the electrical systems compartment. Fuses in the panels protect the individual circuits for electronics or other accessories mounted in your boat. The circuits are labeled for the electronics or accessories they protect. The circuits in these panels are deactivated when the House battery switch is off.

The helm electronics fuse panels are accessed through a hatch in the rear cabin bulkhead. The accessory fuse panel in the hardtop compartment is accessed by removing the faceplate panel on the hardtop.

Digital Switching Control Module Main Circuit Breakers

The main circuit for each digital switching system control module is protected by a heavy duty circuit breaker located near the module. Most control modules are located behind a hinged access panel in the head compartment.

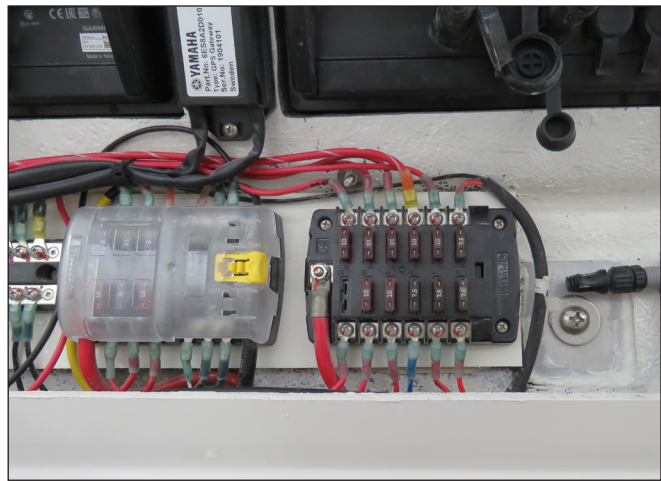

Electronics and Accessory Fuse Panels Behind Helm

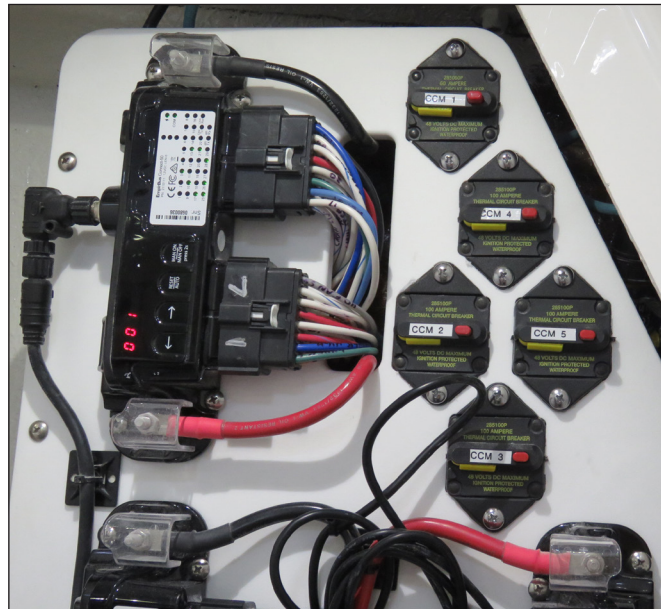

Digital Switching Control Module Main Circuit Breakers

Electrical System

Helm Master Main Circuit Breakers

Boats with Yamaha Helm Master Electronic Steering systems are equipped with a heavy duty circuit breaker for each engine steering pump in the aft systems compartment. These breakers protect the steering pumps from an overload.

Notice:

Circuit protection for other engines, controls, and steering systems may be different. Refer to the engine owner's manual for information on circuit protection and amperage requirements for the engines and control systems on your boat.



Typical Helm Master Circuit Breakers

6.9 DC Power Management

Your boat is typically equipped with a full array of electronics, fuel injected engines, stereo amplifier, spreader lights and could be equipped with a SeaKeeper or other accessories that consume a significant amount of DC electrical power. All outboard engine charging systems are designed to provide maximum electrical output at or above cruising RPM. The electrical output from the charging system is considerably less at idle or trolling speeds.

Depending on the optional equipment and electronics installed on your boat, there may be times when the charging systems on your engines will not be able to meet the DC electrical power demand if too many accessories are activated while the boat is operating at idle or trolling speeds. Consequently, POWER MANAGEMENT PRACTICES may need to be observed at slow speeds, particularly if your boat is equipped with a full electronics package and a SeaKeeper.

The house battery system is designed to provide several hours of reserve capacity, which is adequate for most situations. However, you should be aware of the load each of your DC accessories draw and make sure you don't overload the capacity of the charging system for extended periods while operating the boat below cruising speed. Always monitor the volt meters while operating at

slow speeds and turn off unnecessary equipment that draw high amperage loads if the volt meters indicate that the voltage in the batteries is below 12 volts. If necessary, reduce the electrical load by turning off or alternating the use of high draw DC accessories such as the SeaKeeper, radar units, stereo, spreader lights, etc.

If the house battery system that powers the electronics and accessories on your boat becomes critically discharged while underway at low speeds or trolling, make sure that you turn off all unnecessary DC equipment and run the boat engines at an RPM that will provide a reading of the at least 13 volts on the volt meters to recharge the house batteries. Proper DC power management will prevent low voltage that can cause critical navigation equipment to become erratic or shutdown unexpectedly. Additionally, sound power management practices increase the life of your batteries and engine charging systems. You should contact your dealer if you have any questions regarding DC power management or the DC electrical system on your boat.

Electrical System

6.10 120 Volt AC Electrical System Overview

The AC electrical system is supplied 120 volt, 60 cycle current by 30 amp shore power inlets at dockside or by the generator. It is wired totally separate from the 12 volt DC system and is equipped with an onboard isolation system.

There are one or two 30 amp inlet plugs, depending on the options selected, mounted on the starboard transom. One inlet (Shore 1) for the 120 volt AC system and one inlet (Shore 2) for the optional cockpit air conditioning and refrigerator systems.

Notice:
If the optional cockpit air conditioner and refrigeration options are not selected, there will only be one inlet plug and shore power cable.

Main circuit breakers that protect each circuit from the shore inlets to the cabin AC panel and Equipment Leakage Circuit Interrupters (ELCI) are located in panels on the starboard rear side of the cockpit.

Equipment Leakage Circuit Interrupters provide whole-boat ground fault protection (electrical shock protection from stray current) for the entire AC shore power system. They also protect the system from reverse polarity problems due to an improperly wired shore power supply.

The AC system can be fed by either the shore power inlets or the generator. A SHORE/OFF/GENERATOR selector switch in the AC panel is used to select the source of power desired. All AC accessory circuit breakers should be switched to the OFF position before selecting a different power source.

AC current is distributed to the AC accessories through individual circuit breakers located in the cabin AC panel. The inlet main breakers protect the system from an overload. All AC outlets in the cabin and cockpit are protected by ground fault interrupters to protect against electrical shock.

While moored dockside, 120 volt AC power should be utilized from dockside power, if available. Cord sets are provided to supply power from the shore power outlets to the boat's 120 volt AC and HVAC systems.



Cabin AC Panel

⚠ **DANGER** ⚠

TO REDUCE THE RISK OF ELECTRICAL SHOCK IN WET WEATHER, AVOID MAKING CONTACT WITH THE SHORE CABLES OR MAKING A CONNECTION TO A LIVE SHORE OUTLET. NEVER SPRAY WATER ON ELECTRICAL CABLES WHILE WASHING DOWN DECKS.

TO REDUCE THE POSSIBILITY OF AN ELECTRICAL SHOCK, IT IS IMPORTANT THAT THE AC GROUND SYSTEM IS FUNCTIONING PROPERLY AND THAT A PROPER CONNECTION EXISTS BETWEEN THE SHORE POWER CORDS, THE SHORE POWER INLETS, THE BOAT BONDING SYSTEM AND THE OUTLET GROUND CIRCUITS. IF THERE IS ANY DOUBT ABOUT THE INTEGRITY OF THE GROUND CIRCUIT, A QUALIFIED MARINE ELECTRICIAN SHOULD BE CONTACTED IMMEDIATELY AND AC POWER SHOULD BE DISCONNECTED UNTIL THE NECESSARY REPAIRS ARE COMPLETED.

Electrical System

Recommended procedure for making a shore connection:

Turn the AC shore inlet Main breakers and the SHORE/OFF/GENERATOR selector switch in the cabin AC panel to the OFF position. If the dockside outlets include a disconnect circuit breaker, turn them off as well.

To avoid strain on the cables, make sure they have more slack than the mooring lines. Dress the cables so they cannot be damaged by chafing between the boat and the dock. Make sure the cables don't come in contact with the water and connect them to the boat inlet plugs and then the dockside outlets, making sure the connection plugs include a three-prong plug with a ground wire. Press the cords firmly into the boat inlet plugs until the side locks on the cord snap to the inlet plug. Close the cover on the cord to engage the cover lock. Secure lock rings on the shore connector plugs.

Turn the dockside disconnect circuit breakers to the ON position. Then turn the circuit breakers for the boat inlet connections on and check for proper polarity. If reversed polarity has been achieved, the red "FAULT" light on the ELCI panel will light and the main inlet breaker will automatically trip. If this should happen, make sure the inlet main breakers and SHORE/OFF/GENERATOR selector switch in the cabin AC panel are in the OFF position, then turn the dock power breaker off. If the green "POWER" light illuminates and neither main inlet breaker trips when power is supplied to the panel, polarity is correct and the SHORE/OFF/GENERATOR selector switch on the cabin AC panel can be moved to the "SHORE" position.

After activating the system, check the ELCI panels at the inlet main breakers for faults. The green "POWER" LED should show steady illumination and the red "FAULT" LED should remain off. The ELCI trips and opens the main circuit when there is a ground fault condition. If the red "FAULT" LED is continuously illuminated, the ELCI has tripped due to a ground fault condition. Some faults are self-clearing. Try resetting the ELCI once. If the green LED shows steady illumination and the ELCI does not trip again, the circuit is correct and activated.

If the ELCI continues to trip and the red "FAULT" LED is lit after being reset, there is a problem with the AC electrical system and it is unsafe to use.



120 Volt Inlet Plugs

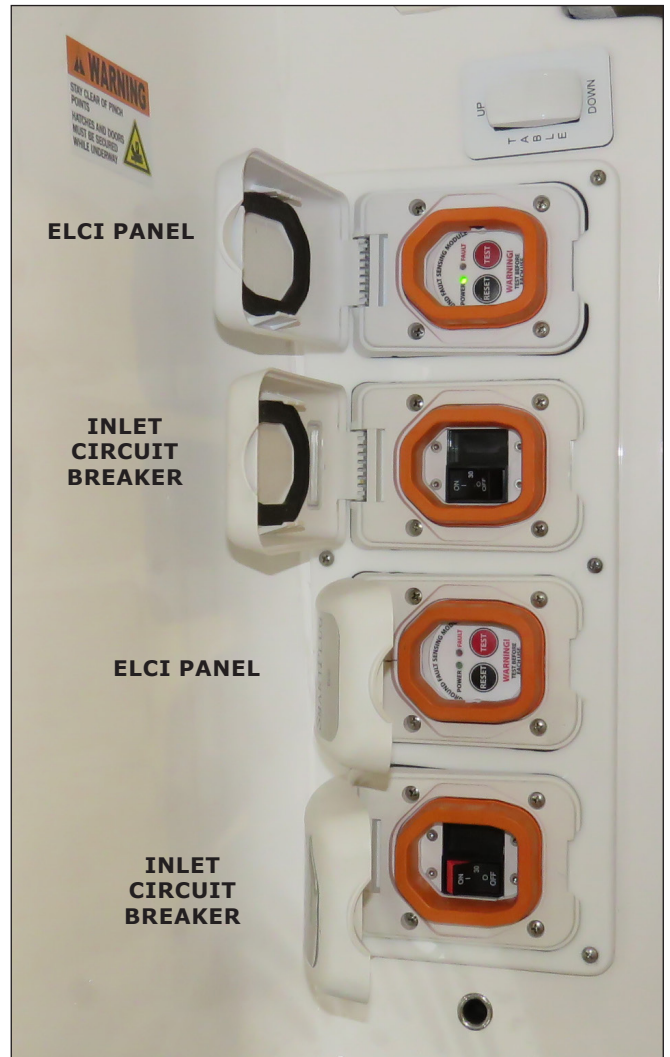

ELCI Panels & Inlet Breakers for Two Shore Power Inlet Plugs

Electrical System

Make sure the inlet connection main breakers and the SHORE/OFF/GENERATOR selector switch on the cabin panel are in the "OFF" position and turn the dock power breakers off. Disconnect the shore power supply cords from the boat and notify a qualified marine electrician to check the wiring and correct the problem.

⚠ DANGER ⚠

REVERSED POLARITY AND GROUND FAULT CONDITIONS WILL DAMAGE THE SYSTEM AND EXPOSE PASSENGERS TO ELECTROCUTION HAZARDS THAT WILL CAUSE SEVERE INJURY OR DEATH. THIS CONDITION COULD ALSO CAUSE A FIRE IN THE ELECTRICAL SYSTEM. NEVER OPERATE THE AC ELECTRICAL SYSTEM WITH REVERSED POLARITY OR A GROUND FAULT CONDITION.

⚠ WARNING ⚠

ELECTRIC SHOCK CAN CAUSE SEVERE INJURY OR EVEN DEATH. DO NOT ATTEMPT TO CORRECT THE WIRING YOURSELF. ALWAYS HAVE A QUALIFIED ELECTRICIAN CHECK WIRING.

KEEP CHILDREN AWAY FROM ANY ELECTRICAL CABLES OR EQUIPMENT AND ALWAYS USE GROUNDED APPLIANCES ONBOARD YOUR BOAT.

UNDETECTED FAULTS IN THE AC ELECTRICAL SYSTEM COULD CAUSE THE WATER AROUND THE BOAT TO BECOME ENERGIZED. THIS COULD CAUSE A SEVERE SHOCK OR EVEN DEATH TO SOMEONE IN THE WATER NEAR THE BOAT. NEVER SWIM OR ALLOW SWIMMING AROUND THE BOAT WHEN THE AC SYSTEM IS ACTIVATED BY THE SHORE POWER CONNECTION OR THE GENERATOR.

Disconnecting procedure for shore power connection:

Turn the AC panel accessory breakers and SHORE/OFF/GENERATOR selector switch to the OFF position. Turn the main inlet breakers off, then turn off the disconnect breakers on the dockside outlets.

Disconnect the cables from the dockside outlets and replace the outlet caps. Disconnect the cables from the boat and close the inlet caps. Store cables.

Equipment Leakage Circuit Interrupter (ELCI)

The ELCI provides whole-boat ground fault protection (electrical shock protection from stray current) for the entire AC shore power system. The ELCI face plates are equipped with TEST and



ELCI Panel & Inlet Main Breaker

RESET buttons. There are also two LED lights that indicate circuit status. When the 120 volt AC system is activated, the green "POWER" LED should show steady illumination and the red "FAULT" LED should remain off.

The ELCI trips and opens the main circuit when there is a ground fault condition. If the red "FAULT" LED is continuously illuminated, the ELCI has tripped due to a ground fault condition. Some faults are self correcting. If it trips, try resetting the ELCI once. If the green LED shows steady illumination and the ELCI does not trip again, the circuit is OK. If the ELCI continues to trip and the red LED is lit after being reset there is a problem with the AC electrical system and it is unsafe to use. Make sure all main breakers are turned off and notify a qualified marine electrician to check the wiring and correct the problem.

It is important that each ELCI is working properly to provide protection against electric shock. They should be tested at least once each month to ensure proper operation by pressing the TEST/RESET buttons in the faceplate. Refer to the ELCI instructions for the testing procedure.



120 Volt AC Panel

6.11 Cabin 120 volt AC Circuit Breaker Panel

The AC panel is located in a cabinet at the rear of the cabin. The following is a description of the AC panel equipment and the breakers that protect the accessories:

AC Multimeter

The multifunction meter monitors the voltage, current load or frequency when the boat is connected to AC power. Buttons below the meter allow you to select display options.

The voltage should be checked each time the AC system is activated. The AC system and acces-

sories can be damaged by voltage that is below 105 volts or above 125 volts. You should monitor the voltage and never operate your AC electrical system if the voltage is below or above this range.

The amp or current load should be monitored particularly when operating the air conditioners and water heater. You should always be aware of the electrical load needed to activate accessories and manage the amperage being supplied so the load can be kept within safe limits. Avoid excessive current load that can overload the circuits or the generator. If you have any questions about managing the power in your boat, contact your authorized Everglades dealer.

Electrical System

The frequency should be monitored when the generator is operating. In the United States, AC accessories are designed to operate on a frequency of 60 cycles per second. The generator should be able to maintain this frequency within + or - 3 cycles. Do not operate the AC electrical system if the frequency is not in the proper range.

Refer to the meter owner's manual for more information on the features and operation of the AC Multimeter.

SHORE/OFF/GENERATOR Selector Switch

The shore AC system includes one or two power cords and inlet connectors, depending on the options selected. One cord that supplies Shore main breaker 1 is standard. The other cord is optional and supplies Shore main breaker 2. This switch is used to select the main power source, either shore power or generator.

A power surge can occur when changing or activating the AC power source. The resulting power surge that occurs may cause the inlet main breakers or generator main breaker to trip. To avoid this surge, always turn all AC panel accessory breakers to the OFF position before changing or activating the power source.

When connected to dockside power, turn the switch to the SHORE position to energize the panel. When using the generator, turn the switch to the GENERATOR position to energize the panel. Turn the switch to the OFF position when shore power or the generator are not being used.

Shore 1, Shore 2/HVAC and Generator Main Breakers

The shore inlet breakers protect the primary 120 volt circuits when SHORE is selected. A main circuit breaker on the generator protects primary 120 volt circuits when GENERATOR is selected. Remember that these breakers are very sensitive. The resulting power surge that occurs when connecting dockside cords or switching the power source may cause a breaker to trip. To avoid this surge, always turn all AC panel accessory breakers off before activating or switching the power source.

Care must be taken when operating the AC system from the generator or shore power supply lines. In some situations, it may be possible to overload the generator or shore power circuits if too many AC accessory breakers are activated. Too much



SHORE/OFF/GENERATOR Switch & Multimeter

amperage being supplied through the panel will cause the Shore main breakers or generator main breaker to trip and could damage the system. This is particularly important when operating the air conditioners and water heater.

You should always be aware of the electrical load needed to activate accessories and manage the amperage being supplied so the load can be kept within safe limits. If you have any questions about managing the power in your boat, contact your authorized Everglades dealer.

Reversed Polarity Lights

The red lights indicate reverse polarity current supplied to the panel for each circuit. This situation will cause the red light to remain lit. If reverse polarity is achieved, immediately turn off all cabin AC breakers, the power selector switch and dockside outlet breakers. Disconnect the power cables from the dockside outlets and notify a qualified marine electrician to check the dockside wiring.

Stereo

The stereo is mounted in the AC Panel below the multimeter & selector switch.

Electrical System

Battery Charger 1 & 2

Supplies electrical current directly to the automatic battery chargers. The battery chargers will charge and maintain the 12 volt batteries simultaneously when activated. They are fully automatic.

There are two 60 amp battery chargers, one for the engine starting batteries and one for the house batteries and the batteries that power the SeaKeeper when this option is installed. The wires that supply DC charging current to the batteries are protected by an internal fuse in the battery chargers and external fuses, one for each battery output wire near the batteries. The external fuses protect the DC charging circuit from the batteries to the charger. The internal fuses in the chargers protect the DC charging circuit from the charger to the batteries. Refer to the battery charger owner's manual for more information on the features and operation of the battery charger.

The charge to the engine batteries can be monitored by using the volt meters in the engine gauge cluster, meters in the charger control panels on the AC panel or the meters on each charger. To monitor the engine start batteries with the volt meters in the engine gauge cluster, activate the charger and turn the engine battery switches on. Turn the ignition switch for each engine to the "ON" position (DO NOT START THE ENGINES) and read the voltage on the volt meter for each engine. If the batteries are in good condition and charging properly, the volt meters will indicate between 12 and 14.5 volts. If the reading is below 12 volts, then the battery is not accepting a charge or the charger is not working properly. Always turn the ignition switches off immediately after the monitoring is complete when using the voltmeters in the engine gauge cluster. The charge to the house or Seakeeper batteries is monitored using the meters in the AC panel or on the charger.



Typical Battery Charger



Battery Charger Control Panel & Meter in AC Panel

Electrical System

Water Heater

Supplies electrical current directly to the water heater circuit. A thermostat in the water heater control panel automatically controls the water temperature. Before operation, you must have water in the water heater. (See the water heater manual for details)

Outlets

Supplies 120 volt AC electrical current to the cabin Ground Fault Interrupter (GFI) outlets.

Notice:

All AC electrical outlets are provided with ground fault interrupts to protect against electric shock. These outlets should be tested periodically to ensure proper operation by pressing the test/reset buttons in the center of the faceplate. GFI outlets do not protect against short circuits and overloads. This is done by the Outlets breaker on the AC panel.

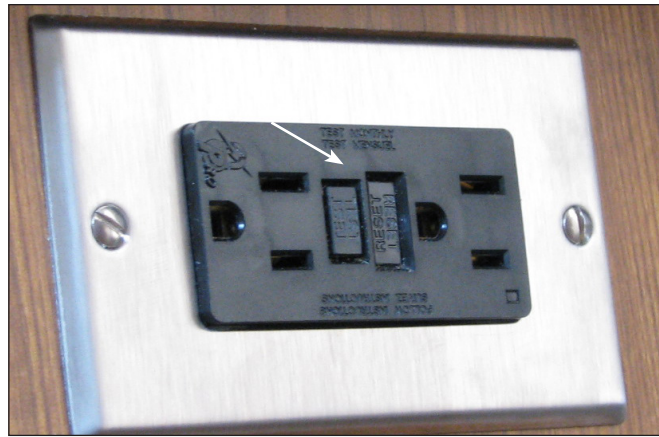

Typical GFI Outlet Test & Reset Buttons



WARNING



GFI OUTLETS DO NOT PROVIDE 100% PROTECTION FROM ELECTRIC SHOCK. EVEN THOUGH GROUND FAULT INTERRUPTERS PROVIDE PROTECTION BY REDUCING EXPOSURE TIME FROM LINE TO GROUND SHOCK HAZARDS, IT IS STILL POSSIBLE TO RECEIVE AN ELECTRIC SHOCK FROM DEFECTIVE APPLIANCES OR POWER TOOLS AND MISUSED ELECTRICAL EQUIPMENT.

HVAC Unit Forward

Supplies electrical current to the air conditioner compressor and control panel located in the cabin.

HVAC Unit Cockpit (Optional)

Supplies electrical current to the cockpit air conditioner compressor and control panel.

HVAC Pump

Supplies electrical current to the seawater pump in the aft systems compartment that circulates seawater through the air conditioning units. The pump runs whenever an air conditioning unit is operating.

Notice:

After a certain amount of time without water flow, the air conditioning unit will automatically power down. If this occurs, reset the unit and check for water flow out of the air conditioning thru-hull. Refer to the air conditioner owner's manual for more information.

TV/KVH

Supplies 120 volt AC electrical current to the TV and satellite antenna.

Cockpit Grill (Optional)

Supplies 120 volt AC electrical current to the electric grill in the cockpit.

Cockpit Refrigerator

Supplies 120 volt electrical current directly to the refrigerator in the cockpit when AC power is available and chosen over the 12 volt power supply. See the refrigerator manual for more information.

Electrical System

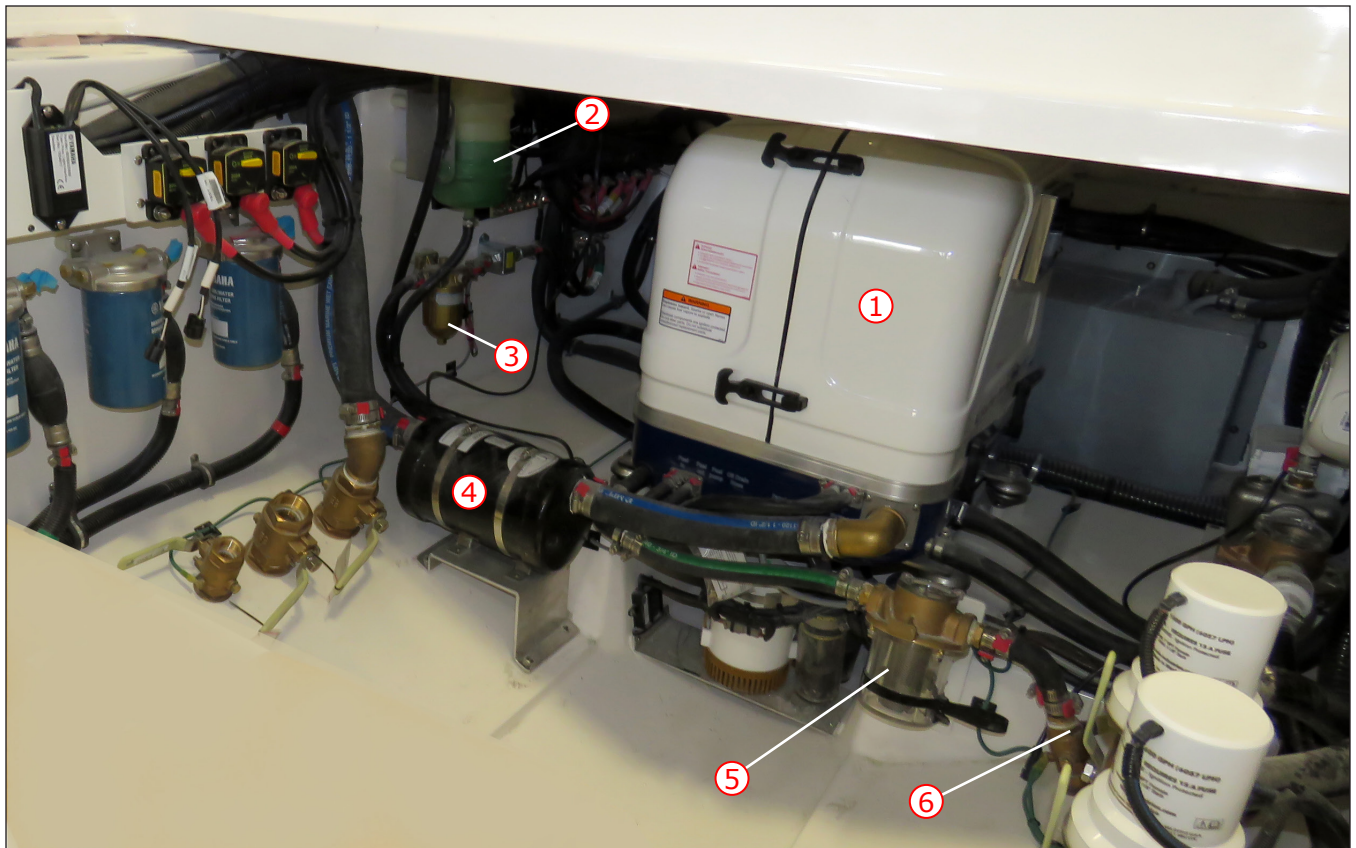

Typical Generator in Aft Systems Compartment

- | | |
|---------------------------------|------------------|
| 1. Generator | 4. Muffler |
| 2. Coolant Recovery Tank | 5. Sea Strainer |
| 3. Water Separating Fuel Filter | 6. Seacock Valve |

6.12 Generator

The generator is supplied 12 volt power for the ignition and starter motor by the House battery bank and is located in the aft systems compartment. The generator oil and coolant should be checked whenever you check the oil in the main engines.

Switches in the cabin generator control panel control the starting, running and stopping of the generator. Indicator lights and an LED display in the panel monitor engine temperature, exhaust temperature and oil pressure.

The generator can also be operated from an override control panel on the generator. The circuit breakers and fuses that protect the generator AC and DC circuits are also on this panel. An owner operator's manual for the generator has been supplied with this manual. Please refer to it for details on generator operation and circuit protection.



Generator Control Panel

Electrical System

The generator engine uses a closed cooling system with a seawater-cooled heat exchanger. A sacrificial anode in the seawater cooling system protects generator components that are in contact with seawater. There is a coolant recovery tank for the engine coolant mounted on the stringer near the generator. Make sure the fluid level in the coolant recovery tank is kept between the maximum and minimum lines of the tank. **You should also check the exhaust port for water flow each time the generator is started.** If there is no discharge within thirty seconds, shut down the generator, then find and correct the problem.

The seawater cooling system includes a strainer that prevents debris in the seawater from entering the cooling pump. The strainer and a seacock valve is located in the aft systems compartment bilge near the generator. It is important to check and clean the strainer regularly to ensure the seawater system can circulate enough water to provide cooling for the closed cooling and exhaust systems on the generator. You should also make sure the generator seacock valve is open and check the exhaust port for water flow each time the generator is started. If there is no discharge within thirty seconds, shut down the generator and find and correct the problem.

Refer to the Raw Water Systems Maintenance section in the Raw Water System Chapter of this manual for instructions on cleaning the generator sea strainer.

Notice

The generator may not be able to operate all 120 volt accessories at the same time. POWER MANAGEMENT PRACTICES may need to be observed depending on the AC power load.

Notice:

Generators consume DC electrical current and charge the House batteries just enough to compensate for the DC electrical current the engine requires to operate. Therefore, it is important to activate the battery chargers to maintain the House and Engine batteries whenever the generator is running.

The generator diesel fuel system is different than the fuel system for the main engines. Refer to the Fuel System chapter for more information on generator fuel system.



Fuses, Circuit Breakers & Manual Override Switch



Generator Sea Strainer & Seacock Valve

You also should read the generator owner's manual for detailed information on the safe operation and maintenance of the generator.

⚠ **DANGER** ⚠

GENERATOR ENGINES PRODUCE CARBON MONOXIDE WHICH IS A LETHAL, TOXIC GAS THAT IS COLORLESS AND ODORLESS. IT IS A DANGEROUS GAS THAT WILL CAUSE DEATH IN CERTAIN LEVELS. ONLY OPERATE THE GENERATOR IN WELL VENTILATED AREAS AND NEVER OPERATE THE GENERATOR WHILE YOU ARE SLEEPING.

Electrical System

6.13 Bonding System & Galvanic Isolator

Your boat is equipped with a bonding system that interconnects all underwater metal hardware and thru-hull fittings to ensure that they are of the same electrical potential. Anodes are attached to the bonding system at the transom and the engines. There is also an anode in the seawater cooling system for the generator. Anodes deteriorate before the other metals, thereby protecting underwater metals from galvanic corrosion or stray electrical current. Since the anodes are sacrificial, it is important to monitor them and replace them when they have deteriorated to 50 - 75% of their original size.

The bonding system is connected to the DC ground and the earth ground wire for the AC electrical system. It provides a path for dangerous short circuits in the AC electrical system to the safety earth ground in the event of a fault in the shore earth ground connection and when the boat is away from the dock.

When the boat is connected to shore power at a marina or city dock, all boats connected to shore power are connected to a common shore safety earth ground connection. This circuit provides essential protection against electrical shock from faults or short circuits in AC electrical equipment and, unfortunately, provides a path for low voltage galvanic current to flow between the bonding system of other boats in the circuit. If one or more of the boats in the circuit has a stray current electrical problem or is not equipped with proper galvanic protection, it will seek protection from your boat's bonding system through the safety ground circuit. This could cause accelerated deterioration of the anodes and/or severe damage to the underwater hardware. To prevent damage from other boats in the circuit, a galvanic isolator is installed in the shore ground circuit that isolates your boat's bonding system from the other boats. It prevents the flow of low voltage galvanic current while still providing a path for dangerous short circuit currents in the AC system to the shore safety ground.

6.14 Electrical System Maintenance 12 volt AC Electrical System Maintenance

At least once a year, spray all exposed electrical components behind the helm, in the transom area and in the plugs with a protector. Removable light fixture lenses should be removed and wiped clean

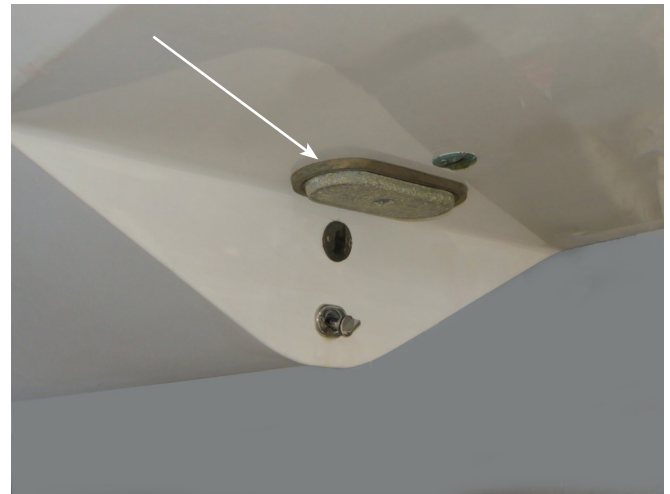



Transom Sacrificial Anode



Typical Bonding Wires & Connections

with a damp cloth and reinstalled. Some LED light fixtures are sealed and not serviceable.

	CAUTION	
WHEN REPLACING LIGHT BULBS IN MARINE LIGHT FIXTURES, ALWAYS USE A BULB WITH THE SAME RATING AS THE ORIGINAL. USING A DIFFERENT BULB COULD CAUSE THE FIXTURE TO OVERHEAT AND MELT OR SHORT CIRCUIT.		

Electrical System

Inspect all wiring for proper support, sound insulation and tight terminals, paying particular attention to portable equipment power cords and plugs.

Check all below deck wiring to be sure it is properly supported, that the insulation is sound, and that there are no loose or corroded terminals. Corroded terminals should be thoroughly cleaned with sandpaper or replaced, tightened securely and sprayed with a metal and electrical protector. Inspect all engine wiring.

Notice:
AGM batteries are sealed and do not require or allow the inspection of the electrolyte.

Keep the battery tops clean and dry. Dirt and water can conduct electricity from one post to the other causing the battery to discharge.

Battery posts should be kept free of corrosion. Remove the cables and clean the posts and cable clamps with a battery post cleaner or sandpaper as required. Coating the battery posts and cable clamps with petroleum jelly or dielectric silicone grease will protect them and reduce corrosion.

Battery cables, both hot and ground, must be replaced when they show signs of corrosion or fraying. Deteriorated cables cause a considerable voltage loss when high currents are drawn, as for starting the engines.

AC Electrical System Maintenance

Periodically inspect all wiring for nicks, chafing, brittleness, improper support, etc. Examine the shore power cord closely for cracks in the insulation and corrosion in electrical connectors. Spraying receptacles and electrical connections with an electrical contact cleaner or a metal and electrical protector will reduce corrosion and improve electrical continuity.



Inspect all wiring for proper support, sound insulation and tight terminals, paying particular attention to portable appliance cords and plugs. The entire AC circuitry, especially the shore power cords, should be seasonally tested for proper continuity by an experienced electrician. This will detect any shorts, open wires or ground faults.

Ground fault interrupt outlets and ELCI should be tested monthly to ensure proper operation by pressing the test/reset buttons. The reverse polarity system should also be inspected and tested periodically for proper operation.

Generator Maintenance



The engine maintenance required on the generator is similar in many ways to the main engines. The most important factors to the generator's longevity are proper ventilation and maintenance of the fuel system, ignition system, cooling system, lubrication system and the AC alternator.

Maintenance schedules and procedures are outlined in your generator owner's manual. They should be followed exactly.

 **DANGER** 

NEVER USE WET CELL BATTERIES. WET CELL BATTERIES EMIT DANGEROUS HYDROGEN GAS WHILE BEING CHARGED. HYDROGEN GAS CAN EXPLODE IF A FLAME OR SPARK IGNITES THE GAS, WHICH WILL RESULT IN SEVERE INJURY OR DEATH.

THE BATTERY COMPARTMENT IS NOT DESIGNED TO VENTILATE DANGEROUS HYDROGEN GAS TO THE ATMOSPHERE WHICH COULD ALLOW THE GAS TO ACCUMULATE TO DANGEROUS LEVELS. ABSORBED GLASS MAT (AGM) BATTERIES DO NOT EMIT HYDROGEN GAS AS THEY RECHARGE. USE ONLY ABSORBED GLASS MAT (AGM) BATTERIES IN THIS BOAT.

 **WARNING** 

CORROSION ALLOWED TO BUILD ON THE ELECTRICAL CONNECTORS CAN CAUSE A POOR CONNECTION RESULTING IN SHORTS, GROUND FAULTS OR POOR GROUND CONNECTIONS. ELECTRICAL CONNECTORS SHOULD BE CHECKED AT LEAST ANNUALLY AND CLEANED AS REQUIRED. DO NOT ALLOW CORROSION TO BUILD ON CONNECTIONS.

ELECTRIC SHOCK CAN CAUSE SEVERE INJURY OR EVEN DEATH. THE AC AND DC ELECTRICAL SYSTEMS ALWAYS SHOULD BE DISCONNECTED FROM THE POWER SOURCE BEFORE INSPECTING OR SERVICING THE SYSTEM. NEVER SERVICE ANY COMPONENT OF AN ELECTRICAL SYSTEM WHILE IT IS ENERGIZED.

NOTES

FRESH WATER SYSTEM

7.1 General

The fresh water system consists of a potable water tank, distribution lines and a distribution pump. The pump is equipped with an automatic pressure switch and is located near the tank in the cabin below the V-berth.

CAUTION

DO NOT FILL SYSTEM WITH ANYTHING OTHER THAN WATER. SHOULD THE SYSTEM BECOME CONTAMINATED WITH FUEL OR OTHER TOXIC FLUIDS, COMPONENT REPLACEMENT MAY BE NECESSARY.

WARNING

DO NOT CONFUSE FUEL FILL DECK PLATES WITH THE WATER OR WASTE FILL DECK PLATES. THESE PLATES ALSO ARE LABELED ACCORDINGLY. IF GASOLINE OR DIESEL FUEL IS ACCIDENTALLY PUMPED INTO THE WATER OR WASTE TANK, DO NOT ATTEMPT TO PUMP IT OUT YOURSELF. WATER AND WASTE PUMPS ARE NOT DESIGNED TO PUMP FUEL AND A FIRE OR EXPLOSION COULD RESULT. CONTACT YOUR DEALER OR THE EVERGLADES CUSTOMER SERVICE DEPARTMENT FOR ASSISTANCE IN HAVING THE FUEL PROFESSIONALLY REMOVED AND COMPONENTS OF THE FRESH WATER SYSTEM REPLACED AS NECESSARY.



Fresh Water Pump & Tank



Mezzanine Sink

7.2 Fresh Water System Operation

Fill the water supply tank slowly through the labeled deck plate located on the starboard gunnel. After filling the water tank, partially open all faucets. The Fresh Water Pump switch should be on. Allow the pump to run until all of the air is purged from the system and a steady stream of water is flowing from each outlet. Next, turn off the faucets one by one. As water pressure builds, the pump will automatically shut off.

When properly primed and activated, the system will operate much like the water system in a home. An automatic pressure sensor keeps the system pressurized. If the system has been recently filled or has not been used for an extended period, air bubbles may accumulate at the pump and the system may have to be reprimed.

Whenever the boat is left unattended, the Fresh Water Pump switch should be off.

CAUTION

DO NOT ALLOW THE FRESH WATER PUMP TO RUN DRY. THE FRESH WATER PUMP WORKS ON DEMAND AND WILL NOT SHUT OFF AUTOMATICALLY WHEN THE TANK IS EMPTY. THIS CAN RESULT IN DAMAGE TO THE PUMP. ALWAYS TURN THE FRESH WATER SWITCH OFF WHEN THE FRESH WATER SYSTEM IS NOT IN USE.

Mezzanine Sink

The sink in the mezzanine is supplied by the fresh water system. The faucet pivots and folds down to allow the hatch to close. To use the sink, remove the hatch and rotate the faucet outlet up. Make sure the Fresh Water Pump switch is on. Open the freshwater faucet to supply fresh water to the sink.

Fresh Water System

Cockpit and Head Compartment Shower Operation

There is a shower spray head located in the head compartment and in a receiver on the port side of the mezzanine. The shower in the head compartment has hot and cold water. The retractable shower head in the cockpit mezzanine is cold water only with an ON/OFF valve.

Cockpit Shower

To use the cockpit shower, pull the spray head out of the recess and make sure the Fresh Water Pump switch is on. Activate the shower using the thumb activated valve on the spray head.

Head Compartment Shower

The head compartment shower is equipped with a T handle control. Left to right movement controls water flow and rotating clockwise or counter clockwise controls temperature mixture.

To use the shower, make sure the Fresh Water Pump switch is on. Turn on the shower faucet and adjust the hot and cold water until the desired temperature is obtained. Some minor variations in the water temperature may occur as the pressure pump cycles.

Shower and sink water is drained overboard by the cabin drain sump pump. The pump is controlled by an automatic switch in the sump that is activated whenever the house batteries are connected. The Shower Pump switch in the helm digital switch panel overrides the automatic switch and provides a means to activate the shower sump pump manually. After showering, let the cold water flow for a period of time to flush the drainage system of soap residue.

The cabin drain and shower sump system is located in the forward bilge, below the cabin sole. It is essential that the drain pump strainer is cleaned regularly to remove accumulated debris that will clog the shower drain system.



Cockpit Fresh Water Shower in Mezzanine



Head Compartment Shower & Light



Shower T Handle Control

Fresh Water System

Fresh Water Washdown

Quick-release fresh water washdown hose connectors are located on the side of the cockpit and in the anchor winch compartment. Each connector has an automatic valve that is always closed until the washdown hose is connected. The hose requires a special fitting that snaps into the connector and activates the automatic valve. The cover on the connector should always be closed to keep the connector clean when the washdown hose is not attached. Contact your dealer for information on replacement fittings and hoses.

Make sure the Fresh Water Pump switch is on before using the washdown hose.



Fresh Water Washdown Quick Connection

7.3 Water Heater

The water heater is located in a compartment below the head compartment sink. The 120 volt AC element that heats the water is thermostatically controlled at the heater and activated by a circuit breaker located in the AC panel. A high pressure relief valve protects the system from excessive pressure. To avoid damage to the water heater, always make sure all air is purged from the water heater and lines before activating the water heater breaker. Refer to the water heater owner's manual for additional information.

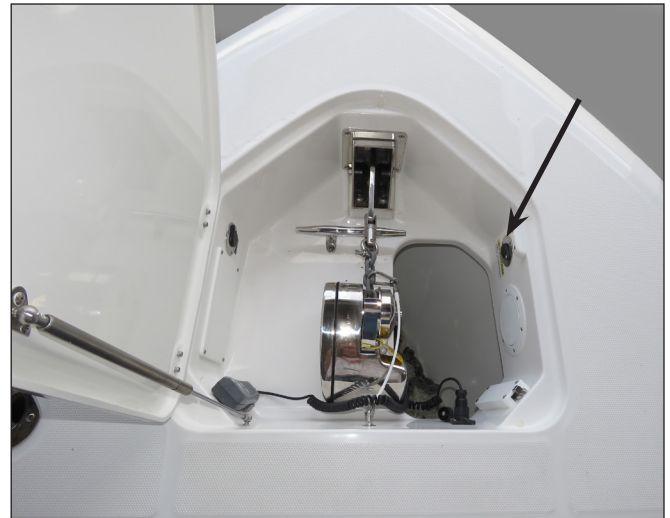

Fresh Water Washdown Connector in Winch Compartment

	CAUTION	
DO NOT SUPPLY CURRENT TO AN EMPTY WATER HEATER. DAMAGE TO THE HEATER WILL RESULT. THE SYSTEM MUST BE FILLED AND PRIMED BEFORE USING THE WATER HEATER.		

7.4 Fresh Water System Maintenance

Information supplied with water system components by the equipment manufacturers is included with this manual. Refer to this information for additional operation and service data.

Routine Maintenance

The following items should be done routinely to maintain your fresh water system:

- Periodically remove and clean the water strainer located near the intake side of the fresh water pump. To clean the strainer, make sure the Fresh Water Pump switch is off. Rotate the strainer bowl counterclockwise to release it. Remove and clean the screen with fresh water. Lubricate the O-ring lightly with Teflon or silicone grease and reinstall the strainer bowl.



Fresh Water Pump & Strainer

Fresh Water System

- Remove the filter screens from faucet spouts and eliminate any accumulation of debris. A build up of debris can cause the pump to cycle excessively.
- Periodically remove the lid on the cabin drain and shower sump and clean the water strainer for the sump pump and the sump.
- Periodically spray the fresh water pump and metal components with a metal protectant.
- The batteries must be properly maintained and charged. Operating the pressure pump from a battery with a low charge could lead to pump failure.
- Add a commercially available potable water conditioner to the water tank to keep it fresh.

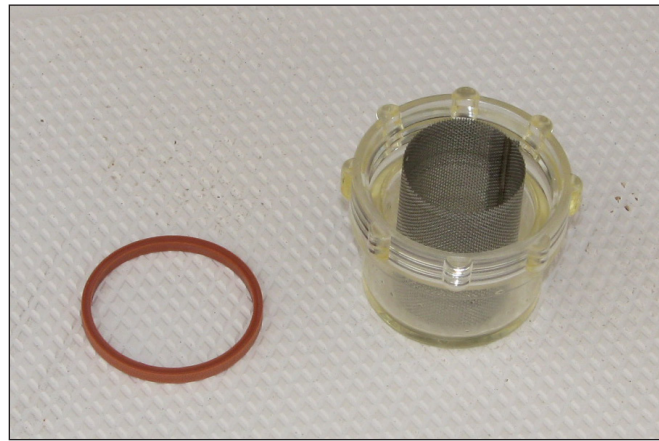

Typical Fresh Water Pump Strainer Removed for Cleaning

Notice:

The fresh water system must be properly winterized prior to winter lay-up. Refer to the section on winterizing for more information.



CAUTION



THE FRESH WATER PUMP SWITCH SHOULD BE PLACED IN THE OFF POSITION WHENEVER LEAVING THE BOAT UNATTENDED OR WHEN THE FRESH WATER SYSTEM IS NOT IN USE.

Sanitizing the Fresh Water Tank

The fresh water system should be sanitized if it has not been used for a long period or you are unsure of the quality of the water in the system.

The following steps can be used to sanitize the system:

- Activate the system, open all faucets and pump out as much water as you can.
- Make a chlorine solution by mixing two ounces of household chlorine bleach in a gallon of water. This mixture will treat approximately fifteen gallons. If the water tank on your boat is larger or smaller than 15 gallons, then adjust the mixture accordingly. Always mix the chlorine with water in a separate container first and never add straight chlorine to the fresh water tank.

- Fill the water tank half full with fresh water and pour the mixture into the water tank. Top off the tank.
- Activate the system and allow the water to run for about one minute at each faucet. Let the treated water stand for 4-6 hours.
- Drain the system by pumping it dry and flush with several tank fills of fresh water.
- The system should now be sanitized and can be filled with fresh water. If the chlorine smell is still strong, it should be flushed several more times with fresh water.

Notice:

The quality of the water in marine freshwater systems can be questionable. We recommend that you avoid using the water from the freshwater system for drinking and cooking. You should only use bottled water for these purposes.

RAW WATER SYSTEM

8.1 General

A raw water manifold located in the aft systems compartment bilge supplies seawater to the raw water pumps. The intake for the manifold is equipped with a ball valve that turns the raw water main supply to the manifold on or off. Other ball valves on the manifold enable the operator to turn the water supply on or off for each individual pump in the system. Always make sure all valves are open before attempting to operate any component of the raw water system.

Priming the System

Make sure the ball valves are open and the Saltwater Pump switch is on. Run the pressure pump by turning on the raw water washdown hose until all of the air is purged from the system and then turn the hoses off. Turn both Livewell Pump switches on and run the pumps until all of the air is purged from the both systems and turn the pumps off.

The intake for the raw water manifold is equipped with a scoop and ball valve. If a pump runs but will not prime make sure the valve is open. If the pump still won't prime, it may be air locked. Make sure the valve is open and run the boat at or above 15 M.P.H. The water pressure from the scoop will force the trapped air through the pump and allow it to prime. If this procedure doesn't work, contact your Everglades dealer.

Closing the thru-hull valves before the boat is hauled from the water will help to eliminate air locks in raw water systems. The valves should also be closed whenever you leave the boat in the water unattended.

Notice:

It may be necessary to reprime the raw water system if it is not used for an extended period and at the time of launching.

8.2 Raw Water System Operation

A high pressure pump, controlled by a pressure sensor, is activated by the Saltwater Pump switch. When activated, the pressure switch will automatically control the pump that supplies the raw water hose connectors.



Raw Water Manifold, Port & Starboard Livewell Pumps, Raw Water Pump Connection, HVAC & SeaKeeper Pump Connections & Ball Valves



Raw Water Pressure Pump & Sea Strainer

As the pressure builds in the system, the pump will shut off. When the system is in use and the pressure drops, the pump will turn on. The water pump is equipped with a strainer on the intake side of the pump. The strainer should be checked frequently and cleaned as necessary.

Whenever the boat is left unattended, the Saltwater Pump switch should be turned off.

Raw Water System

Washdown Hose Connectors

There are two raw water washdown hose connections. One is located on the side of the cockpit below the gunnel and the other is in the windlass compartment at the bow. Each connector has an automatic valve that is always closed until the washdown hose is connected. The hose requires a special fitting that snaps into the connector and activates the automatic valve. The cover on the connector should always be closed to keep the connector clean when the washdown hose is not attached. Contact your dealer for information on replacement fittings and hoses.

Make sure the Saltwater Pump switch is on before using the washdown hose and that the washdown hose spray nozzles are off when the water system is activated.

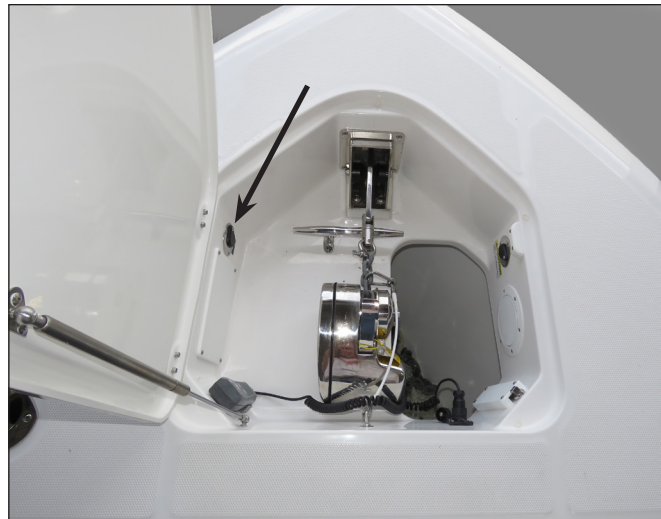

Windlass Raw Water Washdown Hose Connection

CAUTION

DO NOT ALLOW THE WATER PUMP TO RUN DRY. THE PUMP WORKS ON DEMAND AND WILL NOT SHUT OFF AUTOMATICALLY IF NO WATER IS AVAILABLE. THIS CAN RESULT IN DAMAGE TO THE PUMP. ALWAYS TURN THE SALTWATER PUMP SWITCH OFF WHEN THE RAW WATER SYSTEM IS NOT IN USE.

8.3 Livewells

Seawater is provided to each livewell by a 12 volt circulation pump. These pumps are designed to carry a constant flow of water to each well. The pumps do not have a pressure sensor and are activated by the Livewell Pump switches. There is also a light in each well that is activated by the Livewell Light switches.

An overflow built into the drain system automatically controls the water level in each well. Always turn the pumps off when the wells are not in use.

To fill the livewells, insert the plug into the drain fitting at the bottom of each well. Make sure the ball valves on the manifold for each pump and the supply valves in the well are open. Then activate the pump. When the water level reaches the overflow, it will begin to circulate.

The raw water manifold intake is equipped with a high speed pickup that will supply water to the either livewell if the supply pump should fail and helps prime the system during normal operation. To supply water to either well using the high speed pickup, make sure the ball valves on the manifold



Livewell Pumps & Ball Valves

are open and run the boat at a speed above 15 miles per hour. Water will circulate through the well and out the overflow.

To drain the wells, turn off the pumps and remove the plug in the drain fittings. When the well has completely drained, use the washdown hose to flush the well and drain of debris. There is a hook on the side of each well for the drain plug when the well is not in use.

The ball valve at the pumps should be closed whenever the wells are not in use. This will prevent water from entering the well while the boat is cruising.

Raw Water System

Notice:

Do not use the livewells as a dry storage area when they are not in use. Seawater could accidentally be delivered to the well from the thru-hull fitting and damage equipment stored there.

CAUTION

A RUPTURED RAW WATER INTAKE OR PRESSURE LINE COULD CAUSE THE BOAT TO TAKE ON WATER. ALWAYS TURN THE RAW WATER SYSTEMS OFF AND CLOSE THE THRU-VALVES WHEN LEAVING THE BOAT UNATTENDED.

8.4 Livewell Y-Valves

A Y-valve connected to the supply hoses for each livewell is used to provide water flow to one or both livewells. When the livewell pumps are operating properly, the Y-valve is set to the respective livewell. This is considered the normal setting.

If a livewell pump fails, the other livewell Y-valve can be set to supply the well with the failed pump. On this setting the pump will supply only the livewell with the failed pump and no water will be sent to the other well. Setting the Y-valve to "BOTH" will supply both livewells simultaneously. Since the flow to the livewells will be significantly reduced when "BOTH" is selected, this setting should only be used in the event that a livewell pump fails while both tanks are in use.

8.5 Air Conditioning Pump

The air conditioning units are self-contained and seawater cooled. A 120 volt AC centrifugal pump supplies seawater that cools the condensing units as it circulates through the system and is discharged overboard. The Seawater Pump for the air conditioner is located in the aft systems compartment. It must be activated by the HVAC Pump circuit breaker in the cabin AC electrical panel whenever an air conditioner is running.

Seawater is supplied to the pump by a ball valve and hose connected to the raw water manifold. A sea strainer between the pump and ball valve on the manifold protects the system from contaminants that could damage the pump or the air conditioning system. Make sure the pump receives adequate seawater by periodically cleaning the sea strainer basket. Refer to Raw Water System

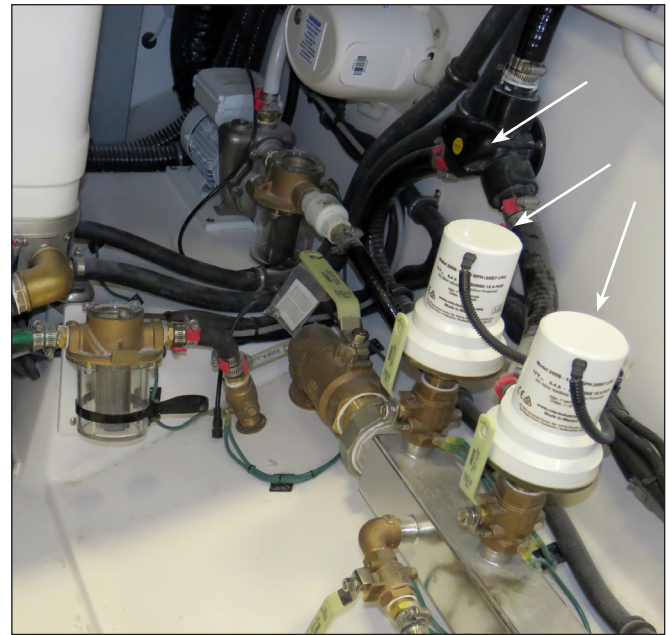

Livewell Pumps & Y-Valve



Air Conditioning Pump & Sea Strainer

Maintenance in this chapter for information on cleaning the sea strainer.

You should refer to the air conditioner owner's manual for more information on the operation and maintenance of the Seawater Pump.

Raw Water System

8.6 SeaKeeper Cooling Pump

The SeaKeeper boat stabilizer is self-contained and seawater cooled. A 12 volt DC pump supplies seawater that cools specific components in the gyroscope system. The pump is located in the aft systems compartment. It is protected and supplied current by a circuit breaker in the battery switch panel. The pump is activated automatically whenever the SeaKeeper system is running.

Seawater is supplied to the pump by a ball valve and hose connected to the raw water manifold. A sea strainer between the pump and ball valve on the manifold protects the system from contaminants that could damage the pump or the cooling system. Make sure the pump receives adequate seawater by periodically cleaning the sea strainer basket. Refer to Raw Water System Maintenance in this chapter for information on cleaning the sea strainer.

You should refer to the SeaKeeper owner's manual for more information on the operation and maintenance of the SeaKeeper cooling system and seawater cooling pump.

8.7 Generator Raw Water Supply

The generator engine uses a closed cooling system with a seawater cooled heat exchanger. Seawater circulates through the heat exchanger and is expelled through the generator exhaust system, cooling it as well. It includes a strainer that prevents debris in the seawater from entering the cooling pump. The strainer is located in the aft systems compartment bilge and supplied seawater by a dedicated thru-hull fitting and sea-cock valve near the strainer. It is important to check and clean the strainer regularly to ensure the seawater system can circulate enough water to cool the heat exchanger and exhaust system on the generator. Refer to Raw Water System Maintenance in this chapter for information on cleaning the sea strainer.

You should also read the generator owner's manual for detailed information on the safe operation and maintenance of the generator.



SeaKeeper System Sea Strainer



Typical Generator Raw Water Seacock & Strainer



Raw Water System

8.8 Raw Water System Maintenance

The following items should be done routinely to help maintain your raw water system:

Routine Maintenance

- Check hoses, particularly the seawater supply lines, for signs of deterioration. Tighten fittings and clamps or replace deteriorated hoses and components as necessary.
- Periodically remove and clean the water strainer located near the intake side of the washdown pump. To clean the strainer, make sure the Saltwater Pump switch is off and close the valve at the raw water manifold. Rotate the strainer bowl counterclockwise to release it. Remove and clean the screen with fresh water. Lubricate the O-ring lightly with silicon or Teflon grease and reinstall the strainer bowl.
- Spray pumps and thru-hull valves with a protective oil periodically.
- The fishboxes and livewells should be drained and cleaned after each use.
- Operate all valves at least once a month to keep them operating properly.

	CAUTION	
<p>SHOULD A HOSE RUPTURE, TURN THE PUMP OFF IMMEDIATELY. ALWAYS CLOSE THE THRU-HULL VALVE WHEN PERFORMING MAINTENANCE ON A SALTWATER PUMP.</p>		
<p>THE BATTERIES MUST BE PROPERLY CHARGED. OPERATING ANY PUMPS FROM A BATTERY WITH A LOW CHARGE MAY LEAD TO A PUMP FAILURE.</p>		
<p>THE RAW WATER SYSTEM MUST BE PROPERLY WINTERIZED PRIOR TO WINTER LAY-UP. SEE SECTION ON WINTERIZING.</p>		

Cleaning the Generator Sea Strainers

Periodically clean the generator sea strainer using the following procedure.

- Turn off the generator.
- Close the generator intake water seacock.
- Rotate the strainer cap counterclockwise to release it. Remove the cap and pull the screen out.
- Thoroughly flush the screen and the inside of the strainer to remove foreign matter.

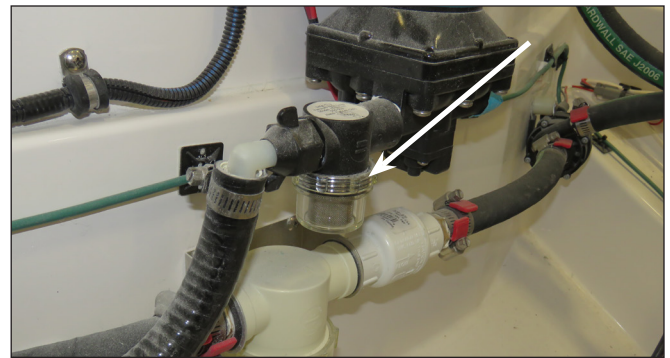

Raw Water Pump Strainer



Typical Raw Water Pump Strainer Removed for Cleaning



Generator Sea Strainer & Seacock

- Lubricate the seal with silicon or Teflon grease and reassemble the strainer, making sure that the strainer cap is tightened hand tight.
- Open the seacock and check for leaks.
- Start the generator and inspect the strainer for leaks and proper water flow at the exhaust port. If there is no discharge within thirty seconds, shut down the generator and find and correct the problem.

Raw Water System

Cleaning the SeaKeeper Pump Strainer

Periodically clean the SeaKeeper pump sea strainer using the following procedure.

- Turn off the SeaKeeper and deactivate the SeaKeeper circuit breaker on the battery switch panel.
- Close the intake valve at the raw water manifold.
- Turn the strainer bowl counterclockwise to remove it and remove the screen.
- Thoroughly flush the screen and the inside of the strainer bowl to remove foreign matter.
- Lubricate the seal.
- Reassemble the strainer making sure that the bowl is tight.
- Open the intake valve, activate the SeaKeeper and check for leaks and proper water flow.



SeaKeeper Pump Sea Strainer

Cleaning the Air Conditioner Pump Strainer

Periodically clean the air conditioner pump sea strainer using the following procedure.

- Turn off the air conditioners and deactivate the HVAC unit and HVAC PUMP circuit breakers on the cabin AC panel.
- Close the intake valve at the raw water manifold.
- Turn the strainer bowl counterclockwise to remove it and remove the screen.
- Thoroughly flush the screen and the inside of the strainer bowl to remove foreign matter.
- Lubricate the seal.
- Reassemble the strainer making sure that the bowl is tight.
- Open the seawater supply valve and check for leaks.
- Activate the air conditioners and monitor the flow of water out of the air conditioner thru-hull fitting in the hull side. If no water is flowing after 30 seconds, shutdown the air conditioner and find and correct the problem.

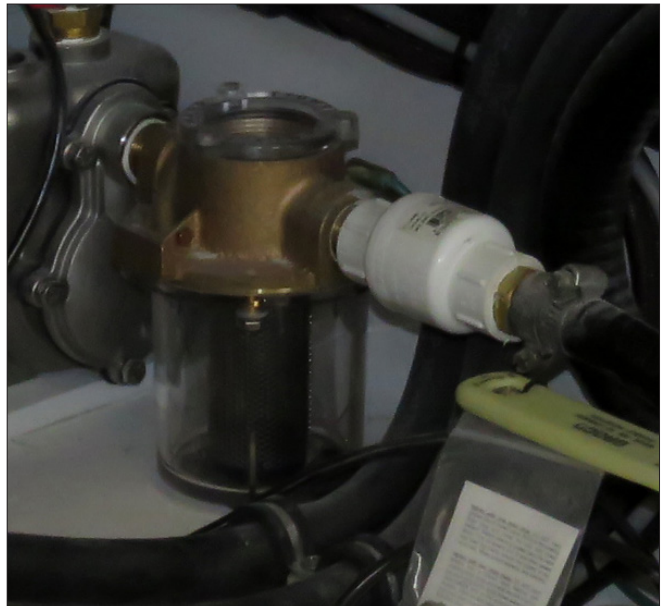

Air Conditioner Pump Strainer

Chapter 9:

DRAINAGE SYSTEMS

9.1 General

Most water is drained by gravity to overboard thru-hull fittings located in the hull above the water line. It is important to check the drain system frequently to ensure it is free flowing and that the hoses on the thru-hull fittings are secure and not leaking.

9.2 Cockpit & Deck Drainage

Cockpit Scupper Drains

Your Everglades has two scupper drains located in the rear of the cockpit. Stainless steel strainers prevent large debris from clogging the drains. Check valves in each scupper drain thru-hull fitting reduce the surge of seawater through the scuppers and into the cockpit while maneuvering or in rough water.

Water is channeled away from all hatches by a gutter or drain rail system. The water then drains overboard through the scupper drain system.

Aft Bait Freezer/Fishbox

The aft Freezer/fishbox drains by gravity to a thru-hull fitting in the hull side.

Baitwells

The baitwells are drained by gravity to thru-hull fittings in the hull sides. The overflows drain to the baitwell drain systems.

Mezzanine Sink

The mezzanine sink is drained by gravity to a thru-hull fitting in the hull side.

Cup Holders

All cup holders in the helm and cockpit areas drain by gravity to the cockpit sole.

Bow Storage Compartment/Cooler

The storage compartments/coolers below the port and starboard bow seats are drained overboard by gravity to thru-hull fittings in the hull sides. Drain plugs for each compartment drain fitting are used to control drainage when the compartments are used as coolers and to prevent seawater from entering the compartments when they are used for dry storage.



Typical Scupper Drains & Drain Rail

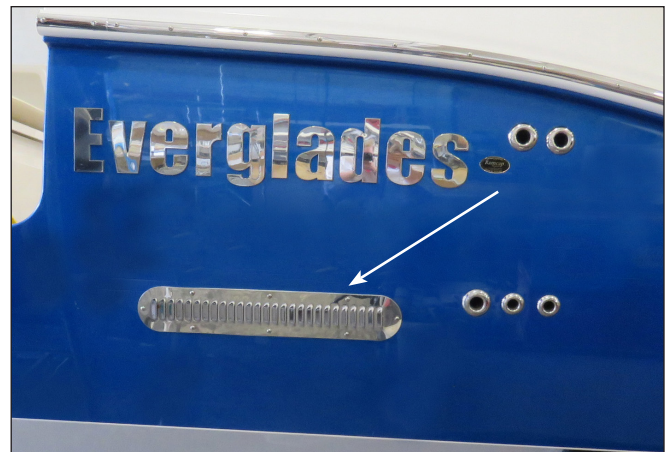

Hull Side Scupper Drain Thru-hull Grate



Bow Storage Compartment Drain & Drain Plug

Drainage Systems

Forward Cockpit Fishbox

The forward storage compartment below the cockpit sole is drained overboard by diaphragm pump in the forward bilge below the berth in the cabin. The pump out system is activated by the Fish Box switch in the helm switch panel.

Monitor the water level as the pump drains the fishbox and turn it off immediately when draining is complete. The pump could be damaged if it is allowed to run dry for extended periods.

The hatch drain rail drains by gravity to a thru-hull fitting in the hull side.

Rod Lockers

The rod lockers on each side of the cockpit drain by gravity to the cockpit sole.

Rope Locker

The rope locker drains overboard thru a drain in the bottom of the locker and a thru-hull fitting in the hull side near the bow. It is important to inspect the drain frequently to remove any accumulated debris.

Console Lounge Storage Compartment/ Cooler

The forward storage compartment below the console lounge seats is drained by gravity to the cockpit through a fitting in the side of the seat base.

Cockpit Air Conditioner

The air conditioning condensation pan is drained by a hose attached to the pan that drains the water to the drain sump system.



Forward Cockpit Fishbox



Rope Locker Drain Fitting in Hull Side

9.3 Hardtop & Tower Drains

There is a hole drilled in the leg bases on the frame to prevent water from being trapped within the legs. Additional drain holes are drilled in the tubing to drain other areas as required.

Always make sure the leg drain holes are clear when the boat is laid up for the winter. Water trapped inside the legs could freeze and cause the legs to split.

Drainage Systems

9.4 Bilge Drainage

The bilge pumps are activated both manually by switches in the helm switch panel and automatically by switches near each pump in the bilge. The automatic switches remain activated when the battery switches are off and the house batteries are connected. All bilge pumps pump water out of thru-hull fittings located above the waterline in the hull.

Notice:

See Electrical Systems for additional information on bilge pump operation.

Bilge High Water Alarm

An additional automatic switch will sound an alarm if the bilge water level rises above the normal operating range of the bilge pump automatic switches. The alarm switch is connected to the batteries. It remains activated when the battery switches are off and the batteries are connected.

When the boat is out of the water the bilge can be drained by a garboard drain located in the transom near the bottom of the hull. The plug should be removed whenever the boat is hauled out of the water and installed just prior to launching. It is important to check the drain plug regularly to make sure it is tight.

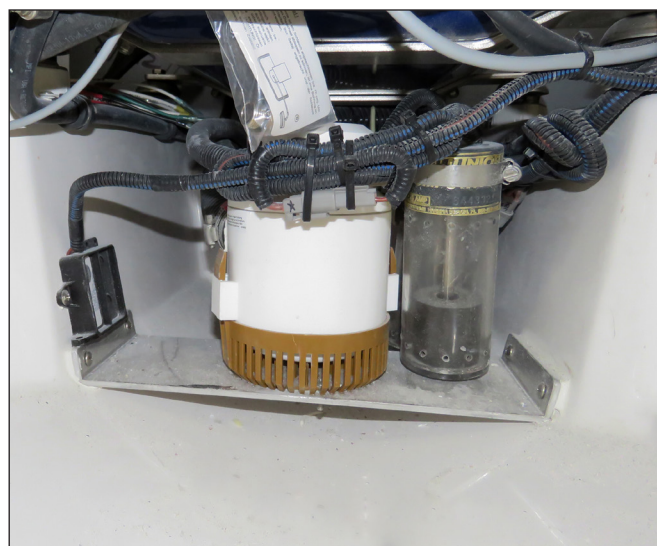

Stern Bilge Pumps & Automatic Switches



Typical High Water Alarm Automatic Switch & Test Recesses

CAUTION

A LOOSE DRAIN PLUG WILL ALLOW SEAWATER TO ENTER THE BILGE AND COULD CAUSE THE BOAT TO TAKE ON ENOUGH WATER TO DAMAGE EQUIPMENT OR ENDANGER THE CREW. IT IS VERY IMPORTANT TO CHECK THE DRAIN PLUG FREQUENTLY TO ENSURE IT IS PROPERLY TIGHTENED.

Important:

Any oil spilled in the bilge must be thoroughly removed and properly disposed of before operating the bilge pump. The discharge of oil from the bilge is illegal and subject to a fine.

CAUTION

THE FEDERAL WATER POLLUTION CONTROL ACT PROHIBITS THE DISCHARGE OF OIL OR OILY WASTE INTO OR UPON THE NAVIGABLE WATERS OF THE UNITED STATES OR THE WATERS OF THE CONTIGUOUS ZONE IF SUCH DISCHARGE CAUSES A FILM OR SHEEN UPON OR A DISCOLORATION OF THE SURFACE OF THE WATER OR CAUSES A SLUDGE OR EMULSION BENEATH THE SURFACE OF THE WATER. VIOLATORS ARE SUBJECT TO A PENALTY OF \$10,000.

Drainage Systems

9.5 Cabin Drainage

Shower and Cabin Drain Sump Pump

The sump system is located in the forward bilge below a hatch in the cabin sole. It is equipped with a strainer, centrifugal pump and automatic switch.

The system is activated whenever the house batteries are connected. The Sump Pump switch in the helm switch panel overrides the automatic switch and provides a means to manually activate the sump pump. Always make sure the House battery switch is activated before using the shower or cabin sinks.

After showering, it is important to let the cold water flow for a period of time to flush the drainage system of soap residue. Make sure to inspect the sump system regularly and keep the sump components and pump strainer clean.

Head Compartment Sink

The head compartment sink drains by gravity to the cabin drain sump pump system.

Cabin Sole

The cabin sole drains by gravity to the bilge through the bilge access hatch in the cabin sole.

Air Conditioner

The cabin air conditioning condensation pan is drained by a hose attached to the pan that drains the water to the cabin drain sump system.

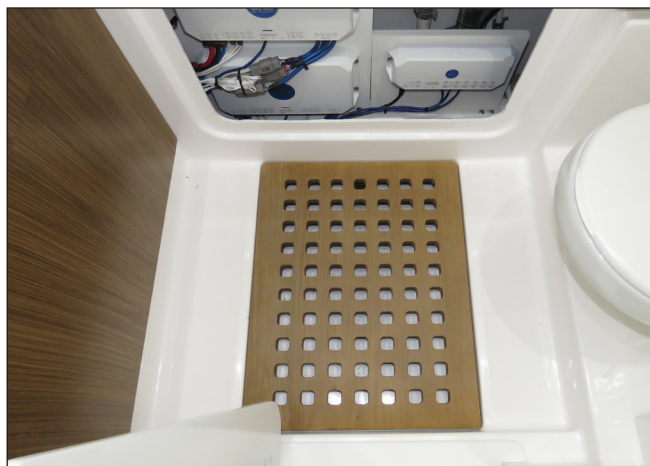

Head Compartment/Shower Drain



Removable Cabin Floor Panel & Cabin Drain Sump System

9.6 Drainage System Maintenance

It is essential that the following items be done periodically to maintain proper drainage of your boat:

- Clean the cockpit drain rails with a hose to remove debris that can block water drainage.
- Clean the hardtop and tower leg drain holes. This is especially important just before winter lay-up.
- Clean the bilge pump strainers of debris and check the bilge for foreign material that can cause the automatic switch to malfunction.
- Frequently test the automatic bilge pump switches for proper operation. This is accomplished by using a garden hose to flood the bilge until the water level is high enough to activate the pump.
- Frequently test the high water alarm automatic switch for proper operation. This is accomplished by simultaneously holding your fingers on the two recesses on the side of the switch until the alarm is activated.
- Clean and inspect the shower and cabin drain sump system. Remove accumulated debris and flush with fresh water. Frequently test the automatic pump switch for proper operation.

- Flush all gravity drains with fresh water to keep them clean and free flowing.
- Flush the air conditioner condensation pans and drain hoses with fresh water at least once each season to remove mold and debris. This is particularly important because mold tends to accumulate in condensation pan drain and, if it is not cleaned regularly, the drain can clog and flood the cabin sole when the air conditioner is operating.
- Clean and flush the fishbox, baitwells, coolers and storage boxes with soap or a bilge cleaner and fresh water after each use to keep them clean and fresh.
- Operate all seacock valves at least once a month to keep them operating properly.

Notice:

All drains and pumps must be properly winterized before winter lay-up.

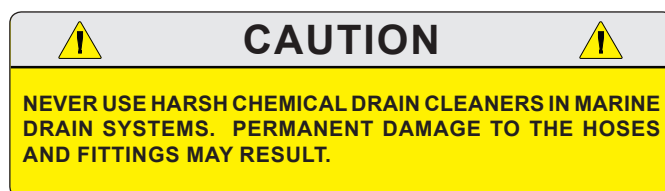

NOTES

VENTILATION SYSTEM

10.1 Cabin Ventilation

Cabin Door

Ventilation to the cabin is provided by opening the cabin door and windows. The door is held in the open position by a spring loaded, automatic latch. Make sure the door is fully latched in the closed position before operating the boat above idle speed.

Port Windows

Opening port windows are located on each side of the cabin. The windows are equipped with a screen and secured in the closed position by three twist action locks. The locks should be adjusted so they are tight enough to seal the window in the closed position, but not so tight that they break the plastic.

Always make sure the windows are closed and secured with the cam levers whenever the boat is underway. Sea spray could enter the cabin through an open window and damage equipment or items stowed there.



Cabin Compartment Door & Port Window



Typical Cabin Port Window

Ventilation System

10.2 Windshield/Helm Compartment Ventilation

The windshield can be lowered to provide ventilation at the helm and improved visibility. The windshield is raised and lowered by hydraulic cylinders activated by an electric hydraulic pump in the cabin bilge below the berth. The system is controlled by the WINDSHIELD UP/DOWN switch in the helm switch panel and touch screen display.



To lower the windshield, press and hold the switch in the down position until the windshield is lowered to the desired position, then release the switch. To close the windshield, hold the switch in the up position until the windshield is completely closed. Always release the switch immediately when windshield reaches the full down or full up position.

A limit switch in the slide track prevents the windshield wiper from operating while the windshield is lowered. Always make sure the windshield is in the full up position before attempting to use the wiper.



Windshield In The Closed Position

10.3 Carbon Monoxide & Proper Ventilation

	DANGER	
<p>FAILURE TO PROPERLY VENTILATE THE BOAT WHILE THE ENGINES OR GENERATOR ARE RUNNING MAY PERMIT CARBON MONOXIDE TO ACCUMULATE WITHIN THE CABIN AND OPEN AREAS OF YOUR BOAT. CARBON MONOXIDE IS A COLORLESS AND ODORLESS GAS THAT IS LETHAL WHEN INHALED. CARE MUST BE TAKEN TO PROPERLY VENTILATE THE BOAT AND TO AVOID CARBON MONOXIDE FROM ACCUMULATING IN THE BOAT WHENEVER AN ENGINE IS RUNNING.</p>		

A by-product of combustion, carbon monoxide (CO) is invisible, tasteless, odorless and is produced by all engines and gas heating and cooking appliances. The most common sources of CO on boats are gasoline engines, auxiliary generators and propane or butane stoves. These produce large amounts of CO and should never be operated while sleeping. The hazard also may be created by a boat nearby whose exhaust fumes are entering your boat. Boats also have a problem due to the "station wagon effect" where engine exhaust fumes are captured in the vacuum or low pressure area, usually the cockpit, bridge deck and cabin, that can be created by the forward speed of the boat.

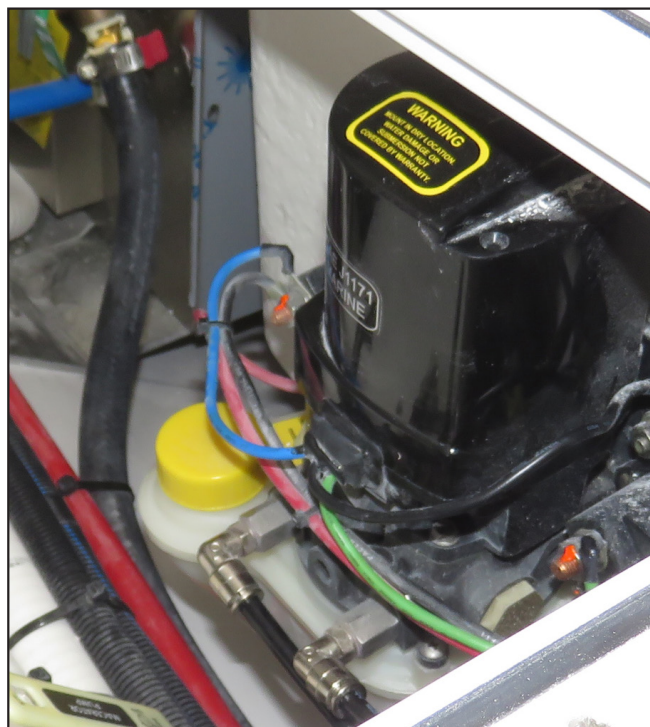

Typical Windshield Hydraulic Pump

Boats underway should close all aft facing hatches and doors. The forward facing deck hatch should be open whenever possible to help pressurize the living spaces of the boat. No sleeping in the cabin should be permitted while underway. Proper ventilation should be maintained at the helm by opening the windshield to help pressurize the area when the enclosure is installed. Canvas drop or aft curtains must be removed to increase air flow and

Ventilation System

maintain proper ventilation whenever the engines are running. ***Under no circumstances should the engines be operating with windshield closed and an aft or drop curtain installed.***

Extreme caution must be taken while at anchor or in a slip when an auxiliary power generator is operating. Wind still nights can easily allow exhaust fumes, containing high concentrations of CO, from the generator on your boat or from an adjacent boat's generator to enter the boat. The exhaust fumes may enter your boat through open hatches or windows.

A carbon monoxide detector has been installed in the cabin as standard equipment. While a CO detector enhances your protection from CO poisoning, it does not guarantee it will not occur. Do not use the carbon monoxide detector as a replacement for ordinary precautions or periodic inspections of equipment. Never rely on alarm systems to save your life, common sense is still prudent and necessary. Remember, the operator of the boat carries the ultimate responsibility to make sure the boat is properly ventilated and the passengers are not exposed to dangerous levels of carbon monoxide. You should always be alert to the symptoms and early warning signs of carbon monoxide poisoning. You should also read the "Carbon Monoxide Monitoring System" in the Safety Equipment chapter of this manual and the owner's manual supplied by the CO detector manufacturer for operation instructions and additional information regarding the hazards and symptoms of carbon monoxide poisoning.

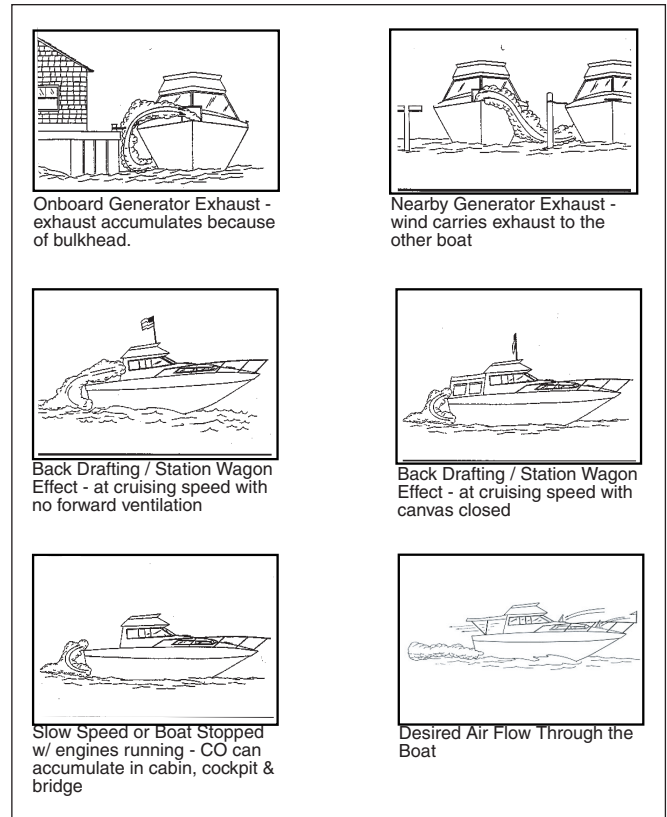

!
DANGER
!

ACTIVATION OF THE CARBON MONOXIDE DETECTOR INDICATES THE PRESENCE OF CARBON MONOXIDE (CO) WHICH CAN BE FATAL. EVACUATE THE CABIN IMMEDIATELY. DO A HEAD COUNT TO CHECK THAT ALL PERSONS ARE ACCOUNTED FOR. DO NOT REENTER THE CABIN UNTIL IT HAS BEEN AIRED OUT AND THE PROBLEM FOUND AND CORRECTED.



Typical Carbon Monoxide Detector & Alarm

Periodically test the carbon monoxide alarm per the manufacturer's instructions. Please refer to the carbon monoxide alarm manual or contact the manufacturer for more information on maintaining and calibrating the alarm.

Ventilation System

10.4 Bilge & Aft systems compartment Ventilation

Ventilation to the bilge and aft systems compartment is provided by vents located on each side of the cockpit liner, below the gunnels and aft of the cockpit near the engines. The ventilation system consists of intake ducts, exhaust ducts and an exhaust blower. The system is designed to meet or exceed the requirements of the United States Coast Guard in effect at the time of manufacture to remove fuel vapors and excess heat from the aft systems compartment while the generator is operating. Additionally, the vents provide air circulation to reduce odors and mildew. Make sure to keep these vents clear and unobstructed.

Free Air System

A flow of air that circulates in and out of the bilge and aft systems compartment is provided by the vents located on either side of the cockpit and two vents just aft of the cockpit near the engines. The pressure differential created at the vents as the wind passes over the cockpit provides adequate air movement while operating at or near cruise speeds.

Forced Ventilation

Your boat is equipped with an electric blower connected to the starboard rear vent near the transom that provides forced ventilation to the aft systems compartment prior to generator start up and while it is operating. The in-line blower is activated by the Blower switch in the cabin and is located in the vent hose near the generator. Refer to the Electrical Systems chapter for more information on generator and blower operation.



Typical Free Air Vent Below Gunnels in Cockpit



Port Bilge & Aft systems compartment Free Air/Forced Air Vent Aft of Cockpit

10.5 Maintenance

- Periodically lubricate all hinges and latch assemblies with a light oil.
- Periodically clean and coat gasket materials with silicone to help keep them pliable.
- The opening port windows are made of acrylic plastic glass. Acrylic glass scratches easily. Never use a dry cloth or glass cleaning solutions on acrylic glass. Use a soft cloth and mild soap and water for routine cleaning. Solvents and products containing ammonia can permanently damage acrylic glass. Please refer to the Routine Maintenance chapter for more information on the proper maintenance for acrylic plastic glass.



Bilge Blower Switch

Ventilation System

- Keep the windshield slide tracks clean. Periodically coating the tracks with silicone spray will reduce friction and keep the windshield sliding smoothly.
- Check the oil level in the windshield hydraulic pump Reservoir frequently. Use only hydraulic oil meeting the pump manufacturer's specifications when adding oil. Refer to the pump manufacturer's operating and information manual for information on the operation and maintenance of the hydraulic system and oil specifications.
- Periodic inspection and cleaning of the bilge and aft systems compartment ventilation ducts is necessary to ensure adequate air circulation. A buildup of leaves, twigs or other debris can severely reduce ventilation.
- The bilge blower is permanently lubricated and requires no maintenance. Blower operation can and should be tested by placing a hand over the exhaust vent. Do not rely on the sound of the blower. A substantial amount of air should be exhausted by the blower. Frequently check the intake vents for obstructions and proper blower operation, preferably before each cruise.

Notice:
Should blower noise become excessive, the source of the noise should be found and corrected before operating the boat.



WARNING



OBSTRUCTING THE VENTILATION SYSTEM WILL RESTRICT AIR IN AND OUT OF THE AFT SYSTEMS COMPARTMENT. THE AIR FLOW THROUGH THE AFT FORCED AIR VENT IS IMPORTANT FOR PROPER AIR FLOW VOLUME WHILE THE GENERATOR IS RUNNING. MAKE SURE THE AIRFLOW OUT OF THIS VENT IS NOT OBSTRUCTED.

NOTES

EXTERIOR EQUIPMENT

11.1 Deck

Rails and Deck Hardware

The rail system and hardware fittings have been selected and installed to perform specific functions. Hand rails are installed to provide a handhold in certain areas of the boat. You should make sure you keep at least one hand on the handholds as you move about the boat.

Fenders or mooring lines should be secured to the cleats and not to rails or stanchions. The cleats on your boat are retractable and flush with the deck when not in use. To use the cleats, pull up on the center of the cleat until it locks in the mooring position.

Be sure a clear lead exists when running dock lines or anchor lines. A line inadvertently run around a stanchion or over the rail could cause damage.

Important:

All fittings must be periodically inspected for loose fit or wear and damage. Any problems should be corrected immediately.



WARNING



EVERGLADES BOATS ARE NOT EQUIPPED WITH HARDWARE DESIGNED FOR TOWING PURPOSES. THE MOORING CLEATS ARE NOT TO BE USED FOR TOWING ANOTHER VESSEL OR HAVING THIS BOAT TOWED.



Retractable Cleat Down



Retractable Cleat Up



Bow Roller & Anchor

11.2 Rope Locker & Windlass

Bow Roller

The bow roller is built into the hull and is equipped with hardware that allows the anchor to be operated and stored at the roller. The roller assembly, windlass, anchor line and chain binder are concealed below a hatch in the deck. The anchor line is stored in the rope locker and routed out the windlass, through the roller and connected to the anchor chain. A chain binder is provided between the windlass and the roller to secure the anchor. Always make sure the anchor is properly secured by the chain binder when it is in the stored position on the roller.

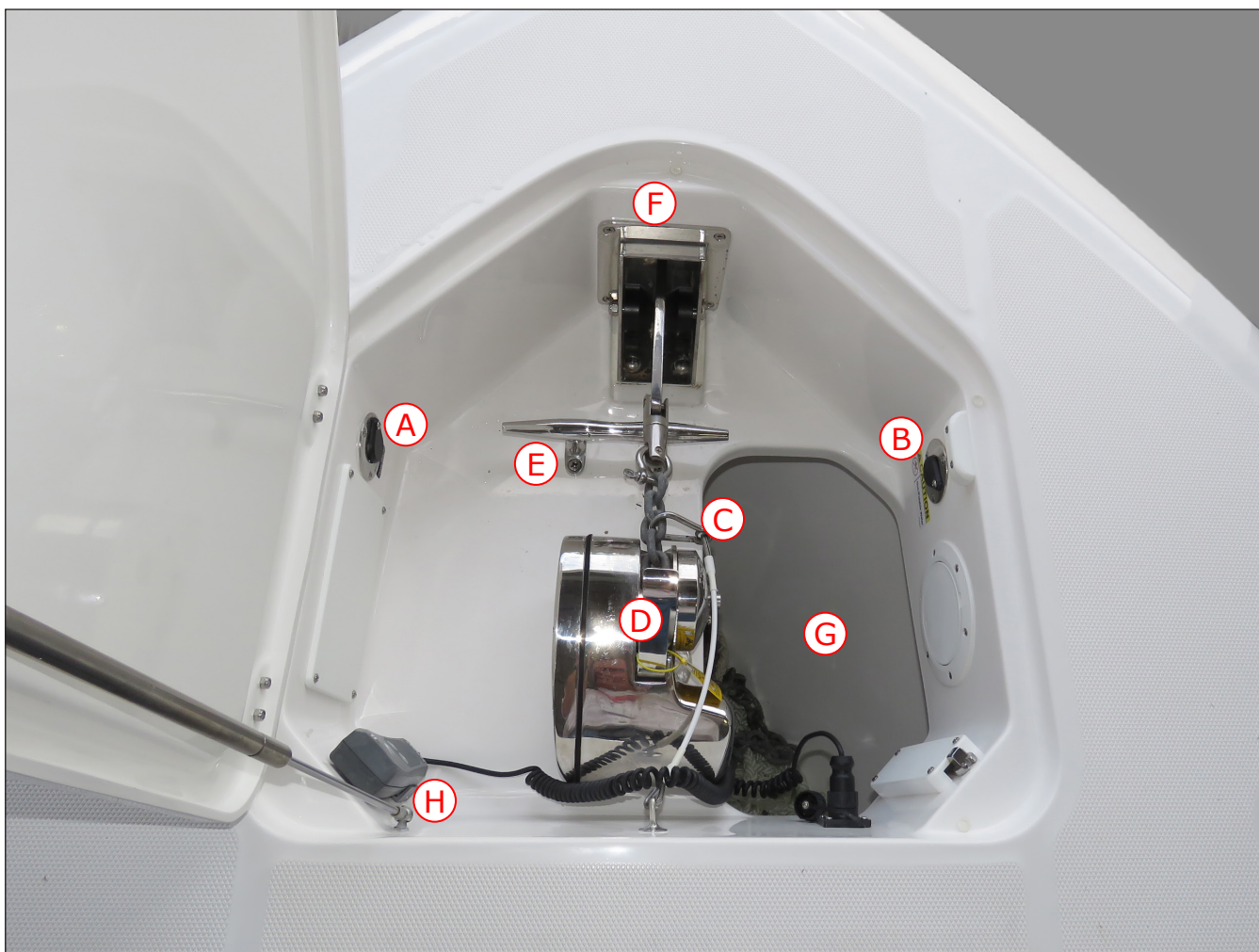

- | | |
|--------------------------------|--------------------------------------|
| A. Raw Water Faucet | E. Anchor Line Cleat |
| B. Fresh Water Washdown Faucet | F. Bow Roller Assembly |
| C. Chain Binder | G. Rope Locker |
| D. Windlass | H. Remote Windlass Switch Connection |

The chain binder is accessed by opening the hatch and is designed to connect to a link in the anchor chain when the anchor is hauled in. To release the binder, pull the anchor chain in slightly to relieve the tension on the binder, then release the binder from the chain. To secure the anchor in the up and stored position, raise the anchor until it seats firmly in the roller with the chain snug. Attach the chain binder to a link in the chain. Before getting underway after hauling the anchor, always make sure the binder is properly attached to the anchor chain link and the hatch is closed and latched.

Rope Locker

The anchor rope locker, windlass and windlass remote switch connector are concealed in a recess below a hatch in the deck. A gas charged spring supports the hatch in the open position. A

flush, "push to close" latch secures the hatch in the closed position. Always make sure the hatch is closed and latched before operating the boat above idle speed.

The rope locker and anchor line is accessed through an opening next to the windlass. The anchor line is always stored in the rope locker and there is an eye fitting to secure the bitter end of the anchor line.

The windlass recess is equipped with faucets plumbed to the fresh and raw water systems to accommodate a washdown hose. After the anchor is hauled in and secured with the chain binder, use the washdown hose to rinse the anchor, chain and hardware. Make sure the Saltwater Pump or Freshwater Pump switch is on before using

Exterior Equipment

the washdown hose. Use the freshwater water washdown when possible to reduce corrosion on the windlass and hardware. Remember to open the hatch and rinse the windlass and all hardware with freshwater when the boat is washed at the end of each day when the raw water washdown has been used to rinse the hardware when the anchor was hauled.

The rope locker is designed for the anchor line and not for storing anchors or additional anchor lines. Do not store anchors or any heavy objects in the locker. Anchors and weights for floating markers will bounce and damage the hull or rope locker if they are stored there. They will also interfere with the operation of the windlass. Always store and secure additional anchors and weights in a storage compartment in the cockpit as far aft as possible.

The rope locker is drained by a fitting in the hull side near the bottom of the locker. It is very important to check the drain frequently to make sure it is clean and free flowing.

Periodically remove the anchor line from the rope locker, rinse it with fresh water and allow it to dry in the sun. Cleaning the anchor line regularly will reduce odors in the rope locker and increase the life of the line.

The line should also be inspected for abrasions or signs of deterioration. Replace the line if it shows any sign of damage or deterioration. It is important to replace the anchor line with a new line of the type recommended or supplied by the windlass manufacturer.

Windlass

The windlass is mounted in the compartment below the hatch in the deck. The anchor is stored on the roller and is raised and lowered by the windlass. The anchor line is stored in the rope locker and routed out through the windlass to the anchor chain.

The anchor is lowered by releasing the anchor chain from the chain binder and pressing the WINDLASS DOWN switch at the helm or on the remote switch. The windlass control switches are protected by a circuit breaker in the digital switch control module.

After the anchor is set, the windlass must not be left to take the entire force from the anchor line. Boats lying to their anchor in a high swell or heavy weather conditions will snub on the line. This can cause slippage or apply excessive loads to the windlass. The line should be made fast to the cleat provided to relieve the load on the windlass.

The anchor is hauled in by releasing the line from the cleat and pressing the WINDLASS UP switch. Always start the engines before hauling the anchor and motor up to the anchor as the line is retrieved to relieve the load on the windlass. Once the anchor is retrieved, independently secure the anchor to the chain binder to prevent it from being accidentally released. This is especially important while the boat is underway.

The windlass manufacturer provides an owner's manual with its product. It is extremely important that you read the manual and become familiar with the proper care and operation of the windlass. Refer to the Operation chapter for tips on anchoring your boat.



WARNING



A WINDLASS MUST BE USED WITH CARE. IT IS EXTREMELY IMPORTANT THAT YOU READ THE OWNER'S MANUAL AND BECOME FAMILIAR WITH THE SAFETY INSTRUCTIONS AND PROPER OPERATION OF THE WINDLASS BEFORE USING IT WITH YOUR BOAT. ALWAYS ENSURE THAT LIMBS, FINGERS, HAIR AND CLOTHING ARE KEPT CLEAR OF THE WINDLASS AND ANCHOR LINE DURING OPERATION.

A PARTIALLY LOWERED AND LOOSE ANCHOR CAN CAUSE CONSIDERABLE DAMAGE TO THE HULL. DO NOT USE A WINDLASS AS A SOLE MEANS OF SECURING AN ANCHOR IN THE BOW ROLLER. ALWAYS SECURE THE ANCHOR TO A CHAIN BINDER BEFORE OPERATING YOUR BOAT.

Exterior Equipment

11.3 Hull

Engine Mounting System

Your Everglades is equipped with an engine mounting system that is integrated into the hull and stringer system that is designed to distribute the stresses of engine weight and thrust throughout the entire hull.

Engine hoses and cables or the transom gel coat can be damaged by tilting the engines to the full up position with the engines turned to the wrong position. You should monitor the engines as they tilt to determine best full tilt engine position for your boat.



A platform built into the engine mounting system with a boarding ladder is standard on your boat.

Stern Boarding Ladder

A telescopic boarding ladder is recessed into the transom below the platform. To use the ladder, turn the steering wheel starboard to move the port engine propeller as far from the ladder as possible. Release the spring loaded retaining pin, pull the ladder out of the recess and rotate it to the down position. Unfold the steps. The ladder must be retracted and secured in the recess before starting the engines.



Engine Mounting System

	WARNING	
<p>MOVING PROPELLERS ARE DANGEROUS. THEY CAN CAUSE DEATH, LOSS OF LIMBS OR OTHER SEVERE INJURY. DO NOT USE THE SWIM PLATFORM OR BOARDING LADDER WHILE AN ENGINE IS RUNNING. STOP THE ENGINES IF DIVERS OR SWIMMERS ARE ATTEMPTING TO BOARD. ALWAYS RETRACT AND PROPERLY SECURE THE LADDER BEFORE STARTING THE ENGINES.</p>		

Unassisted Boarding Situations

When using the stern ladder in an unassisted boarding situation in deep water, release the spring loaded retaining pin. Brace yourself by placing both feet against the transom and pull the ladder out of the recess. Rotate it to the down position and unfold the steps. Use the grab rail, transom eye and ladder to steady yourself while unfolding the steps and boarding. Remember to retract the ladder and secure it in the recess before starting the engines.



Stern Boarding Ladder

Exterior Equipment

Trim Tabs

The trim tab interceptors are mounted to the hull below the transom. The trim tabs are an important part of the control systems. Refer to the Helm Control Systems chapter for detailed information on the operation of the trim tabs.

Underwater Lights

The LED underwater lights are mounted in the transom, below the water line. The lights are activated by the Underwater Light switch at the helm and should only be used when the boat is in the water with the lights submerged.



Underwater Lights

Hull Step Ventilation

Thru-hull fittings in the hull step below the transom are connected to air vent fittings in stern above the splashwell. It is important that these vents are open to eliminate vacuum in the hull step when the boat is running at or above cruise speed. Plugged vents can result in a noticeable loss in speed and efficiency.

Docking Lights (Optional)



Located on each side of the bow. These lights provide lighting forward of the bow while docking or maneuvering in tight quarters at night. They are activated by the DOCKING LIGHTS switch in the helm switch panel and should only be used during docking, mooring or anchoring situations. Never use docking lights while cruising. They are not legal for night navigation and may obstruct the visibility of the bow navigation lights to oncoming vessels.





Heavy Duty Bow Eye

Heavy Duty Bow Eye

The heavy duty bow eye is designed for towing the boat. The eye includes a welded stainless steel plate with internal bow reinforcement and backing plates that distribute the force on the bow eye to a larger area of the hull than with the standard bow eye. This feature allows the boat to be towed behind a larger vessel.

	DANGER	
<p>TOWING A BOAT BEHIND A LARGER VESSEL REQUIRES SPECIAL KNOWLEDGE AND SKILL. THE USE OF TOW LINES OR HARDWARE NOT INTENDED FOR TOWING OR RATED FOR THE FORCES EXERTED ON EQUIPMENT DURING THE TOW IS EXTREMELY DANGEROUS AND CAN CAUSE SEVERE INJURY OR DEATH TO PASSENGERS IF THAT EQUIPMENT FAILS. NEVER TOW THE BOAT BEHIND A LARGER VESSEL USING A TOW LINE, HARNESS OR OTHER EQUIPMENT NOT RATED FOR THE EXPECTED LOADS EXPERIENCED DURING THE TOW. IF YOU ARE NOT EXPERIENCED IN TOWING A VESSEL, CONSULT WITH AN OPERATOR AND A MARINE FACILITY EXPERIENCED IN TOWING VESSELS FOR HELP SELECTING PROPER EQUIPMENT AND FOR TRAINING.</p>		

	CAUTION	
<p>BOATS THAT ARE TOWED BEHIND LARGER VESSELS REQUIRE SPECIAL MAINTENANCE. ATTENTION TO THE ALUMINUM AND STAINLESS STEEL HARDWARE IS ESSENTIAL. SALT SPRAY, SALTY STEAM AND CHEMICALS IN EXHAUST GASES ARE PARTICULARLY CORROSIVE AND WILL DAMAGE THE SURFACE OF STAINLESS HARDWARE OR ANODIZED AND POWDER COATED ALUMINUM. IT IS IMPERATIVE THAT THE BOAT AND HARDWARE ARE CLEANED THOROUGHLY AT THE COMPLETION OF EACH TRIP OR AT THE END OF EACH DAY ON LONG CRUISES TO REDUCE ACCELERATED DETERIORATION AND PREMATURE CORROSION TO ALUMINUM, STAINLESS STEEL AND OTHER COMPONENTS ON THE BOAT.</p>		

Exterior Equipment

11.4 Cockpit Features

General

Most hatches and doors in the cockpit are secured with special cam action, draw or automatic “push to close” latches. Gas charged springs are used on most hatches in the deck and cockpit that help raise the hatches and hold them in the open position.

Some large hatches in the cockpit sole and deck are secured with flush mounted, twist lock latches with handles that store flush to the hatch in the latched position. Always make sure that all hatches are closed with the latches in the secured position before operating the boat above idle speed.



Round access plates located in the sides of the cockpit liner provide access to the fill hoses and fittings. Other access plates in the cockpit sole provide accesses to fuel supply lines, fuel gauge sender and the fuel fill and vent hose connections on the fuel tank.



Twist Latch in Secured Position



Side Boarding Door & Gate

	WARNING	
<p>IN CERTAIN CONDITIONS, OPEN EXTERIOR DOORS AND HATCHES THAT ARE NOT SECURED PROPERLY CAN SLAM CLOSED UNEXPECTEDLY AND CAUSE INJURY TO PASSENGERS OR DAMAGE TO THE BOAT. SOME DOORS AND HATCHES ARE EQUIPPED WITH SPECIAL FASTENERS, HATCH LIFTERS, MAGNETIC LATCHES OR SNAPS AND STRAPS TO SECURE THEM IN THE OPEN POSITION. ALWAYS MAKE SURE THAT THESE HATCHES AND DOORS ARE PROPERLY SECURED WHENEVER THEY ARE IN THE OPEN POSITION.</p>		

Side Boarding Door

A side boarding door and gate is incorporated in the port rear hull side. The door provides divers and swimmers easy, unobstructed access to the water and cockpit. It also makes boarding and exiting the boat much easier in many docking situations.

The gate is hinged and opened by releasing the slide latch at the front of the gate and swinging it aft onto the gunnel. The side door swings inboard when the gate is open. A magnetic latch holds the door in the full open position and a special latch mounted on the inboard side of the door secures it when it is closed. The door latch has a spring loaded safety pin. When the side door is closed, make sure the latch is completely closed and that the safety pin is snapped into place to prevent the latch from opening accidentally.



Side Boarding Door Gate Open



Exterior Equipment

The door sits flush against the cockpit when it is open. The latch must be in the unlatched, vertical position to swing flush against the cockpit.



The side door and gate should only be opened when the boat is not in motion with the engines shutdown. The door must be secured in either the OPEN position with the magnetic latch or in the CLOSED position with the main latch and safety pin. Never leave the side door unlatched.

Notice:

Periodically inspect the door hinges and hardware for wear, damage or loose fit. Any problems found should be corrected immediately.

 **WARNING** 

THE SIDE BOARDING DOOR AND GATE SHOULD BE CLOSED AND PROPERLY LATCHED WHENEVER THE ENGINES ARE RUNNING. NEVER OPEN THE DOOR WHILE UNDERWAY OR IN ROUGH SEA CONDITIONS. IN CERTAIN SITUATIONS, AN OPEN DOOR COULD ALLOW A SUBSTANTIAL AMOUNT OF WATER TO ENTER THE COCKPIT CREATING A POTENTIALLY DANGEROUS CONDITION.

 **WARNING** 

OPERATING THE BOAT UNDER POWER WITH THE SIDE BOARDING DOOR AND GATE OPEN MAY ALLOW PERSONS TO FALL OVERBOARD AND INTO BOAT PROPELLERS OR TO BE LOST IN OPEN WATER. ALWAYS CHECK TO MAKE SURE THE DOOR AND GATE ARE PROPERLY CLOSED AND LATCHED BEFORE STARTING THE ENGINES. NEVER OPERATE THE BOAT UNDER POWER WITH THE SIDE BOARDING DOOR AND GATE OPEN.

Notice:

Periodically inspect the side door hinges and hardware for wear, damage or loose fit. Any problems found should be corrected immediately.

Side Telescopic Boarding Ladder

The side boarding ladder is mounted to special brackets in a storage compartment on the port side of the cockpit when it is stored. To use the ladder, remove it from the storage compartment and slide the studs into the special bracket on the hull side just below the door. Release the strap securing the steps and pull the bottom step to extend the ladder.

The ladder is secured in the bracket by a spring loaded latch that prevents the ladder from sliding off the bracket. To remove the ladder, retract the



Side Door Main Latch & Spring Loaded Safety Pin



Boarding Ladder in Storage Compartment

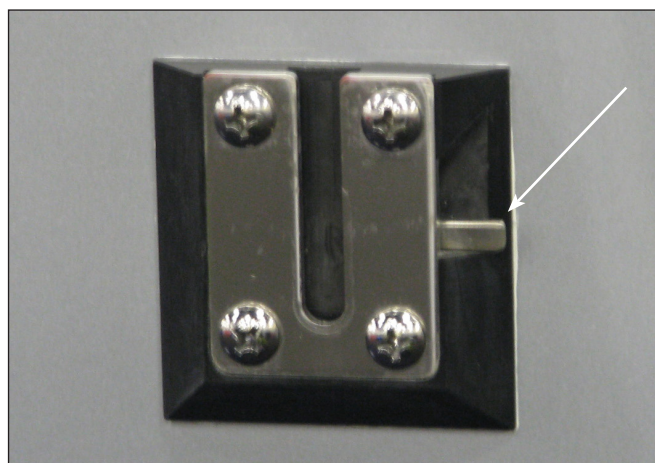

Dive Ladder Bracket & Release Lever

steps and secure them with the strap. Push up on the release lever on the side of the ladder bracket to release the latch, then slide the ladder up and off the bracket.

Exterior Equipment

To prevent damage to the ladder, hull side or bracket, the ladder must be removed from the bracket and properly secured in the cockpit storage compartment before starting the engines.



WARNING



MOVING PROPELLERS ARE DANGEROUS. THEY CAN CAUSE DEATH, LOSS OF LIMBS, OR OTHER SEVERE INJURY. DO NOT USE ANY PLATFORM OR BOARDING LADDER WHILE AN ENGINE IS RUNNING. STOP THE ENGINES IF DIVERS OR SWIMMERS ARE ATTEMPTING TO BOARD. ALWAYS REMOVE ALL LADDERS AND CLOSE THE SIDE DOOR AND GATE BEFORE STARTING THE ENGINES.



Stern Livewells & Freezer/Fishbox

Stern Livewells

The stern livewells are located on each side of the fishbox at the rear of the cockpit. Each livewell is equipped with a hatch that is held open by a lanyard and secured with rotating compression latches with handles that store flush with the hatch when closed.

They are equipped with a light, built in overflow and a backup pump system. The livewells drain by gravity to thru-hull fittings in the hull.

Each livewell is supplied seawater by a dedicated centrifugal raw water pump located in the aft systems compartment. If a livewell pump fails, a Y-valve near the pumps can be used to supply the well from the other pump.

The overflow built into the side of the livewells automatically controls the water level. The livewells should be drained and rinsed clean with fresh water after each use. Refer to the Raw Water System and Drainage Systems chapters for more information on the operation of the livewells.

Notice:

If your boat is equipped with the optional electric grill, there will be one livewell on the port side.

Stern Bait Cooler/Freezer/Fishbox

An insulated cooler/freezer/fishbox is located between the livewells in the rear of the cockpit. The hatch is held open by gas springs and secured with two rotating compression latches with handles that store flush with the hatch when it is closed. The box drains by gravity to a thru-hull fitting in the hull side.



Cutting Board in Fishbox

The fishbox is equipped with a removable cutting board that is mounted on hinges below the hatch. The cutting board can be raised to provide access to the fishbox or lowered to prepare bait.

The optional refrigerator/freezer cooling unit is located below the mezzanine and powered by the AC electrical system. Temperature is controlled by a digital monitor located in the cabin 120 volt panel. Freezer/fishbox temperature is displayed on the LED screen and buttons on the panel allow for the adjustment of the temperature inside each compartment.

Refer to the refrigerator/freezer unit owner's manual for additional information on the operation and maintenance on the refrigerator unit.

Exterior Equipment

Electric Grill (Optional)

An 120 volt electric, stainless steel grill is located on the starboard side of stern fishbox. This option replaces the starboard livewell. It is mounted to a retractable cabinet with a drawer and solid surface countertop. The grill and cabinet are raised and lowered by an electric actuator controlled by a rocker switch on the side of the cockpit near the grill.

The switch is a three position momentary switch. The center position is off. Press and hold the top of the switch to raise the grill. Press and hold the bottom of the switch to lower the grill. The pedestal will stop immediately when the switch is released.

To use the grill, make sure the Cockpit Grill circuit breaker in the AC panel is activated. Open the hatch and use the GRILL UP/DOWN switch to raise the grill and cabinet. Then use the touch control near the grill to activate the burner and control the temperature. After cooking, be sure the burner is turned off and allowed to cool before lowering the grill and closing the hatch. Never lower the grill and close the hatch while the grill is hot. Deactivate the Cockpit Grill circuit breaker whenever the grill is not being used to ensure it is not activated accidentally.

Refer to the grill operating manual for additional information on the proper operation and maintenance of the grill.



Electric Grill & Retractable Cabinet



Grill Touch Control

Exterior Equipment

Aft Cockpit Bench Seat

Your boat is equipped with forward facing bench seats in the rear of the cockpit. Each seat is designed to fold flush against the cockpit when it is not in use.

To use a seat, pull the handle near the top of the seat base out of the recess toward the cockpit. As the seat rotates out, grab the rear and front of the seat cushion and rotate it down to the seat position. The seat automatically stops when the cushion reaches the seating position.

To store the seat, grab the rear and front of the seat cushion and rotate it up until it is almost folded into the recess, then push the seat firmly into the recess. The seat will automatically be secured in the stored position when it is completely folded into the recess.

Aft systems compartment Access

A hatch in the rear of the cockpit provides access to the pumps, strainers, generator, SeaKeeper and other equipment in the aft systems compartment. The stern bilge pumps, raw water supply manifold, livewell supply pumps, air conditioner and raw water pumps are among the equipment in this compartment. The hatch is held open by gas springs and secured with two rotating compression latches with handles that store flush with the hatch when it is closed.

The latches are designed to pull the pawl against cockpit sole slightly when closed, securing the hatch and compressing the gasket for a more watertight seal. Always make sure the hatch is closed with the latches in the secured position and the handles folded flush before operating the boat above idle speed.

To open the hatch, release the latches by pulling the handles out and rotating them until the latch releases. Then lift the hatch to the full open position. Close the hatch by pushing it to the closed position. Then rotate the latch handles until they are latched in the closed position and securing the hatch firmly to the cockpit sole.



Aft Bench Seat Closed



Aft Cockpit Bench Seat Open

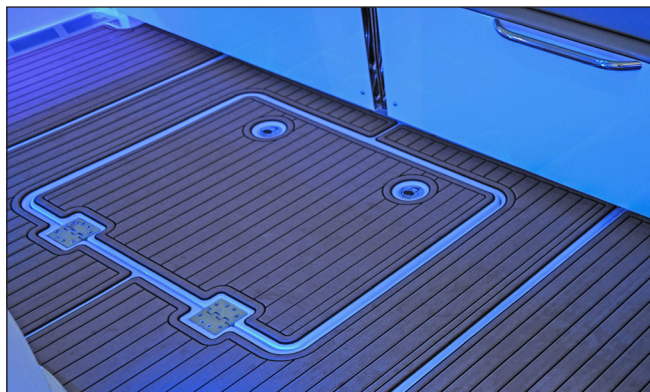

Aft Systems Compartment Hatch

Exterior Equipment

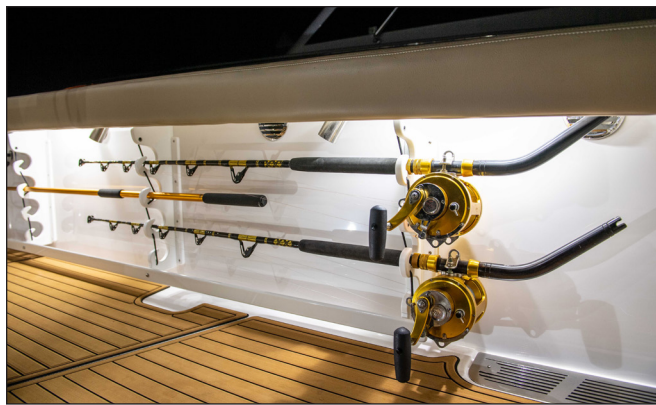

Cockpit Rod Rack



Side Storage Compartment

Rod Racks

There are recessed rod storage racks located below the gunnel on each side of the cockpit. They are equipped with stretch cords to secure the rods to the racks. Always make sure the rods are properly secured in the storage racks with the rod tips forward.

Side Storage/Life Jacket Compartments

There are storage compartments on each side of the cockpit. The compartments are designed to accommodate life jackets or dunnage. Each compartment drains to the bilge and is accessed by a door secured with "push to close" latches.



Mezzanine & Aft Facing Bench Seat

11.5 Mezzanine

A mezzanine equipped with a sink, cooler, shower, waste basket and tackle storage is located aft of the helm seats. The sink faucet on the starboard side folds to allow the hatch to close and is plumbed to the fresh water system. There is a fresh water shower with a removable spray head and built in waste basket on the port side. The sink is drained by gravity to a thru-hull fitting in the hull.

There are tackle drawers with removable tackle trays and storage compartments behind doors on each side of the mezzanine that are equipped. Lockable "Push to close" latches secure each door when they are closed. There are brackets on each door that provide storage for the removable sink and waste basket hatches when they are being used.



Mezzanine Tackle Drawers & Storage Compartments

Aft Facing Bench Seat

A rear facing bench seat is built into the rear of the mezzanine. The bench seat cushion is hinged and raises to provide access to the cooler. Gas charged

springs hold the seat in the open or closed position. Cup holders and USB chargers are located on each side of the seat.

Exterior Equipment

A folding footrest is located on the seat base. Two spring loaded latches on each side of the footrest secure it in the closed position. To use the footrest, slide the latches inboard and rotate the dead bolts up or down to secure in the released position. Then rotate the footrest down. To stow the footrest, rotate it up against the front of the seat base and release the latches. The spring in each latch will automatically slide the bolt and secure the latches. Always make sure the footrest is secured with the latches when it is folded in the stowed position.

If your boat is equipped with the optional upper control station, the footrest, seat and top of the mezzanine are used as steps to access the upper station from the cockpit.



Bench Seat Footrest

Cooler/Freezer

The bench seat cushion is mounted to a hatch that provides access to a large compartment/cooler below the lounge that can be used for dunnage or as a cooler. The compartment drains by gravity to thru-hull fittings in the hull.

The hatch is equipped with gas hatch springs that hold the hatch in the open or closed position. The optional refrigerator/freezer cooling unit is located below the mezzanine and powered by the AC electrical system. Temperature is controlled by a digital monitor located in the cabin 120 volt panel. Temperature is displayed on the LED screen and buttons on the panel allow for the adjustment of the temperature inside each compartment.



Typical Cockpit Air Conditioner Control Panel

Cockpit Air Conditioner (Optional)

The cockpit air conditioning unit and optional refrigeration units are mounted below the mezzanine. The compartment is accessed by removing the storage compartment assemblies on each side of the mezzanine. The air conditioner is powered by the AC electrical system and equipped with reverse cycle heat so it can be operated as a cooling or heating unit.

To operate, make sure the thru-hull valve for the air conditioning raw water supply pump, located in the systems compartment, is on. Turn the HVAC Unit Cockpit and HVAC Pump breakers in the AC breaker on. The air conditioning or heat then will be controlled by the electronic control panel next to the aft facing bench seat. When activated, water should continuously flow from the overboard thru-hull fitting in the hull side.

The air conditioning system produces heat when it is operated in reverse cycle mode. The ability of the

unit to produce heat is affected by the temperature of the seawater. As the seawater temperature lowers, the unit's ability to produce warm air decreases. When the seawater temperature drops below 40-45 degrees, it will not be able to produce heat. You should not operate the air conditioner to produce heat when the water temperature is below 40 degrees.

The air conditioning unit creates condensation that drips into the pan at the base of the unit. A hose attached to the pan drains the water by gravity to the drain sump system. It is normal for some water to be in the pan whenever the air conditioner has been used. The condensation pan should be checked periodically to make sure it is draining properly.

The drain hose and condensation pan should be flushed clean if it becomes restricted by mold or debris. If the drain becomes plugged, the condensation pan will overflow onto the cockpit sole.

Exterior Equipment

The intake line for the pump that supplies sea water to cool the unit is equipped with a sea strainer that must be checked for debris frequently and cleaned as necessary. Refer to the Raw Water System chapter for information on the air conditioning pump and cleaning the sea strainer.

You also should refer to the air conditioner owner's manual for additional operating and maintenance instructions.

Notice:

Air conditioners use surface water as a cooling medium. The boat must be in the water and the raw water supply system properly activated prior to use. After a certain amount of time without water flow, air conditioning units will automatically power down. Always check for proper water flow out of the air conditioning pump discharge thru-hull fitting when the cockpit air conditioner is operating.

Mezzanine/Helm Footrest

A folding footrest is located on the mezzanine seat base and the rear of the helm. When the folding footrest on the rear of the helm is up, it provides a more comfortable position when the seat bolsters are set to the seat position. When both footrests are lowered, they create a raised platform that provides better visibility while standing at the helm with the seat bolsters in the leaning post position.

Two spring loaded latches on each side of each footrest secure them in the closed position. To lower the footrests, slide the latches on the helm footrest inboard and rotate the dead bolts up or down to secure in the released position. Then rotate the footrest down. Then follow the same procedure to lower the rear footrest on the forward side of the mezzanine until it sits on the recess in the helm footrest.

To stow the footrest, rotate the rear footrest up against the front of the mezzanine seat base and release the latches. The spring in each latch will automatically slide the bolt and secure the latches. Repeat the process with the helm footrest.

Always make sure the footrests are secured with the latches when they are folded in the stowed position.



Helm & Mezzanine Footrest Folded Down



Helm Footrest



Mezzanine Footrest



Helm Seats with Bolsters Down in Seat Position

Seat Base and Helm Seats

The helm seats are equipped with a flip up bolster to provide more room between the seats and the helm. The bolsters convert the seats to a leaning post style seat with a backrest, allowing the operator and passenger to sit or stand at the helm. To convert each seat to a leaning post, lift the front of the seat cushion to raise the bolster and push it back above the seat cushion.

Arm rests on each side of the seats provide a more comfortable position and swing up into the backrest cushion to make it easier to enter and exit the helm area. A molded in footrest on the rear of the console makes the helm more comfortable when the bolsters are set to the seat position.



Bow Seats & Storage Compartments



Hatch Draw Latch

11.6 Bow Area Seats & Compartments

Bow Seats and Storage Compartments

There are two storage compartments located in the bow below the port and starboard seats that drain overboard through fittings in the hull sides. Each drain fitting is equipped with a removable plug that can be installed to prevent seawater from entering the compartments when they are used for dry storage. The hatches are equipped with gas charged springs that help raise the hatches and hold them in the open or closed position.

Draw latches on the rear of each hatch secure them in the closed position. The bow seat cushions are removable and are secured to the hatches with special fasteners. The cushions should be removed and stored in the cabin or another safe location out of the weather when the boat is not being used.

The rear bow seat cushions are equipped with hinges that convert each bow seat to a forward facing lounge. Ratchet mechanisms in each hinge lock the backrest in the selected position. To adjust the backrest cushions, raise the rear of the cushion. As the cushion is raised the ratchet will click at each preset position. Stop raising the cushion after the click and the cushion will stay in that position. Raise the cushion again to set the backrest to a more upright position.

To lower the cushions, raise the cushion until the ratchet stops clicking. The ratchet mechanism will be released and the cushion can be lowered.



Bow Seat Backrest Down



Bow Seat Backrest Up

Exterior Equipment

Bow Filler Table and Sun Lounge



CAUTION



THE TABLE AND PEDESTAL CAN BE DAMAGED IF THE TABLE IS NOT SLID FORWARD AND LOCKED WHEN IN THE SUN LOUNGE/FISHING DECK POSITION OR SLID AFT WHEN LOWERED FLUSH TO THE COCKPIT SOLE.

A retractable table converts the bow area into either a sitting area with a table or a sun lounge/fishing deck. The table is mounted on an electrically actuated pedestal that is controlled by a rocker switch in the side of the cockpit. Another actuator controlled by a switch in the cockpit moves the table forward or aft.

Each switch is a three position momentary switch. The center position is OFF. Press the top of the switch to raise the table or move it forward, press the bottom of the switch to lower it or move it aft. The pedestal or slide will stop immediately when the switch is released.

To use the bow area for seating without the table, slide the table aft, then lower it to the full down position until it is sitting firmly in the cockpit recess. To use the bow area as a fishing deck, remove the bow cushions and raise the table until it is slightly higher than the bow seat hatches. Then slide the table forward until it stops and lock it in the forward position. Lower the table until it sits firmly on the recess on each side of the cockpit seat bases.

Install the bow seat cushions and the table filler cushion to convert the area to a sun lounge. Remove the filler cushion, raise table and slide it aft to convert the bow area to a sitting area with a table. The filler cushion is stored in the cabin when it is not in use.

To avoid damage to the table and pedestal, always make sure the table is slid aft and lowered so it is sitting firmly in the cockpit recess whenever the boat is operating above slow speed. This is particularly important when the boat is being run offshore.



Table Up



Table in Fishing Deck Position



Table Down

Exterior Equipment

Rod Lockers

There are rod storage lockers behind the bow seat backrest cushions. The locker doors are secured with special "push to close" latches. LED lights illuminate each locker when the hatches are open.

Always make sure the rods are properly secured in the racks with the rod tips forward. The lockers drain by gravity to the bilge.

Forward Below Deck Fishbox

An insulated fishbox is located below the cockpit sole, just forward of the console lounge. The hatch is equipped with gas charged springs that hold it in the open position. Two flush, twist lock latches secure the hatch in the closed position. Always make sure the hatch is closed with the latches in the secured position before operating the boat above idle speed.

The fishbox is drained by a macerator pump in the cabin bilge activated by a switch in the helm switch panel. Be sure to monitor the water level in the fishbox and turn the pump off as soon as pumping is complete. The pump will be damaged if it is allowed to run dry for more than a few seconds. The fishbox should be pumped out and cleaned after each use. Refer to the Drainage Systems chapter for more information on the fishbox drainage.

Drain rails around the hatch are equipped with drains that are connected to thru-hull fittings in the hull.



Forward Below Deck Fishbox Hatch



Forward Fishbox Drain & Drain Rails

Exterior Equipment

11.7 Helm & Console Cabin

Helm

The steering, engine controls, engine instruments and switches for exterior equipment and navigation lights are located on the helm station. An area for flush mounted electronics is located forward of the steering and engine controls. The helm is also equipped with cup holders, inductive charging tray, grab rails and lockable storage and switch compartments. There are also 12 volt accessory plugs and an MP3/USB plug.

Air conditioning ducts in the helm provides cooling to the helm station when the cabin air conditioner option is operating. Additional ventilation is provided by opening the windshield.

A large hatch in the head compartment provides access to the back of the helm panel for servicing helm equipment and installing electronics or other accessories. There are also fuse panels that provide protection for electronics, helm accessories or other equipment added by you or your dealer.

The rear of the helm is hinged at the bottom and can be opened to provide access to service control and steering system components. A heavy duty cable holds the helm in the open position and prevents it from opening too far. Two bolts on each side of the console secure the helm in the closed position.

The helm is heavy and two people are required to open it. To open the helm station, make sure the engines are not running and the battery switches are off. Have one person hold the helm closed while another person removes the bolts that secure the helm to the rear cabin bulkhead. The bolts are located on each side of the console behind the electronics access hatch in the head compartment. Once the bolts are removed, carefully lower the helm to the full open position.

Notice:

The helm is heavy and could open unexpectedly when the last bolt is released. This could break the retainer cable or damage the helm. Make sure you have someone hold the helm closed while the bolts are removed.

Close the helm by having one person push it to the closed position and hold it while another person installs and tightens the bolts. Always make sure that helm is properly closed and secured with both bolts before operating the boat.



Helm

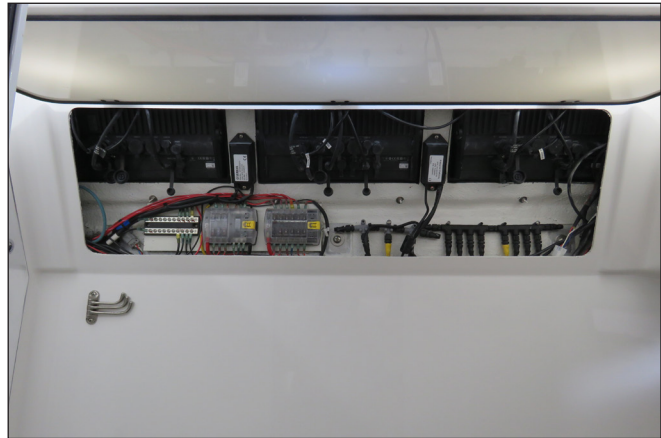

Helm Equipment Access Hatch in Cabin

WARNING

ALWAYS MAKE SURE THE BOLTS THAT SECURE THE HELM STATION ARE TIGHT BEFORE OPERATING OR TRANSPORTING YOUR BOAT. IF THE HELM STATION IS NOT PROPERLY SECURED, IT COULD OPEN UNEXPECTEDLY AND DAMAGE THE BOAT OR CAUSE LOSS OF CONTROL.

WARNING

UNDER NO CIRCUMSTANCES SHOULD THE HELM BE OPENED WHEN THE ENGINES ARE RUNNING. IN SOME SITUATIONS IT IS POSSIBLE TO ACCIDENTALLY ENGAGE THE ENGINE SHIFT CONTROLS INTO GEAR AND ADVANCE THE THROTTLES AS THE HELM IS OPENING. THIS COULD RESULT IN LOSS OF CONTROL, DAMAGE TO THE BOAT AND INJURY TO PASSENGERS.



Windshield

Windshield

Your boat is equipped with a tempered safety glass windshield. The front and side panels are also tempered safety glass.

The windshield slides down to provide ventilation at the helm and/improved visibility. It is lowered and raised by hydraulic cylinders on each side of the windshield. The cylinders are activated by an electric hydraulic pump located in the cabin storage compartment below the berth that is controlled by the WINDSHIELD UP/DN switches in the helm switch panels. You should always monitor the travel of the windshield as it is opened or closed and be ready to release the switch immediately when the windshield reaches the full up or full down position. Refer to the Ventilation chapter for instructions on operating the windshield.

The windshield wiper and washer is standard equipment on your boat. A special lockout mechanism prevents the windshield wiper or washer from activating unless the windshield is closed. You should always make sure the windshield is in the full up position before activating the windshield wiper.

The windshield wiper should only be used when the windshield is wet. The windshield glass can

be scratched by activating the wiper when there is dried salt or dirt on the windshield. The windshield washers are supplied by the fresh water system. Always make sure the fresh water pump is activated before using the windshield washers.

The windshield/hardtop frame is powder coated aluminum. Powder coated aluminum is very durable and provides excellent resistance to the corrosive effects of saltwater, however, it must be maintained properly and certain precautions must be observed.

The windshield should be washed after each use with soap and water to keep it clean and reduce the corrosive effects of the saltwater. Saltwater allowed to remain on the windshield frame will eventually begin to attack the aluminum, usually around fasteners and hardware mounted to the frame.

Do not drill into or install any hardware to the aluminum frame. Poor maintenance or hardware and snaps mounted to the frame can void the warranty on the powder coated windshield/hardtop frame.

Refer to the Routine Maintenance chapter for more information on the care and maintenance of powder coated aluminum.

Exterior Equipment

Cabin Door

The cabin door is on the port side of the console. A spring loaded latch automatically secures the door in the open position and a lockable, push to close latch with a dead bolt secures the door when it is closed.

It is very important that the door is secured properly in the closed position whenever the boat is operated in the closed position whenever the boat is operated above idle speed. The cabin door is heavy and if the door is not closed and properly latched, it could slam shut when the boat rocks and pinch someone's fingers between the door and cabin or damage the door.



WARNING



NEVER LEAVE THE CABIN DOOR UNLATCHED. THE DOOR IS HEAVY AND SWINGS EASILY. IF THE DOOR IS LEFT UNLATCHED, IT COULD SLAM UNEXPECTEDLY AS THE BOAT ROCKS, DAMAGING THE DOOR OR CAUSING AN INJURY TO A PASSENGER. ALWAYS MAKE SURE THE DOOR IS PROPERLY SECURED IN THE OPEN OR CLOSED POSITION.



Cabin Compartment Door

Console Lounge

A double lounge seat with underside cooler/storage is located on the console, forward of the windshield. The lounge seat cushion will accommodate two people and has arm rests and cup holders on each side.

The forward seat cushion is mounted to a hatch that provides access to a compartment below the lounge that can be used for dunnage or as a cooler. The compartment drains by gravity to a thru-hull fitting in the hull.

The hatch is equipped with gas hatch springs that hold the hatch in the open or closed position. A "push to close" latch secures the hatch in the closed position. To prevent the hatch from opening unexpectedly, always make sure the hatch is closed and secured with the latch before operating the boat above idle speed.



Console Lounge Seat



Lounge Seat Cooler/Storage Compartment



Hardtop with Optional Full Upper Station

11.8 Hardtop

The hardtop consists of a laminated fiberglass top mounted to a welded, powder coated aluminum frame that is bolted to the console windshield frame, mezzanine and cockpit sole. It is equipped with White/Blue LED overhead lighting for the helm and a mounting area for a VHF radio and other electronics. Removable panels in the hardtop liner provide access to wiring and rigging for hardtop and upper station accessories. Additionally, it is equipped with a forward mounting pad for a radar antenna and spotlight or optional LED light bar.

The hardtop is designed to accommodate radio antennas, radar antenna, flood lights, navigation lights, rod holders and outriggers. The flood lights, windshield wiper/washer, hardtop lights and retractable windshield are controlled by switches in the helm switch panels.

Hardtops, with or without the optional upper station, are not designed to support the additional weight of heavy items like a life raft. GPS, VHF

and other electronics antennas must be mounted to the top between the front and rear legs. A special mounting location is provided for a radar antenna. Do not mount any antennas or equipment to the brow area forward of the front legs. The hard top frame is not designed to support the weight of accessories in this area and could be damaged. The port and starboard supports on each side of the helm are the wire chase for lights and antennas mounted to the top.

The warranty for the hard top will be void if the top is modified in any way or heavy accessories like life rafts are mounted to the top. Additionally, if items like radar antennas, spotlights and other accessories are mounted in the wrong location, the warranty could be void. If you intend to add equipment or make modifications to the hard top, you should contact Everglades Customer Service or your dealer to make sure the equipment you would like to add or the intended modification will not void the warranty on the top.

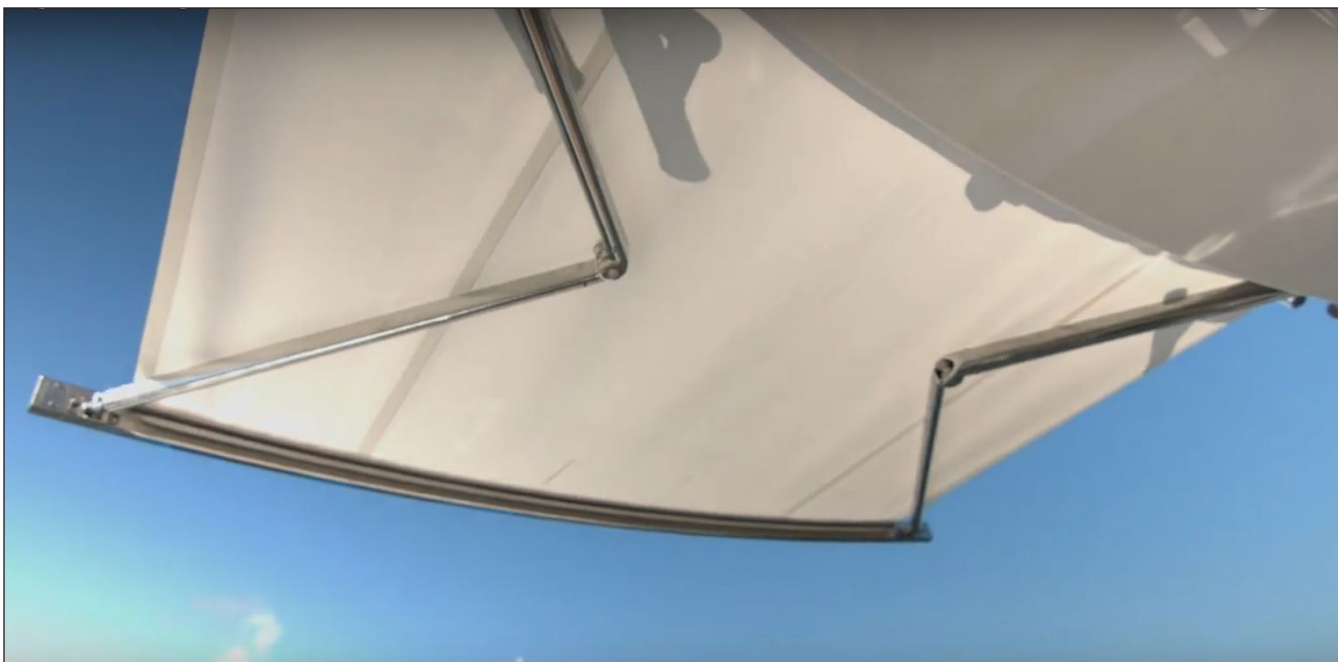

Retractable Sunshade

Retractable Aft Sunshade (Optional)

The optional retractable awning extends to provide shade for the rear cockpit. An electric actuator extends or retracts the awning. The actuator is controlled by the SHADE EXTEND/RETRACT switches in the helm switch panels or with the rocker switch next to the mezzanine bench seat.

When using the switches at the helm, Press the SHADE EXTEND switch to extend the sunshade. Press the switch again to stop the sunshade in the current position. Press the SHADE RETRACT switch to retract the sunshade. Press the switch again to stop the sunshade in the current position.

The awning switch next to mezzanine seat is a three-position rocker switch. The center position is OFF. Press and hold the top of the switch to extend the awning. Press and hold the bottom of the switch to retract it. The switch automatically returns to the OFF position when it is released. Limit switches built into the actuators automatically stop the awning when it is fully extended or retracted.

11.9 Upper Station (Optional)

The optional upper station is a powder coated, welded aluminum frame attached to the hardtop frame above the hardtop. It is equipped with a control station that provides full control of the boat



Upper Helm Station

from the upper helm and a sunshade. A hinged access panel on the underside of the helm provides access to service helm equipment and electrical circuits.

A ladder built into the center rear of the hardtop provides access to the upper station from the cockpit. The rear facing bench seat, footrest and top of the mezzanine are incorporated into the upper station access system to provide steps to the ladder. Grab Rails provide hand holds for safety. An access hatch in the hardtop above the ladder is opened when accessing the upper station and closed for safety during operation.

Exterior Equipment

The access hatch is supported in the open position by a gas spring. It is secured in the closed position by two twist action cam levers on the bottom and top of the hatch. There is a sliding lock on each bottom cam lever to prevent them from opening accidentally.

To open the hatch, release the lock and rotate each cam lever to the open position. The gas spring will automatically lift the hatch to the full open position. To close the hatch, push or pull the hatch to the full down position and secure it with the cam latches. Always secure the hatch in the closed position when people are in the upper station.



WARNING



ACCIDENTALLY STEPPING INTO THE UPPER STATION ACCESS HATCH OPENING CAN CAUSE SEVERE INJURY TO THE OPERATOR OR CREW. ALWAYS MAKE SURE THE UPPER STATION ACCESS HATCH IS CLOSED AND LATCHED WHENEVER PEOPLE ARE IN THE UPPER STATION.

The upper station seats are equipped with a flip up bolster to provide more room between the seats and the helm. The bolsters convert the seats to a leaning post style seat with a backrest allowing the operator and passenger to sit or stand at the helm. To convert each seat to a leaning post, lift the front of the seat cushion to raise the bolster and push it back above the seat cushion.

Do not overload the upper station. It is designed to hold the weight of only two average-sized people. Weight in the upper station raises the boat's center of gravity. Too much weight could make the boat unstable or damage the frame. Refer to the Operation chapter for information on the safe operation of the boat from the upper helm.



Upper Station Seats



Upper Station Ladder, Mezzanine & Sunshade

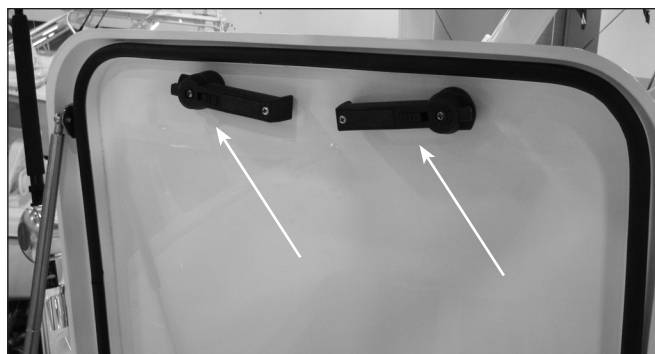

Upper Station Access Hatch Twist Action Cam Levers



Upper Station Access Hatch
Note exterior access hatch cam latch levers.

Exterior Equipment

Folding the Upper Helm Station for Transport

The upper helm station is hinged where it attaches to the hardtop and is designed to fold down to lower the height of the boat for trailering. Gas charged springs at each forward hinge point provide lift assistance and dampening which makes it easier to fold the helm station.

There are two sections to the upper station frame that are secured together with special pins and hand bolts. The forward section includes the upper helm and lowers to scuff pads on the hardtop. The rear section that includes the seats and the sunshade rotates behind the rear of the hardtop and down into the cockpit. A shipping cradle included with your boat is positioned in the cockpit to support the rear section and sunshade in the trailer position.

The upper station sections are heavy and require two people using careful, deliberate action while separating the sections to lower them for transport. It is also important that the sections are secured with straps before transporting the boat on the highway.

To lower the Upper helm station:

1. Before raising or lowering the upper station, the boat should be either on a cradle, the trailer or moored to a dock in a safe location close to the haul out where rough water, wind or boat wakes are not a problem. Also make sure there are no low hanging power lines near the boat that could come in contact with the station or sunshade as it is rotated.
2. Make sure all battery switches are off.
3. Place the cradle for the sunshade and rear section in the center of the cockpit.
4. Remove the outriggers and lower or remove antennas that may interfere with the operation.
5. Fold the seat bolsters up to the leaning post position.
6. Secure 1/2" x 15' nylon handling lines to each side of the sunshade or seat backrest frame.
7. Loosen the hand bolts on each side of the upper station near the seats.
8. With one person on the rear section and one on the front, lift each section slightly to take the strain off the alignment pins where the sections separate.
9. Rotate the rear section just enough to separate it from the front section and carefully lower the front section until it rests on the pads on the hardtop.
10. The person handling the front section can now move to the cockpit to assist in rotating the rear section to the cradle.
11. Lift and rotate the rear section toward the rear of the hardtop. Use the handling lines to carefully and slowly lower the rear section behind the hardtop to the person in the cockpit.
12. As the rear section is lowered, the person in the cockpit will help support the weight and align the cradle.
13. Continue lowering the rear section until it rests in the cradle.



Folding Upper Helm Station



Gas Charged Assist Springs

Exterior Equipment

14. Use straps to secure the front section to the hardtop and the rear section to the stern cleats so the sections don't bounce and cause damage during transport. Make sure to use padding between the straps and powder coated frame to prevent chaffing and damage to the powder coating.

To raise the Upper Helm Station:

1. Make sure there are no low hanging power lines near the boat that could come in contact with the sunshade or upper station frame as it is rotated to the UP position.
2. Make sure all battery switches are off.
3. Remove the straps and position one person on the gunnel near the rear of the hardtop and one in the cockpit.
4. Secure two handling lines to each side of the sunshade. Then position one person in the cockpit and one person on top of the hardtop.
5. With everyone in position and ready, slowly lift the rear section as high as possible. The person in the cockpit should lift the section using the cradle to increase his lifting height.
6. Use the handling lines to continue rotating the rear section until it is in the UP position.
7. While one person on the hardtop holds the rear section, the other person can lift the front section until it aligns with the rear section.
8. Raise or lower each section as required to achieve proper alignment for the pins. Then lower each section slightly to seat them together.
9. With the sections aligned and seated, secure the sections together by tightening the hand bolts. You may have to adjust the sections slightly to achieve proper alignment while starting the bolts.
10. The hand bolts should be torqued as tight as you can get them by hand. Do not use pliers or tools to tighten the hand bolts.

Notice:

Periodically coating the hand bolts with Tef-Gel or anti-seize will lubricate the threads and make loosening or tightening the hand bolts easier. It will also prevent galvanic corrosion that could cause the threads to seize.



Hand Bolt On Each Side
Securing Upper Station Sections

11. Install antennas and outriggers as required. Make sure all connection are secured on the upper station and test all upper helm controls and equipment before operating the boat.



DANGER



ELECTRIC SHOCK FROM LOW HANGING POWER LINES CAN CAUSE SEVERE INJURY OR DEATH IF THEY COME IN CONTACT WITH THE ALUMINUM FRAME FOR THE SUNSHADE AND UPPER STATION. ALWAYS CHECK THE AREA AND MAKE THE BOAT IS A SAFE DISTANCE AWAY FROM ANY POWER LINES BEFORE RAISING OR LOWERING THE UPPER HELM STATION.

11.10 Aftermarket Hardtop or Tower

Everglades does not recommend installing an after market hardtop or tower. An improperly designed or installed fabrication can cause structural damage to the deck structure and void the Limited Warranty. Additionally, Everglades will not be responsible for any damage resulting from the installation of a fabrication not installed at the Everglades factory. If you intend to install an aftermarket hardtop, upper helm station or tower on your boat, please contact your dealer or Everglades Customer Service.

NOTES

INTERIOR EQUIPMENT

12.1 Head Compartment

The head compartment is equipped with a fresh water sink and shower with hot and cold water. A storage compartment and drawers are located in the vanity cabinet below the sink. Another storage compartment is located above the marine toilet.

The water heater is located in a hidden compartment below the sink. The mirror above the sink is hinged and opens to provide access to the digital switch system control modules and circuit breakers.

Most cabinet doors and drawers in the head compartment and cabin are secured in the closed position with special latches that are flush to door or drawer when latched. To open, press and release the knob. The knob will pop out one inch, releasing the locking mechanism and providing a means to pull the door or drawer open. To close, make sure the door is completely closed and push the knob in. The knob will stay in and the locking mechanism will be activated.

The shower head and integrated compartment light is located in the headliner. A T handle control mixer valve allows the water to be turned on and off without affecting the temperature to conserve water while showering. Left to right movement controls water flow and rotating clockwise or counter clockwise controls temperature mixture.



Shower T-Handle Control Mixer Valve



Head Compartment

Interior Equipment



Shower Seat Down



Shower Seat Up

A hinged teak seat swings down above the toilet to provide a comfortable place to sit while showering. The seat is flush to the wall when folded up to use the toilet and is secured by a spring loaded latch. Make sure the latch is completely engaged when the seat is folded up.

Shower water drains to the sump system through a removable grate where it is pumped overboard. An automatic switch in the sump activates and controls the pump while showering.

Ventilation is provided by an opening window above the marine toilet and an exhaust blower activated by the light switch. There are also 12 volt LED lights in the headliner and shower head that are activated by switches near the cabin door.

There are large access hatches in the rear bulkhead. The upper compartment provides a mounting area for electronics control modules and access to the back of the helm station to service components. The fuses that protect some 12 volt helm accessories and electronics are located in fuse panels mounted in this compartment. The bolts that secure the opening helm section are also located on each side of the helm behind the upper hatch.

Access to the forward bilge is provided through the lower removable hatch in the rear bulkhead. The stereo amplifiers, waste tank macerator discharge pump and forward bilge pump and automatic switch are among the equipment installed in the forward bilge compartment.

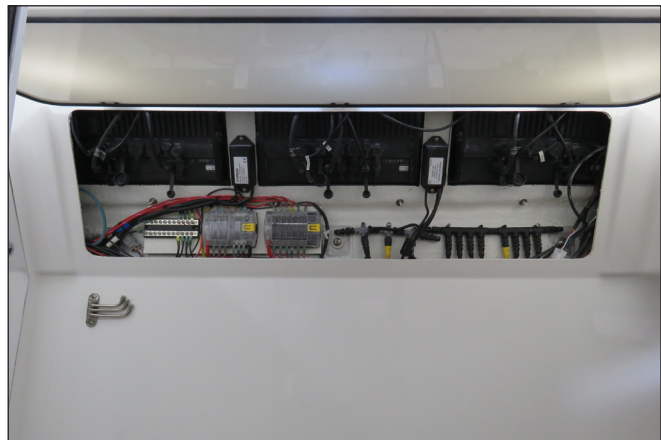

Upper Access Door & Compartment

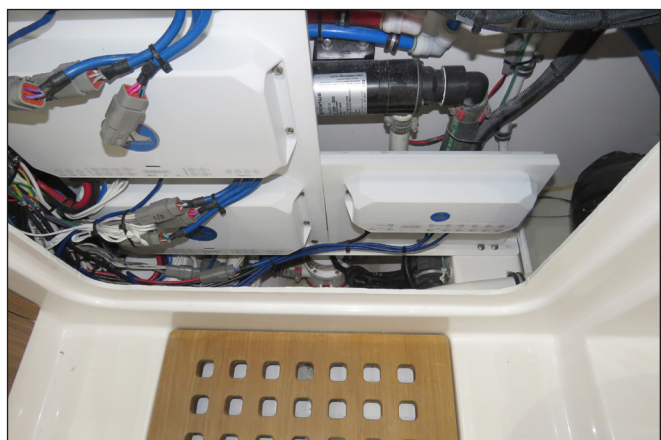

Lower Compartment & Access to Forward Bilge

Interior Equipment

12.2 Marine Head System

Your boat is equipped with an electric marine toilet (head) and holding tank as standard equipment. A momentary switch in the panel on the head compartment bulkhead controls the filling and flushing of the toilet. Flush water is supplied by the freshwater system. Before using, make sure the freshwater system is activated and press the flush button briefly to wet the inside of the bowl. After use, activate the pump to discharge the waste to the holding tank and empty the bowl.

Refer to the toilet manufacturer owner's manual for more information on the operation and maintenance of the marine head.

Holding Tank and Overboard Discharge Pump

The holding tank is located in the bilge. You should monitor the fluid level in the holding and do not flush the toilet when the tank is full. The holding tank must either be pumped out by an approved waste dumping station through the waste deck fitting or be pumped overboard with the macerator discharge pump, when legal to do so.

A switch with a key activated lockout is located in the head compartment switch panel. The overboard macerator discharge pump is in the forward bilge below the lower removable access hatch in the head compartment. The discharge valve is in the cabin bilge next to the sump system. The pump discharges holding tank waste to a thru-hull fitting in the hull below the waterline.

To operate the overboard discharge pump, make sure the thru-hull valve in the bilge is open. Then turn the key switch in the panel to the ON position. Press and hold the momentary button below the key switch to activate the pump.



Marine Toilet



Toilet & Overboard Discharge Control Panel



Overboard Macerator Discharge Valve



Overboard Macerator Discharge Pump

Interior Equipment



Monitor the fluid level in the holding tank as it is pumped out. When pumping is complete, release the button, close the pump out thru-hull valve and turn the key switch OFF. Remove the key from the switch and store in a safe location.

Notice:

Monitor the waste level in the holding tank as the overboard discharge pump drains the tank and turn the pump off immediately when draining is complete. The macerator discharge pump will be damaged if it runs dry for more than a couple of seconds.

Notice:

In order to comply with current State, Federal and Coast Guard regulations, the lockout key switch must be off and the key removed whenever the boat is operating in areas in where the discharge of sewage is prohibited.

	CAUTION	
<p>IN MANY AREAS IT IS ILLEGAL TO FLUSH HEAD WASTE DIRECTLY OVERBOARD. VIOLATION OF THESE POLLUTION LAWS CAN RESULT IN FINES OR IMPRISONMENT. ALWAYS KNOW THE LAW FOR THE AREAS IN WHICH YOU BOAT. NEVER DUMP HEAD OR HOLDING TANK WASTE OVERBOARD ILLEGALLY.</p>		

Maintenance

The head should be cleaned and inspected for leaks regularly.

The holding tank should be pumped out and flushed as needed. Always add chemical to the holding tank to help control odor and to chemically break down the waste. See the head manufacturer owner's manual for additional operating and maintenance information.

To reduce odor in the cabin, never allow waste to remain in the holding tank for more than one week. Make sure to add fresh water to the holding tank and pump the tank several times to flush it out during pump out operations.

Important:

The head system must be properly winterized before winter lay-up. Please refer to the Seasonal Maintenance chapter and the manufacturer owner's manual for winterizing instructions.



Main Cabin

12.3 Main Cabin

Cabinet Door and Drawer Latches

Most cabinet doors and drawers in the cabin are secured in the closed position with special latches that are flush to door or drawer when latched. To open, press and release the knob. The knob will pop out one inch, releasing the locking mechanism and providing a means to pull the door or drawer open. To close, make sure the door is completely closed and push the knob in. The knob will stay in and the locking mechanism will be activated. Other doors are held closed by “push to close” latches that latch automatically when the door is closed.

Cabin Light Switches

All lights in the cabin are powered by the DC electrical system. The overhead lights for the cabin and head compartment are activated by ON/OFF switches in a panel on the cabin wall near the companionway. Other lights have switches on the light fixture.



Cabin Switch Panel

Interior Equipment

Cabinets and Storage Compartments

The cabin is equipped with a microwave and cabinets for storage. The counter top is Faux Granite and the microwave is built into the cabinet above the cabin countertop. Cabinets next to the microwave and below the counter top provide storage. There is also a drawer in the lower cabinet and additional storage below the cabin step.

Daylight and fresh air is provided to this area by opening port windows on each side of the cabin. Additional lighting is provided by overhead lights that are controlled by an ON/OFF switch in the cabin switch panel. There is also a 120 volt GFI outlet.

Microwave Oven

A microwave oven is standard equipment. The microwave operates on AC power and is activated and protected by the Outlets breaker in the AC breaker panel. Always make sure the microwave door is closed and latched whenever the boat is underway. Refer to the microwave owner's manual for detailed information on the operation of the microwave oven installed in your boat.

Cabin Electrical Breaker Panel

The cabin AC breaker panel is built into the cabinet on the starboard side of the cabin, below the microwave. The stereo, refrigeration/freezer plate controller, generator control panel, blower switch and battery charger control panels are mounted in the this panel.

Refer to the Electrical Systems chapter for more information on the operation of the components in the AC panel.

Stereo

The stereo is mounted in the cabin electrical panel. Key pads with LED displays mounted at the helm and in the cockpit allow the stereo to be controlled from various locations. Refer to the stereo owner's manual for detailed information on the operation of the stereo and key pads.



Cabinets, Storage Compartments, Microwave & Drawer



Cabin AC Electrical Panel

Interior Equipment

TV

The TV is mounted on the forward cabin bulkhead. It is activated by a circuit breaker in the AC electrical panel. Refer to the TV owner's manual for detailed information on the operation of the TV.

Cabin Table (Optional)

A removable table and pedestal are optional. The pedestal and table are stowed in special brackets in a compartment below the forward berth cushion when the dinette is converted to a berth or while the boat is underway.

To install the table, pull the release pin and slide the pedestal onto the bracket. Release the pin to secure the pedestal on the bracket. Place the table on the pedestal.

To remove and store the table, remove the table from the pedestal and set it on a the port rear berth cushion. Pull the release pin on the side of the table pedestal bracket and slide the pedestal up and out of the bracket. Store the pedestal and table in the brackets in the table storage compartment.

To avoid damage to the table and pedestal, always make sure the table and pedestal are removed and stowed whenever the boat is operating above slow speed. This is particularly important when the boat is being run offshore.

Carbon Monoxide Detector

A carbon monoxide (CO) detector/alarm is installed on the starboard aft cabin wall. The detector is always activated when the house batteries are connected and is protected by a fuse in the continuous power fuse panel. If excess carbon monoxide fumes are detected, an audible beeping will sound indicating the presence of the toxic gas. A green light on the detector indicates that it is activated. Always make sure the green light is on whenever the cabin is occupied.

A by-product of combustion, carbon monoxide is invisible, tasteless, odorless and is produced by all engines and some heating and cooking appliances. The most common sources of CO on boats are the engines, auxiliary generators and propane or butane stoves. These produce large amounts of CO and should never be operated while sleeping.



TV on Forward Bulkhead & Table



Table Pedestal Bracket & Release Pin



Table Stored in Storage Compartment
Below Forward Berth Cushion

Interior Equipment

You should read the owner's manual supplied by the detector manufacturer for operation instructions and additional information regarding the hazards of carbon monoxide gas. Also read more about carbon monoxide, carbon monoxide detectors and proper ventilation in the Ventilation System and Safety Equipment chapters in this manual. This is especially essential since your boat is equipped with a generator as standard equipment. If you did not receive a manual for your carbon monoxide detector, please contact the Everglades Customer Service Department.



WARNING



ACTIVATION OF THE CARBON MONOXIDE DETECTOR INDICATES THE PRESENCE OF CARBON MONOXIDE (CO) WHICH CAN BE FATAL. EVACUATE THE CABIN IMMEDIATELY. DO A HEAD COUNT TO CHECK THAT ALL PERSONS ARE ACCOUNTED FOR. DO NOT REENTER THE CABIN UNTIL IT HAS BEEN AIRED OUT AND THE PROBLEM FOUND AND CORRECTED.



Cabin Carbon Monoxide Detector

Cabin Lounge Seat and Berth

The lounge seat located in the forward section of the cabin converts to a berth. There are hatches below the cushions that provides access to the batteries, water tank, fresh water pump and forward fishbox pump. Other hatches behind the backrest cushions provide access to the battery switches, fuse panels, circuit breakers and other electrical equipment. You should not store dunnage in these compartments.



Cabin Lounge Seat

To convert the lounge seat to a berth, make sure the table is removed and stored, if your boat is equipped with this option. Then insert the berth filler cushions to complete the conversion.

To convert the berth to a lounge seat, remove and store the filler cushions.



Cabin Lounge Seat Converted to a Berth

Interior Equipment

12.4 Air Conditioner

The air conditioning unit is the reverse cycle type and operates on AC power. The unit is equipped with reverse cycle heat and can be operated as a cooling or heating unit. It is protected by circuit breakers in the AC breaker panel.

To operate the system, make sure the thru-hull valve for the air conditioner seawater supply pump is on. The valve, sea strainer and pump are located in the aft systems compartment bilge. Turn the HVAC Unit FORWARD and HVAC Pump breakers in the AC breaker panel on. The air conditioning or heat then will be controlled by the electronic control panel in the cabin. When activated, water should continuously flow from the overboard discharge thru-hull.

The air conditioning system produces heat when it is operated in the reverse cycle mode. The ability of the unit to produce heat is affected by the temperature of the seawater. As the seawater temperature lowers, the air conditioner's ability to produce warm air decreases. When the seawater temperature drops below 40 - 45 degrees, the unit will not be able to produce heat. You should not operate the air conditioner to produce heat when the water temperature is below 40 degrees.

Always keep the cabin door closed when operating the air conditioner. If the cabin door is left open, it could cause the air conditioner unit to run continuously and not cycle enough to defrost the condenser coils. This could cause the coils to develop enough ice to reduce the unit's ability to cool the boat.

The air conditioner is located the cabin steps. It creates condensation that drips into the pan at the base of the unit. A hose attached to the pan drains the water to the cabin drain sump where it is pumped overboard. You should monitor the operation of the sump pump system and make sure it is operating properly whenever the cabin air conditioner is activated. The air conditioner can produce enough condensation to flood the cabin sole if it is allowed to run for extended periods without the sump system operating properly.

It is normal for some water to be in the condensation pan whenever the air conditioner has been used. The pan should be checked periodically to make sure it is draining properly. The drain hoses, condensation pan and sump should be flushed clean if they become restricted by mold or debris. A seawater pump supplies cooling water for the



Air Conditioner Control Panel

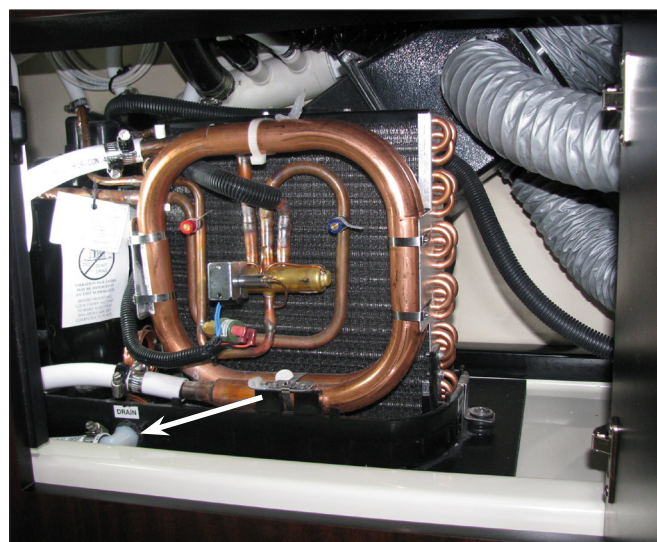

Typical Cabin Air Conditioning Unit & Condensation Pan Drain

cabin air conditioning unit. The intake line for the seawater pump is equipped with a sea strainer that must be checked for debris frequently and cleaned as necessary. Refer to the Raw Water System chapter for information on the air conditioning pump and cleaning the sea strainer. You should also refer to the air conditioner owner's manual for additional operating and maintenance instructions.

Notice:

Air conditioners use seawater as a cooling medium. The boat must be in the water and the raw water supply system must be properly activated prior to use. Operation without proper cooling could cause the air conditioning unit to shut down and could cause system damage. Always check for proper water flow out of the air conditioning pump discharge thru-hull when the air conditioner is operating.

Interior Equipment

12.5 Cabin Woodwork

Cabin Floors

The cabin floor and steps are a simulated wood material with teak image and texture. It is important to avoid tracking sand and dirt on the cabin floor and steps. Sand and dirt acts like sand paper and will eventually damage the finish in the traffic areas.

The floors and steps can be vacuumed and cleaned with a mixture of water and Murphy's Oil Soap. Wipe dry with a clean towel.

Walls, Cabinets and Trim

The hardwood used for the cabinet trim moldings is finished with a high quality urethane varnish. The galley cabinets are made of a laminated, simulated wood that requires no maintenance. The walls and molding can be routinely cleaned with a damp cloth. For heavy duty cleaning, use a mixture of water and Murphy's Oil Soap or white vinegar and water to clean the wood or laminate and wipe it dry with a clean towel. Apply a furniture polish to add luster and help to preserve the finish.



Typical Cabin Simulated Wood Floor



Typical Cabin Simulated Wood Steps

ROUTINE MAINTENANCE

13.1 Exterior Hull & Deck

Hull Cleaning-Below The Water Line

When the boat is removed from the water, clean the outer bottom surface immediately. Algae, grass, dirt and other marine growth is easier to remove while the hull is still wet. Use a pressure cleaner or a hard bristle brush to clean the surface.

Bottom Painting

If the boat is to be left in saltwater for extended periods, the hull must be protected from marine growth by antifouling paint. Because of variations in water temperature, marine growth and pollution in different regions, a qualified boat yard in your area should be consulted when deciding what bottom paint system to apply to your hull. This is extremely important as pollution and marine growth can damage fiberglass hulls.

Use only standard antifouling paints and fiberglass wax removers and primers recommended by the antifouling paint manufacturer when preparing the hull for bottom paint. Light sanding, just enough to scuff the gel coat or a skip sand primer system can be used to prepare the hull for bottom paint. The use of a coating other than standard antifouling paint or epoxy barrier coatings are not recommended and will void the hull blister warranty.

Do not allow the hull antifouling paint to contact the outboard motors. Most antifouling paints designed for hull bottoms contain copper and can cause severe galvanic corrosion damage to the motors. Always leave at least a 1" barrier between the hull bottom paint and outboard motors.

CAUTION

SANDBLASTING THE HULL BOTTOM WILL DAMAGE THE FIBERGLASS. USE A FIBERGLASS WAX REMOVER AND SAND TO SCUFF THE GELCOAT SURFACE. THE INSTRUCTIONS AND RECOMMENDATIONS OF THE BARRIER COATING AND ANTIFOULING PAINT MANUFACTURERS SHOULD BE FOLLOWED EXACTLY.

CAUTION

BARRIER COATINGS AND BOTTOM PAINT SHOULD BE APPLIED ONLY BY QUALIFIED MARINE PROFESSIONALS IN A BOAT YARD OR DEALERSHIP THAT SPECIALIZES IN THEIR APPLICATION. USE ONLY STANDARD, HIGH QUALITY ANTIFOULING PAINTS AND BARRIER COATINGS FROM NAME BRAND MANUFACTURERS SUCH AS INTERLUX AND PETTIT.

DO NOT ALLOW THE HULL ANTIFOULING PAINT TO CONTACT THE OUTBOARD MOTORS. MOST ANTIFOULING PAINTS DESIGNED FOR HULL BOTTOMS CONTAIN COPPER AND CAN CAUSE SEVERE GALVANIC CORROSION DAMAGE TO THE OUTBOARD DRIVE UNIT. USE ONLY ANTIFOULING PAINT DESIGNED FOR OUTBOARD MOTORS IF APPLYING ANTIFOULING PAINT TO THE ENGINES. ALWAYS LEAVE A ONE INCH BARRIER BETWEEN THE HULL BOTTOM PAINT AND OUTBOARD MOTOR.

Most bottom paints require some maintenance. Proper maintenance is especially important when the boat is in saltwater and not used for extended periods or after dry storage. If the hull bottom has been painted with antifouling paint, contact your dealer or local boat yard for the recommended maintenance procedures.

Anodes

Sacrificial anodes are installed on the outboard motors, engine clamp brackets and could be installed on the trim tabs. Your boat is equipped with a large anode on the transom that is connected to the bonding system. The transom anode provides additional protection against galvanic corrosion for the engines, thru-hull fittings and other underwater hardware that is bonded.



Typical Transom Anode

Routine Maintenance

The anodes are less noble than copper based alloys, stainless steel and aluminum. They will deteriorate first, protecting the more noble underwater hardware against galvanic corrosion. They must be monitored if the boat is to be left in the water. Anodes should be checked monthly and changed when they are 75% of their original size. When replacing the anodes, make sure the contact surfaces are clean, shiny metal and free of paint and corrosion. Never paint over the anode.

Boats stored in saltwater will normally need to have the anodes replaced every 6 months to one year. Anodes requiring replacement more frequently may indicate a stray current problem within the boat or at the slip or marina. Anodes that do not need to be replaced after one year may not be providing the proper protection. Loose or low quality anodes could be the problem. Contact your dealer or Everglades Customer Service for the proper size and type of anodes to be used and the specific installation procedure.

Fiberglass Gel coat

Normal maintenance requires only washing with mild soap and water. A stiff brush can be used on the nonskid areas. Kerosene or commercially prepared products will remove oil and tar which could be a problem on trailered boats. Harsh abrasive and chemical cleaners are not recommended because they can damage or dull the gel coat, reducing its life and making it more susceptible to stains. When the boat is used in saltwater, it should be washed thoroughly with soap and water after each use.

At least once a season, wash and wax all exposed fiberglass surfaces. Use a high quality automotive or boat wax. Follow the procedure recommended by the wax manufacturer. The washing and waxing of your boat will have the same beneficial effects as they have on an automobile finish. The wax will fill minute scratches and pores thus helping to prevent soiling and will extend the life of the gel coat or paint.



After the boat is exposed to the direct sunlight for a period of time, the gel coat or painted surfaces tend to fade, dull or chalk. A heavier buffing is required to bring the finish back to its original luster. For power cleaning use a light cleaner. To clean the boat by hand, use a heavier automotive cleaner. Before cleaning the surfaces, read the instructions given with the cleaner. After cleaning the surfaces, apply wax and polish all fiberglass surfaces except the nonskid areas.

Avoid the following on gelcoat surfaces:

- Do not use plastic or other nonporous (non-breathable) materials to cover gelcoat surfaces. Trapped moisture from condensation can cause gelcoat damage. Shrink wrap storage covers must be properly ventilated, including hull sides.
- Do not use abrasives, bleaches, ammonia, acids or harsh detergents. See your dealer for special marine formulations. Harsh abrasive and chemical cleaners are not recommended because they can damage or dull the gelcoat, reducing its life and making it more susceptible to stains.
- NEVER apply wax or buffing compound to a gelcoat surface in direct sunlight.

Chalking, stains and minor scratches can be removed in most cases with careful rubbing and polishing with appropriate compounds or chemicals and is best done by a professional - see your dealer.

If the fiberglass should become damaged and need repair, contact your dealer or Everglades Customer Service for assistance in finding an authorized repair person to make the repairs.

	CAUTION	
DO NOT WAX NONSKID AREAS AS THIS COULD MAKE THEM SLIPPERY AND CONSEQUENTLY INCREASE THE POSSIBILITY OF INJURY.		

Stainless Steel Hardware

When using the boat in saltwater, the hardware should be washed with soap and water after each use. When your boat is used in a corrosive environment such as saltwater, water with a high sulfur content or polluted water, the stainless steel will periodically develop surface rust stains. This is perfectly normal under these conditions.

The following guidelines will help keep stainless steel looking good for many years.



- Clean stainless steel frequently (daily in salt or polluted environments) with mild soap and plenty of water. Any cleaner safe for use on glass is usually safe for stainless.

Routine Maintenance

- Remove rust spots (especially around welds) immediately with a brass, silver or chrome cleaner. Irreversible pitting will develop under rust allowed to remain on stainless for any period of time.
- Remove rust stains on gelcoat. See dealer for recommended product.
- Stainless Steel can normally be cleaned and protected by using a high quality boat or automotive wax or a commercial metal cleaner and protectant.

Never do the following on Stainless Steel.

- Do not use coarse abrasives like sandpaper or steel wool which may actually cause rusting.
- Do not use acids or bleaches which may etch the naturally occurring protective coating.
- Do not leave stainless steel in contact with iron, steel or other metals which cause contamination leading to rust or corrosion.

 **CAUTION** 



UNDER NO CIRCUMSTANCES SHOULD ANY ABRASIVE MATERIALS SUCH AS SANDPAPER, BRONZE WOOL OR STEEL WOOL BE USED ON STAINLESS STEEL. DAMAGE TO THE HARDWARE WILL RESULT.

Anodized Aluminum Surfaces

Anodized aluminum should be washed periodically with soap and water to keep it clean. If the boat is used in saltwater or polluted water, the aluminum should be washed with soap and water after each use. Saltwater allowed to remain on anodized aluminum will penetrate the anodized coating and attack the aluminum.

Hardtops, bimini tops or T-tops with canvas and/or fiberglass tops require special attention to the anodized aluminum just below the top. This area is subject to salt build up from salty condensation and sea spray. It is also frequently overlooked when the boat is washed and will not be rinsed by the rain. Consequently, the aluminum just below the top is more likely to become pitted than the exposed aluminum on the structure. Make sure the aluminum in this area is washed frequently with soap and water and rinsed thoroughly. Pay particular attention to places where the top material or lacing contact the frame. Once a month coat the entire frame with a metal protector made for

anodized aluminum to protect against pitting and corrosion caused by the harsh effects of saltwater. Do not use automotive or boat wax designed for paint or gel coat on anodized aluminum. The wax can contaminate the aluminum and damage the anodized surface.

 **CAUTION** 

ONE DRAWBACK TO METAL PROTECTORS IS THAT THEY CAN MAKE THE METAL SLIPPERY. THEREFORE, THEY SHOULD BE NOT BE USED ON TOWER LADDERS, STEERING WHEELS AND OTHER AREAS WHERE A GOOD GRIP AND SURE FOOTING IS IMPORTANT.

Stains can be removed with a metal polish or fine polishing compound. To minimize corrosion, use only high quality stainless steel fasteners on aluminum fabrications. Isolate the fasteners from the aluminum by using fiber washers and caulking compound or Tef Gel to bed hardware and fasteners mounted to aluminum fabrications. If the anodized coating is badly scratched, it will require special attention and more frequent cleaning to the damaged area. With proper care, anodized aluminum will provide many years of service.

Powder Coated Aluminum

Powder coated aluminum should be washed periodically with soap and water to keep it clean. If the boat is used in saltwater or polluted water, the aluminum should be washed with soap and water after each use. Saltwater allowed to remain on powder coated aluminum will penetrate the coating and attack the aluminum, usually around fasteners and hardware mounted to the aluminum.

Pay special attention to the area just below the top. This area is subject to salt buildup from salty condensation and sea spray. It is also frequently overlooked when the boat is washed and will not be rinsed by the rain. Consequently, the powder coating near fasteners and hardware mounted just below the top is more likely to be attacked by the salt and become corroded than the exposed areas on the structure. Make sure the aluminum in this area is washed frequently with soap and water and rinsed thoroughly. Pay particular attention to places where the top material or lacing contact the frame.

Once a month check the entire frame for damaged powder coating and corrosion around fasteners and hardware. Nicked or badly scratched pow-

Routine Maintenance

der coating can be sanded and touched up with enamel paint. Corrosion will have to be sanded, then touched up with paint. Periodically applying automotive or boat wax to the powder coating will provide additional protection from the harsh effects of saltwater.

We recommend that you do not drill into or install any hardware to the aluminum frame. Poor maintenance or hardware and snaps mounted to the fabrication can void the warranty on powder coated frames. If you do install hardware to the frame, the fasteners will require fiber washers and sealing with caulk or Tef Gel to isolate the fastener from the aluminum and reduce damage to the powder coating when the fastener is installed.

Always repair scratches, nicks and corroded areas in powder coating as soon as possible. Corrosion left unaddressed will lift the powder coating allowing moisture to travel between the powder coating and the aluminum causing the corrosion to spread below the coating and damage the aluminum.

If excessive chipping and peeling occurs, it could be an indication of an electrical fault in the boat or aluminum fabrication. You should contact a qualified marine electrician to inspect your boat immediately and correct the problem if you suspect that your boat may have a fault in the aluminum frame. You should also contact your dealer or Everglades Customer Service.

Notice:

Boats that are towed behind larger vessels require special attention to the aluminum hardware. The salt spray, salty steam and chemicals in exhaust gases are particularly corrosive and will damage the surface of anodized or powder coated aluminum. It is imperative that the boat and the aluminum are cleaned thoroughly at the completion of each trip or at the end of each day on long cruises to reduce accelerated deterioration of the anodizing or powder coating and premature corrosion to the aluminum.

Notice:

You should contact Everglades Customer Service before making any modifications to aluminum fabrications. Unauthorized modifications can void the warranty.

Chrome Hardware

Use a good chrome cleaner and polish on all chrome hardware.

Acrylic Plastic Glass

Acrylic glass scratches easily. Never use a dry cloth or glass cleaning solutions on acrylic. Use a soft cloth and mild soap and water for routine cleaning. Solvents and products containing ammonia can permanently damage acrylic plastic glass.

Fine scratches can be removed with a fine automotive clear coat polishing compound. A coat of automotive or boat wax is beneficial to protect the surface.

Do not use the following on acrylic glass:

Abrasive cleaners	Acetone
Solvents	Alcohol
Cleaners containing ammonia	Glass cleaners

13.2 Upholstery, Canvas & Enclosures

Vinyl Upholstery

The vinyl upholstery used on the seats, cushions, bolsters and for the headliner in some cabins, should be cleaned periodically with mild soap and water. Any stain, spill or soiling should be cleaned up promptly to prevent the possibility of permanent staining. When cleaning, always rub gently. Avoid using products containing ammonia, powdered abrasive cleaners, steel wool, ink, strong solvents, acetone and lacquer solvents or other harsh chemicals as they can cause permanent damage or shorten the life of vinyl. Never use steam heat, heat guns or hair dryers on vinyl.

Stronger cleaners, detergents and solvents may be effective in stain removal, but can cause either immediate damage or slow deterioration. Lotions, sun tan oil, waxes and polishes, etc., contain oils and dyes that can cause stiffening and staining of vinyls.

- Dry soil, dust and dirt - Remove with a soft cloth.
- Dried on dirt - Wash with a soft cloth dampened with water.
- Variations in surface gloss - Wipe with a water dampened soft cloth and allow to air dry.
- Stubborn dirt - Wash with a soft cloth dampened with Ivory Flakes® and water. Rinse with clean water.

Routine Maintenance

- Stubborn spots and stains - Spray with either Fantastik Cleaner® or Tannery Car Care Cleaner® and rub with a soft cloth. Rinse with clean water.
- Liquid spills - Wipe immediately with a clean absorbent cloth. Rinse with clean water.
- Food grease and oily stains - Spray immediately using either Fantastik Cleaner® or Tannery Car Care Cleaner®, wiping with a soft cloth. Take care not to extend the area of contamination beyond its original boundary. Rinse with clean water.

Acrylic Canvas (Sunbrella)

Modern, bright colored canvas tops are usually fabricated from acrylic fabrics with the trade names like Sunbrella®, Argonaut®, etc. Acrylic fabrics look similar to cotton canvas but are much more durable and color fast.

Acrylic canvas can be cleaned by using Ivory Flakes, Ivory Liquid or another mild soap and water. Scrub lightly and rinse thoroughly to remove the soap. Do not use detergents, as they will deteriorate the waterproofing in the fabric. The underside can be brushed with a soft brush and sprayed with a disinfectant to prevent the accumulation of dirt and mildew. The top or accessories should never be folded or stored wet.

In fresh water areas, the top and curtains should be washed weekly. This is particularly important if the boat is stored near a highway, airport or in a large city. Residue from jet fuel, exhaust fumes and industrial pollution can shorten the life of tops and enclosures.

In saltwater areas, the top and curtains should be rinsed with fresh water after each use and at least weekly if it is stored outside. Saltwater attracts moisture and dirt can shorten the life of fabric tops and enclosures. The salt is also abrasive and can cause premature wear in the fabric and stitching.

After several years, the acrylic canvas may lose some of its ability to shed water. If this occurs, wash the fabric and let it dry thoroughly. Then treat the outside surface with a commercially available waterproofing designed for this purpose. Waterproofing is available in bulk at most canvas shops. One-gallon garden sprayers are excellent for applying waterproofing.

Notice:

Some leakage at the seams is normal and unavoidable with acrylic enclosures.

Laminated Vinyl

Laminated vinyl top material is a lamination of two plies of specially formulated vinyl with an inner reinforcing core fabric. The most common trade names for this fabric is Weblon® or Stamoid®. It is not unusual for the interior ply to be a different color than the exterior. There is a greater tendency for this type of fabric to leak at the seams than with acrylic or vinyl coated polyester. Paraffin wax that matches the top can be used to seal the seams if necessary.

Laminated vinyl fabrics should be cleaned periodically by using Ivory Flakes, Ivory Liquid or another mild soap and water. Scrub lightly and rinse thoroughly to remove the soap. Do not use detergents or harsh cleaners like bleach and ammonia. They will attack the vinyl in the fabric and shorten its life. The top or accessories should never be folded or stored wet.

In fresh water areas, the top and curtains should be washed weekly. This is particularly important if the boat is stored near a highway, airport or in a large city. Residue from jet fuel, exhaust fumes and industrial pollution can shorten the life of tops and enclosures.

In saltwater areas, the top and curtains should be rinsed with fresh water after each use and at least weekly if it is stored outside. Saltwater attracts moisture and dirt which can shorten the life of fabric tops and enclosures. The salt is also abrasive and can cause premature wear in the stitching.

Clear Curtains and Connectors

Side curtains and clear connectors can be cleaned with mild soap and water. They should not be allowed to become badly soiled. Dirt, oil, mildew and cleaning agents containing ammonia, will shorten the life of the vinyl that is used for clear curtains. After cleaning the curtains and allowing them to dry, apply a non-lemon furniture polish or an acrylic glass and clear plastic protector to extend the life of the curtains.

Vinyl curtains should be stored either rolled or flat, without folds or creases. Folding the curtains will make permanent creases that could cause the vinyl to crack.

Routine Maintenance

Notice:

Do not use any polish containing lemon scents or lemon. The lemon juice will attack the vinyl and shorten its life.

Snaps should be lubricated periodically with Teflon or silicone grease or a lubricant designed for snaps. Zippers should be lubricated with silicone spray, paraffin or silicone stick.

Strataglass

Strataglass® is a special coated vinyl that could be used in the curtains for the hardtop enclosure. The coating protects the vinyl glass and resists scratching. Waxes and Plexiglas polishing compounds should not be used on strataglass as the protective coating prevents them from penetrating into the vinyl and they will build up on the surface. These products will create a hazy, greasy appearance that will affect the clarity of the strataglass. Products that repel water, like Rainex®, should not be used as they will not take well to the surface and could appear spotty and may also yellow or dull the Strataglass over time.

Strataglass can be cleaned by rinsing off dirt or salt deposits with fresh water, then washing with a clean cloth and mild soap. Chamois dry to remove water spots and improve clarity. If a polish is accidentally used, use Windex® or its equivalent to remove it. While window cleaners will destroy the standard vinyl normally used in side curtains and clear connectors, it will not harm strataglass. Always roll down the curtains and snap in place at the end of each day so the curtains will maintain their shape and to minimize fold distortions.

Depending upon usage, it is recommended that an occasional application of Aquatech Strataglass Cleaner be done. Treat this like a polish, as opposed to a cleaner - wash and dry curtains first, then apply Aquatech Strataglass Cleaner, actually buffing the surface to a beautiful sheen. This is not just a wipe on/ wipe off product...it needs to be buffed to perform.

Remember, the coating on strataglass is scratch resistant and not scratch proof. Always handle the curtains with care and never roll up curtains that are salty or dirty. If you have any questions about the clear curtains used on your boat, please contact your dealer or Everglades Customer Service.

Notice:

Hardtop enclosures must be removed when trailering. Canvas enclosures are not designed to withstand the extreme wind pressure encountered while trailering and will be damaged. Always remove and properly store the enclosure before trailering your boat.

13.3 Interior

The cabin or head interior can be cleaned just like you would clean a home interior. To preserve woodwork, use teak oil. To maintain carpeting, use a vacuum cleaner. Because air and sunlight are very good cleansers, periodically put cushions, sleeping bags, etc. on deck, in the sun and fresh air, to dry and air out. If cushions or equipment get wet with saltwater, remove and use clean, fresh water to rinse off the salt crystals. Salt retains moisture and will cause damage. Dry thoroughly and reinstall.

Vinyl headliner material should be cleaned periodically as explained in the previous section. Avoid using products containing ammonia, bleach or harsh chemicals as they can shorten the life of vinyl. Fiberglass headliners should be wiped down with a damp towel as necessary to remove dust and dirt.

If you leave the boat for a long period of time, put all cushions on their sides, open all interior cabin and locker doors and hang a commercially available mildew protector in the cabin.

Notice:

Always read the label carefully on mildew protectors. Remove the protector and allow the cabin to ventilate completely before using the cabin.

Counter Tops - Faux Granite

A mild liquid detergent and water or disinfectant cleaners will remove most dirt and stains from Faux Granite. Rinse with a clean cloth moistened with fresh water. Wipe dry with a clean cloth.

Never use granite cleaners, bleaches, ammonia, household cleaners, polishes or scouring pads. Harsh cleaners and scouring pads will damage the polymer surface of Faux Granite.

Routine Maintenance

In most cases, Faux Granite can be repaired if accidentally damaged. Small scratches that do not penetrate the coating can be repaired using an automotive buffing compound. Deep scratches and heavy damage require a professional repair. Contact your dealer or a counter top repair professional for assistance in repairing deep scratches or other damage on your counter tops.

Interior Woodwork

Oiled and varnished woodwork or laminated, simulated wood can be cleaned with a damp cloth. For heavy duty cleaning, use a mixture of water and Murphy's Oil Soap or a solution of 10% white vinegar and water to clean the wood and wipe it dry with a clean towel. Apply a furniture polish to add luster and help to preserve the finish.

13.4 Windshield Hydraulic System

The windshield hydraulic pump operates at very high pressures and has specific maintenance requirements. You should perform all recommended maintenance according to the pump manufacturer's instructions.

Inspection and Routine Maintenance

- Check the hydraulic oil level frequently or immediately following the repair of a leaking fitting or any hydraulic system service. Use only hydraulic oil meeting the pump manufacturer's specifications. Refer to the pump manufacturer's operating and information manual for information on the operation and maintenance of the hydraulic system and oil specifications.

Notice:

Always check the hydraulic oil level with the windshield down to provide an accurate oil level reading and avoid overfilling the reservoir.

- Inspect all hoses, fittings, valves and seals for leaks and proper operation monthly.
- Periodically inspect all electrical connections, paying close attention to the heavy electrical wires, to make sure the connectors are corrosion free and tight. Corroded terminals should be thoroughly cleaned with sandpaper or replaced, tightened securely and sprayed with a metal and electrical protector. Coating the connectors with dielectric, Teflon or silicone grease will protect them and reduce future corrosion.

13.5 Engines & Fuel

Proper engine maintenance is essential to the proper performance and reliability of your outboard engines. Maintenance schedules and procedures are outlined in your engine owner's manual. They should be followed exactly.

If the boat is used in saltwater, flush the cooling systems after each daily use. To flush the systems when the boat is out of the water, follow the procedure outlined in your engine owner's manual.

Proper engine operation requires a good supply of clean, dry fuel. Improper marina fuel storage techniques, limited boat usage, etc. can cause the fuel to become contaminated.

The age of fuel can affect engine performance. Chemical changes occur as the fuel ages that can cause deposits and reduce the octane rating of the fuel. Severely degraded fuel can damage the engines and boat fuel tank and lines. Therefore, if your boat is not being run enough to require at least one full tank of fresh fuel a month, a fuel additive should be added to protect it from degradation. Your dealer or the engine manufacturer can provide additional information on fuel degradation and fuel stabilizers recommended for your engine.

In many states, most gasoline is blended with ethanol alcohol. Ethanol is a strong solvent and can absorb water during periods of storage. You should refer to the engine operating manual for information regarding alcohol blended fuels and how it affects the operation of your marine engine.

13.6 Bilge, Pumps & Components

To keep the bilge clean and fresh, it is recommended that you use a commercial bilge cleaner on a regular basis. Follow the directions carefully. All exposed pumps and metal components in the bilge should be sprayed periodically with a protector to reduce the corrosive effects of the high humidity always present in these areas.

Periodically check the bilge pumps and alarms for proper operation and clean debris from the strainers and automatic switches. Inspect all hoses, clamps and thru-hulls for leaks and tightness on a regular basis. Open and close all thru-hull valves at least once a month to keep them operating properly.

Frequently test the automatic switches for the bilge pumps and alarms for proper operation. Test the bilge pump automatic switches by using a garden hose to flood the bilge until the water level is high enough to activate the pumps. Test the high water alarm switch by simultaneously holding your fingers on the two recesses on the side of the switch until the alarm is activated.

13.7 Generator

The generator engine incorporates a pressure-type lubrication system and a fresh water cooled engine block which is thermostatically controlled. It requires regular oil changes as recommended by the manufacturer. The fuel filters should be changed at the same interval as the outboard engine filters.

The seawater cooling system on the generator is equipped with a sacrificial anode to protect cooling system components from galvanic corrosion. The anode should be inspected when the generator is serviced and replaced when it is 75% of its original size or at least once each year.

The most important factors to the generator's longevity are proper ventilation and maintenance of the fuel system, ignition system, cooling system, lubrication system and the AC alternator.

Maintenance schedules and procedures are outlined in your generator owner's manual. They should be followed exactly.

Notice:

The generator charges the house batteries just enough to compensate for the DC electrical current the engine requires to operate. Therefore, it is important to activate the battery charger to maintain the house and engine batteries whenever the generator is running.

13.8 Drainage System

It is essential that the following items be done periodically to maintain proper drainage of your boat:

- Clean the cockpit drains with a hose to remove debris that can block water drainage.
- Clean the hardtop leg drain holes. This is especially important just before winter lay-up.
- Flush all gravity drains with fresh water to keep them clean and free flowing.
- Clean and inspect the shower and cabin drain sump system. Remove accumulated debris and flush with fresh water. Frequently test the automatic pump switch for proper operation.
- Flush air conditioner condensation pans and drain hoses with fresh water at least once each season to remove mold and debris. This is particularly important because mold tends to accumulate in the condensation pan drain and, if it is not cleaned regularly, the drain can clog and flood the cabin or cockpit sole when the air conditioner is operating.
- Clean and flush the fishbox, baitwells, coolers and storage boxes with soap or a bilge cleaner and fresh water after each use to keep them clean and fresh.
- Operate the thru-hull valves once a month and service as required.
- Run all overboard pumps briefly at least once a month to keep them operating properly.

Notice:

All drains and pumps must be properly winterized before winter lay-up.

SEASONAL MAINTENANCE

14.1 Storage & Lay-up

Before Hauling:

- Pump out the head holding tank. Flush the holding tank using clean water, soap and a deodorizer. Pump out the cleaning solution.
- The fuel tank should be left nearly full to reduce condensation that can accumulate in the tank. Allow enough room in each tank for the fuel to expand without leaking out the vents. Moisture from condensation in the fuel tank can reach such concentrations that it becomes heavy enough to settle out of the fuel to the bottom of the tank. Since fuel pickup tubes are located near the bottom of the tank, this accumulated moisture can cause the engines to run poorly or not at all after extended storage.

Chemical changes also occur as the gasoline ages that can cause deposits and varnish in the fuel system as well as reduce the octane rating of the fuel. Severely degraded fuel can damage the engines and boat fuel tank and lines. Therefore, if your boat is not being run enough to require at least one full tank of fresh fuel a month or during winter storage, a fuel stabilizer should be added to the gasoline to help protect the fuel system from these problems. Operate the boat for at least 15

minutes after adding the stabilizer to allow the treated fuel to reach the engines. Yamaha recommends using Yamaha Fuel Conditioner and Stabilizer for their engines.

Your dealer or the engine manufacturer can provide additional information on fuel degradation and fuel stabilizers recommended for your engines. For more recommendations for your specific area, check with your local Everglades dealer.

- Drain water from the fresh water system.
- Consult the engine owner's manual for detailed information on preparing the engines for storage.

Lifting

It is essential that care be used when lifting your boat. Make sure the spreader bar at each sling is at least as long as the distance across the widest point of the boat that the sling will surround. Put the slings in position. Sling labels on the gunnels just above the rubrail identify the correct position for the lifting slings. The fore and aft slings should be tied together to prevent the slings from sliding on the hull.



Sling Locations



CAUTION



BOATS CAN BE DAMAGED FROM IMPROPER LIFTING AND TRANSPORTING WITH FORK LIFTS. CARE AND CAUTION MUST BE EXERCISED WHEN TRANSPORTING A BOAT WITH A FORK LIFT. NEVER HOIST THE BOAT WITH A SUBSTANTIAL AMOUNT OF WATER IN THE BILGE.

SEVERE GEL COAT CRACKING OR MORE SERIOUS HULL DAMAGE CAN OCCUR DURING HAULING AND LAUNCHING IF PRESSURE IS CREATED ON THE GUNWALES (SHEER) BY THE SLINGS. FLAT, WIDE BELTING SLINGS AND SPREADERS LONG ENOUGH TO KEEP PRESSURE FROM THE GUNWALES ARE ESSENTIAL. DO NOT ALLOW ANYONE TO HAUL YOUR BOAT WHEN THE SPREADERS ON THE LIFT ARE NOT WIDE ENOUGH TO TAKE THE PRESSURE OFF THE GUNWALES.

- Make sure the engines are in the down position.
- The cradle or lift must be in the proper fore and aft position to properly support the hull. When the cradle or lift is in the correct location, the bunks should match the bottom of hull and should not be putting pressure on the lifting strakes.



CAUTION



BOATS HAVE BEEN DAMAGED BY TRAILERS, LIFTS AND CRADLES THAT DON'T PROPERLY SUPPORT THE HULL. ALWAYS MAKE SURE THE BUNKS AND ROLLERS ARE ADJUSTED SO THEY ARE NOT PUTTING PRESSURE ON THE LIFTING STRAKES AND ARE PROVIDING ENOUGH SUPPORT FOR THE HULL. HULL DAMAGE RESULTING FROM IMPROPER CRADLE OR TRAILER SUPPORT IS NOT COVERED BY THE EVERGLADES WARRANTY.

Supporting The Boat For Storage

A trailer, elevating lift, well-made cradle or proper blocking is the best support for your boat during storage.

When storing the boat on a trailer for a long period:

- Make sure the trailer is large enough to properly support your boat and that it is rated to support the weight.
- Make sure the trailer is on a level surface and the bow is high enough so that water will drain from the bilge and cockpit.
- Make sure the engines are in the down position.
- The trailer must properly support the hull. The bunks and rollers should match the bottom of the hull and should not be putting pressure on the lifting strakes.
- Make sure the hitch is properly supported.
- Check the tires once each season. Add enough air for the correct amount of inflation for the tires as necessary.

Notice:

Read the owner's manual for the trailer for the correct amount of inflation for the tires.

When storing the boat on a lift or cradle:

- The cradle must be specifically for boat storage.
- Make sure the cradle or lift is well supported with the bow high enough to provide proper drainage of the bilge and cockpit.

When supporting the boat with blocking:

- Make sure the boat is blocked on a level surface and the bow is high enough so that water will drain from the bilge and cockpit.
- Make sure the keel is supported with large, solid wood blocks in at least three points.
- Use at least three heavy duty jacks on each side of the hull and make sure the boat is level from side to side. The jacks must be on a solid surface like packed gravel, concrete or pavement. All of the supports must be set up properly to prevent the boat from shifting while it is in storage.

Preparing The Boat For Storage:

- Remove the bilge drain plug, if installed.
- Thoroughly wash the fiberglass exterior, especially the antifouling portion of the bottom. Remove as much marine growth as possible. Lightly wax the exterior fiberglass components.
- Remove all oxidation from the exterior hardware and apply a light film of moisture displacing lubricant, wax or a metal protector.
- Remove propellers and grease the propeller shafts using light waterproof grease.

Seasonal Maintenance

- Remove the batteries and store in a cool place. Clean using clear, clean water. Be sure the batteries have sufficient water and clean terminals. Keep the batteries charged and safe from freezing throughout the storage period.

Notice:

Refer to the Electrical System chapter, for information on the maintenance of the AC and DC electrical systems.

- Coat all faucets and exposed electrical components in the cabin and cockpit with a protecting oil.
- Clean out, totally drain and completely dry the fish boxes, coolers, sinks and baitwells.
- Thoroughly clean the interior of the boat. Vacuum all carpets and dry clean drapes and upholstery.
- Remove cushions and open as many locker doors as possible. Leaving as many of these areas open as possible will improve the boat's ventilation during the storage period.

Notice:

It is recommended that a mildew preventer be hung in the cabin before it is closed for storage.

- Clean the exterior upholstery with a good vinyl cleaner and dry thoroughly. Spray the weather covers and boat upholstery with a spray disinfectant. Enclosed areas such as the shower basin, storage locker areas, etc. should also be sprayed with this disinfectant.

14.2 Winterizing Fresh Water System

The entire fresh water system must be completely drained. Disconnect all hoses, check valves, etc. and blow all the water from the system. Make sure the water heater, filters and fresh water tank are completely drained. Use only very low air pressure when doing this to prevent possible system damage. Because of the check valve mechanism built in the pump, blowing the lines will not remove the water from the fresh water pump. Remove the inlet and outlet hoses on the pump. Turn the pump on and allow it to pump out any remaining water...about a cupful. A recommended alternative to the above-mentioned procedure is the use of commercially available non toxic, fresh water

system antifreeze. After draining the fresh water tank, lines, filters and water heater, pour the antifreeze mixture into the fresh water tank, prime and operate the pump until the mixture flows from all fresh water faucets. Be sure to open all hot and cold water faucets, including the fresh water shower in the head compartment, anchor locker and cockpit washdown hoses, cockpit shower and the faucet in the mezzanine. Make sure antifreeze has flowed through all of the fresh water drains.

The shower/cabin sink drain system must be properly winterized. Clean debris from the drain and sump and flush for several minutes with fresh clean water. After the system is clean, pump the drain sump as dry as possible. Then pour a potable water antifreeze mixture into the shower and cabin sink drains until antifreeze has been pumped through the entire system and out of the thru-hull.

For additional information refer to the Fresh Water System and Drainage System chapters.

Raw Water System

Completely drain the raw water systems including the sea strainers in the aft systems compartment bilge. Disconnect all hoses and blow the water from the system. Use only very low air pressure when doing this to prevent possible system damage. Because of the check valve mechanism built in the raw water washdown pump, blowing the lines will not remove the water from the raw water pump. Remove the inlet and outlet hoses on the pump. Turn the pump on and allow it to pump out any remaining water...about a cupful.

A recommended alternative to the above-mentioned procedure is the use of commercially available nontoxic, potable water system antifreeze. If potable water antifreeze is used, pour the mixture into a pail and put the raw water intake lines into the solution. Run the pumps one at a time until the antifreeze solution is visible at all raw water faucets and discharge fittings and drains. Be sure antifreeze has flowed through all of the raw water drains.

Make sure all the water is removed from the fish-boxes, coolers and baitwells. Also make sure the drains are clear and free flowing.

Refer to the Raw Water System chapter for additional information on the raw water system.

Marine Toilet

The marine toilet must be properly winterized by following the manufacturer's winterizing instructions in the marine toilet owner's manual. Drain the intake and discharge hoses completely using low air pressure if necessary. The head holding tank and overboard discharge pump must be pumped dry and one or two gallons of potable water antifreeze poured into the tank through the deck waste pump out fitting. After antifreeze has been added to the holding tank, open the overboard discharge valve and activate the overboard macerator pump until the antifreeze solution is visible at the discharge thru-hull.

Notice:

Make sure you follow the marine toilet manufacturer's winterizing instructions exactly.

Bilge

Coat all metal components, wire busses and connector plugs in the bilge with a protecting oil. It is also important to protect all strainers, seacocks and steering components. The bilge pumps and bilge pump lines must be completely free of water and dried out when the boat is laid-up for the winter in climates where freezing occurs. Compartments in the bilge that will not drain completely should be pumped out and then sponged until completely free of water. Dry the hull bilge and self-bailing cockpit troughs. Water freezing in these areas could cause damage.

Air Conditioners

Disconnect and drain the seawater pump intake and discharge hoses. Remove all water from the sea strainer and thru-hull fitting. Blow the water from the system. Use only very low air pressure when doing this to prevent possible system damage.

The drain sump system must be properly winterized. Clean debris from the drain and sump and flush for several minutes with fresh clean water. After the system is clean, pump the drain sump as dry as possible. Then pour a potable water antifreeze mixture into the air conditioning condensation pan until antifreeze has been pumped through the entire system and out of the thru-hull. The air conditioning system, fresh water shower and cabin sink drains share the same sump system.

The air conditioner components must be properly winterized by following winterizing procedure in the manufacturer's owner's manual.

Notice:

The air conditioning, refrigerator/freezer, marine head and steering systems have specific lay up requirements. Please refer to their owner's manuals for recommended winterizing procedures.

SeaKeeper Raw Water Cooling System.

The SeaKeeper stabilization system has specific lay up and winterizing procedures. Refer to the SeaKeeper's manual and/or contact your Everglades dealer for recommended winterizing procedures.

Generator Raw Water System

Drain the sea strainer, heat exchanger and raw water supply and discharge lines for the generator seawater supply pump. Make sure all seawater has drained from the exhaust system. The generator muffler has a drain plug that must be removed to properly drain the muffler. Once this is accomplished, pour a non toxic marine engine antifreeze mixture into a large pail and put the seawater intake line into the solution. Run the generator until the antifreeze solution is visible at the exhaust port, then shut the engine off. You should refer to the generator owner's manual or contact your dealer for specific instructions on winterizing your generator.

Notice:

Properly winterize the engines, generator and fuel system by following the engine manufacturer's winterizing procedures located in your engine owner's manuals or contact an Everglades dealer.

Outboard Engines

The engines should be flushed with fresh water for at least 15 minutes prior to winter storage. This will remove salt, sand and other contaminants that can damage the engine. It is also important to "Fog" the cylinders, change the gear oil and change the oil. Coat each engine with a protector, wax the exterior and properly store and charge the batteries. You should refer to the engine owner's manual or contact your dealer for specific instructions on winterizing your engines.

Notice:

Properly winterize the engines and fuel system by following the engine manufacturer's winterizing procedures located in your engine owner's manuals or contact an Everglades dealer.

Seasonal Maintenance

Hardtop



It is imperative that all drain holes in the legs are open and that the legs are completely free of water. Remove the canvas and thoroughly clean and store in a safe, dry place. Remove all electronics. Coat all wire connectors and bus bars in the helm compartment with a protecting oil.

Clean the aluminum frame with soap and water and dry thoroughly. Apply an aluminum metal protector to the entire frame on anodized aluminum to reduce corrosion and pitting. Apply an automotive or boat wax to powder coated aluminum to protect it during storage periods.

Towers and Upper Helm Station

It is imperative that all drain holes in the tower and hardtop legs are open and completely free of water. Remove the tower sunshade, if installed and belly band or removable cushions. Then thoroughly clean and store in a safe, dry place. Remove all electronics. Coat all wire connectors and bus bars in the helm compartment with a protecting oil. Cover the Upper helm station with a tarp and secure it properly.



Clean the aluminum frame with soap and water and dry thoroughly. Apply an aluminum metal protector to anodized aluminum to reduce corrosion and pitting. Apply an automotive or boat wax to powder coated aluminum to protect it during storage periods.

	CAUTION	
<p>ALWAYS MAKE SURE THE LEG DRAIN HOLES ARE CLEAR WHEN THE BOAT IS LAID UP FOR THE WINTER. WATER TRAPPED INSIDE THE HARDTOP OR TOWER LEGS COULD FREEZE AND CAUSE THE LEGS TO SPLIT.</p>		

Special Notes Prior To Winter Storage

If the boat will be in outside storage, properly support a storage cover and secure it over the boat. It is best to have a frame built over the boat to support the canvas. It should be a few inches wider than the boat so the canvas will clear the rails and allow passage of air. If this cover is fastened too tightly there will be inadequate ventilation and this can lead to mildew, moisture accumulation, etc. It is essential to fasten the canvas down securely so that the wind cannot remove it or cause chafing of the hull superstructure. Do not store the boat in a damp storage enclosure. Excessive dampness can cause electrical problems, corrosion and excessive mildew.

Whenever possible, do not use the weather enclosure or sunshade in place of the winter storage cover. The life of these canvases may be significantly shortened if exposed to harsh weather elements for long periods.



	CAUTION	
<p>PLACING AN ELECTRIC OR FUEL BURNING HEATING UNIT IN THE BILGE AREA CAN BE POTENTIALLY HAZARDOUS AND IS NOT RECOMMENDED.</p>		

Proper storage is very important to prevent serious damage to the boat. If the boat is to be stored indoors, make sure the building has enough ventilation. It is very important that there is enough ventilation both inside the boat and around the boat.

Notice:

If the boat is to be stored indoors or outdoors, open all interior drawers, clothes lockers, cabinets and doors a little. If possible, remove the upholstery, mattresses, clothing and rugs. Then hang a commercially available mildew protector in the interior compartments.



14.3 Recommissioning

 **WARNING** 



DO NOT OPERATE THE BOAT UNLESS IT IS COMPLETELY ASSEMBLED. KEEP ALL FASTENERS TIGHT. KEEP ADJUSTMENTS ACCORDING TO SPECIFICATIONS.

Notice:

It is important and recommended that the fitting out procedure for the marine gear be done by a qualified service person. Read the engine owner's manual for the recommended procedure.

 **CAUTION** 

BEFORE LAUNCHING THE BOAT, MAKE SURE THE HULL DRAIN PLUG IS INSTALLED.

 **WARNING** 

MAKE SURE THE GENERATOR MUFFLER HAS NOT BEEN DAMAGED DURING WINTER STORAGE AND THAT THE DRAIN PLUG IS INSTALLED AND PROPERLY TIGHTENED. LOOSE OR MISSING DRAIN PLUGS AND DAMAGED OR LEAKING MUFFLERS OR EXHAUST HOSES WILL ALLOW CARBON MONOXIDE, ENGINE GASES AND WATER INTO THE BILGE CREATING A POTENTIALLY HAZARDOUS CONDITION.

Reactivating The Boat After Storage:

- Charge and install the batteries.
- Install the drain plug in the hull.
- Check the engines for damage and follow the manufacturer's instructions for recommissioning.
- Check the mounting bolts for the engines to make sure they are tight.
- Perform all routine maintenance.
- Check all hose clamps for tightness.
- Pump the antifreeze from the fresh and raw water systems and flush several times with fresh water. Make sure all antifreeze is flushed from the water heater and it is filled with fresh water before it is activated.
- Check and lubricate the steering system.

- Clean and wash the boat.
- Install all upholstery, cushions and canvas.

After Launching:

- Carefully check all water systems and the engine bolts for leaks. Operate each system one at a time checking for leaks and proper operation.
- Check the bilge pump manual and automatic switches.
- When each engine starts, check the cooling system port below the engine cowling for a strong stream of water. This ensures that the cooling pump is operating.
- Carefully monitor the gauges and check for leakage and abnormal noises.
- Operate the boat at slow speeds until the engine temperature stabilizes and all systems are operating normally.
- Start the generator and monitor the exhaust port for a steady stream of water. It may take 20 or 30 seconds for the muffler to fill and for water to appear at the port. This ensures that the cooling pump is operating. Carefully inspect the generator and all hoses for leaks, paying particular attention to the muffler and exhaust hoses. Any leak, no matter how minor must be corrected immediately.
- Once the generator is started and operating normally, activate the air conditioner and monitor the outlet port for a steady stream of water. It may take 20 or 30 seconds for the sea strainer and system to fill and for water to appear at the port. This ensures that the cooling pump is properly primed and operating. Carefully inspect all hoses for leaks, paying particular attention to the hoses below the waterline and those connected to the air conditioning system.
- If the pump runs but no water is visible at the outlet port after 45 seconds the air conditioning cooling pump may be air locked. The intake for the raw water manifold is equipped with a scoop and ball valve. Make sure the valve is open and run the boat at or above 15 M.P.H. for several minutes. The water pressure from the scoop will force the trapped air through the pump and allow it to prime. If this procedure doesn't work, contact your Everglades dealer.

GLOSSARY OF TERMS

Aft: In, near or toward the stern of a boat.

Aground: A boat stuck on the bottom.

Amidships: In or toward the part of a boat midway between the bow and stern.

Anchor: A specially shaped heavy metal device designed to dig efficiently into the bottom under a body of water and hold a boat in place.

Anchorage: An area specifically designated by governmental authorities in which boats may anchor.

Ashore: On shore.

Astern: Behind the boat, to move backwards.

Athwartship: At right angles to the center line of the boat.

Barnacles: Small, hard-shelled marine animals which are found in salt water attached to pilings, docks and bottoms of boats.

Beam: The breadth of a boat usually measured at its widest part.

Bearing: The direction of an object from the boat, either relative to the boat's direction or to compass degrees.

Berth: A bunk or a bed on a boat.

Bilge: The bottom of the boat below the flooring.

Bilge Pump: A pump that removes water that collects in the bilge.

Boarding: Entering or climbing into a boat.

Boarding Ladder: Set of steps temporarily fitted over the side of a boat to assist persons coming aboard.

Boat Hook: Short shaft of wood or metal with a hook fitting at one end shaped to aid in extending one's reach from the side of the boat.

Bow: The front end of a boat's hull

Bow Line: A line that leads forward from the bow of the boat.

Bow Rail: Knee high rails of solid tubing to aid in preventing people from falling overboard.

Bridge: The area from which a boat is steered and controlled.

Bridge Deck: A deck forward and usually above the cockpit deck.

Broach: When the boat is sideways to the seas and in danger of capsizing; a very dangerous situation that should be avoided.

Bulkhead: Vertical partition or wall separating compartments of a boat.

Cabin: Enclosed superstructure above the main deck level.

Capsize: When a boat lays on its side or turns over.

Chock: A deck fitting, usually of metal, with inward curving arms through which mooring or anchor lines are passed so as to lead them in the proper direction both on board and off the boat.

Cleat: A deck fitting, usually of metal with projecting arms used for securing anchor and mooring lines.

Closed Cooling System: A separate supply of fresh water that is used to cool the engine and circulates only within the engine.

Coaming: A vertical piece around the edges of cockpit, hatches, etc. to stop water on deck from running below.

Cockpit: An open space, usually in the aft deck, outside of the cabin.

Companionway: Opening in the deck of a boat to provide access below.

Compartment: The interior of a boat divided off by bulkheads.

Cradle: A framework designed to support a boat as she is hauled out or stored.

Cutlass Bearing: A rubber bearing in the strut that supports the propeller shaft.

Glossary of Terms

D**eck:** The floor-like platform of a boat that covers the hull.

Displacement: The volume of water displaced by the hull. The displacement weight is the weight of this volume of water.

Draft: The depth of water a boat needs to float.

Dry Rot: A fungus attack on wood areas.

Dry-dock: A dock that can be pumped dry during boat construction or repair.

E**lectrical Ground:** A connection between an electrical connector and the earth.

Engine Beds: Sturdy structural members running fore and aft on which the inboard engines are mounted.

EPIRB: Emergency Position Indicating Radio Beacon. Operates as a part of a worldwide satellite distress system.

Even Keel: When a boat floats properly as designed.

F**athom:** A measure of depth. One Fathom = 6 feet.

Fender: A soft object of rubber or plastic used to protect the topsides from scarring and rubbing against a dock or another vessel.

Fend off: To push or hold the boat off from the dock or another boat.

Flying Bridge: A control station above the level of the deck or cabin.

Flukes: The broad portions of an anchor which dig into the ground.

Fore: Applies to the forward portions of a boat near the bow.

Foundering: When a boat fills with water and sinks.

Freeboard: The height from the waterline to the lowest part of the deck.

G**alley:** The kitchen of a boat.

Grab Rail: Hand-hold fittings mounted on cabin tops or sides for personal safety when moving around the boat, both on deck and below.

Ground Tackle: A general term including anchors, lines and other gear used in anchoring.

Grounds: A boat touches the bottom.

Gunwale: The upper edge of a boat's side.

H**and Rail:** Rail mounted on the boat, for grabbing with your hand, to steady you while walking about the boat.

Harbor: An anchorage which provides reasonably good protection for a boat, with shelter from wind and sea.

Hatch: An opening in the deck with a door or lid to allow for access down into a compartment of a boat.

Head: A toilet on a boat.

Heat Exchanger: Used to transfer the heat that is picked up by the closed cooling system to the raw cooling water.

Helm: The steering and control area of a boat.

Hull: The part of the boat from the deck down.

I**nboard:** A boat with the engine mounted within the hull of the boat. Also refers to the center of the boat away from the sides.

Inboard/outboard: Also stern drive or I/O. A boat with an inboard engine attached to an outboard drive unit.

K**eel:** A plate or timber plate running lengthwise along the center of the bottom of a boat.

Knot: Unit of speed indicating nautical miles per hour. 1 knot = 1 nautical mile per hour (1.15 miles per hour). A nautical mile is equal to one minute of latitude: 6076 feet. Knots times 1.15 equals miles per hour. Miles per hour times .87 equals knots.

L**ay-up:** To decommission a boat for the winter (usually in northern climates).

Leeward: The direction toward which the wind is blowing.

Glossary of Terms

Length On The Waterline (l.w.l.): A length measurement of a boat at the waterline from the stern to where the hull breaks the water near the bow.

Limber Hole: A passage cut into the lower edges of floors and frames next to the keel to allow bilge water to flow to the lowest point of the hull where it can be pumped overboard.

Line: The term used to describe a rope when it is on a boat.

Lists: A boat that inclines to port or starboard while afloat.

L.O.A.: Boat length overall.

Locker: A closet, chest or box aboard a boat.

Loran: An electronic navigational instrument which monitors the boat's position using signals emitted from pairs of transmitting stations.

Lunch hook: A small light weight anchor typically used instead of the working anchor. Normally used in calm waters with the boat attended.

Midships: The center of the boat.

Marina: A protected facility primarily for recreational small craft.

Marine Ways or Railways: Inclined planes at the water's edge onto which boats are hauled.

Moored: A boat secured with cables, lines or anchors.

Mooring: An anchor permanently embedded in the bottom of a harbor that is used to secure a boat.

Nautical Mile: A unit of measure equal to one minute of latitude. (6076 feet)

Nun Buoy: A red or red-striped buoy of conical shape.

Outboard: A boat designed for an engine to be mounted on the transom. Also a term that refers to objects away from the center line or beyond the hull sides of a boat.

Pad Eye: A deck fitting consisting of a metal eye permanently secured to the boat.

Pier: A structure which projects out from the shoreline.

Pile or Piling: A long column driven into the bottom to which a boat can be tied.

Pitching: The fore and aft rocking motion of a boat as the bow rises and falls.

Pitch: The measure of the angle of a propeller blade. Refers to the theoretical distance the boat travels with each revolution of the propeller.

P.F.D: Personal Flotation Device.

Port: The left side of the boat when facing the bow.

Porthole (port): The opening in the side of a boat to allow the admittance of light and air.

Propeller: A device having two or more blades that is attached to the engine and used for propelling a boat.

Propeller Shaft: Shaft which runs from the back of the engine gear box, aft, through the stuffing box, shaft log, struts and onto which the propeller is attached.

Pyrotechnic Distress Signals: Distress signals that resemble the brilliant display of flares or fireworks.

Raw Water Cooled: Refers to an engine cooling system that draws seawater in through a hull fitting or engine drive unit, circulates the water in the engine and then discharges it overboard.

Reduction Gear: Often combined with the reverse gear so that the propeller turns at a slower rate than the engine.

Reverse Gear: Changes the direction of rotation of the propeller to provide thrust in the opposite direction for stopping the boat or giving it sternway.

Roll: A boat's sideways rotational motion in rough water.

Rope Locker: A locker, usually located in the bow of a boat, used for stowing the anchor line or chain.

Rubrail: Railing (often rubber or hard plastic) that runs along the boat's sheer to protect the hull when coming alongside docks, piers or other boats.

Rudder: A moveable flat surface that is attached vertically at or near the stern for steering.

Sea anchor: An anchor that does not touch the bottom. Provides drag to hold the bow in the most favorable position in heavy seas.

Glossary of Terms

Scupper: An opening in the hull side or transom of the boat through which water on deck or in the cockpit is drained overboard.

Seacock: Safety valves installed just inside the thru-hull fittings and ahead of the piping or hose running from the fittings.

Shaft Log: Pipe through which the propeller shaft passes.

Sheer: The uppermost edge of the hull.

Sling: A strap which will hold the boat securely while being lifted, lowered or carried.

Slip: A boat's berth between two pilings or piers.

Sole: The deck of a cockpit or interior cabin.

Spring Line: A line that leads from the bow aft or from the stern forward to prevent the boat from moving ahead or astern.

Starboard: The right side of a boat when facing the bow.

Steerageway: Sufficient speed to keep the boat responding to the rudder or drive unit.

Stem: The vertical portion of the hull at the bow.

Stern: The rear end of a boat.

Stow: To pack away neatly.

Stringer: Longitudinal members fastened inside the hull for additional structural strength.

Strut: Mounted to the hull which supports the propeller shaft in place.

Strut Bearing: See "cutlass bearing."

Stuffing Box: Prevents water from entering at the point where the propeller shaft passes through the shaft log.

Superstructure: Something built above the main deck level.

Swamps: When a boat fills with water from over the side.

Swimming Ladder: Much the same as the boarding ladder except that it extends down into the water.

Taffrail: Rail around the rear of the cockpit.

Thru-hull: A fitting used to pass fluids (usually water) through the hull surface, either above or below the waterline.

Topsides: The side skin of a boat between the waterline or chine and deck.

Transom: A flat stern at right angles to the keel.

Travel Lift: A machine used at boat yards to hoist boats out of and back into the water.

Trim: Refers to the boat's angle or the way it is balanced.

Trough: The area of water between the crests of waves and parallel to them.

Twin-Screw Craft: A boat with two propellers on two separate shafts.

Underway: When a boat moves through the water.

Wake: Disrupted water that a boat leaves astern as a result of its motion.

Wash: The flow of water that results from the action of the propeller or propellers.

Waterline: The plane of a boat where the surface of the water touches the hull when it is afloat on even keel.

Watertight Bulkhead: Bulkheads secured so tightly so as not to let water pass.

Wharf: A structure generally parallel to the shore.

Working Anchor: An anchor carried on a boat for most normal uses. Refers to the anchor used in typical anchoring situations.

Windlass: A winch used to raise and lower the anchor.

Windward: Toward the direction from which the wind is coming.

Yacht Basin: A protected facility primarily for recreational small craft.

Yaw: When a boat runs off her course to either side.

Appendix C:

DEPARTMENT OF TRANSPORTATION U.S. COAST GUARD CG-3865 (Rev. 9/95)		BOATING ACCIDENT REPORT		FORM APPROVED OMB NO. 2115-0010		
STATE ASSIGNED CASE NO. _____						
THE OPERATOR/OWNER OF A VESSEL USED FOR RECREATIONAL PURPOSES IS REQUIRED TO FILE A REPORT IN WRITING WHENEVER AN ACCIDENT RESULTS IN: LOSS OF LIFE OR DISAPPEARANCE FROM A VESSEL; AN INJURY WHICH REQUIRES MEDICAL TREATMENT BEYOND FIRST AID; OR PROPERTY DAMAGE IN EXCESS OF \$2000 OR COMPLETE LOSS OF THE VESSEL. REPORTS IN DEATH AND INJURY CASES MUST BE SUBMITTED WITHIN 48 HOURS. REPORTS IN OTHER CASES MUST BE SUBMITTED WITHIN 10 DAYS. REPORTS MUST BE SUBMITTED TO THE REPORTING AUTHORITY IN THE STATE WHERE THE ACCIDENT OCCURRED. THIS FORM IS PROVIDED TO ASSIST THE OPERATOR IN FILING THE REQUIRED WRITTEN REPORT.						
COMPLETE ALL BLOCKS (INDICATE THOSE NOT APPLICABLE BY "NA")						
ACCIDENT DATA						
DATE OF ACCIDENT	TIME	AM PM	NAME OF BODY OF WATER	LOCATION (GIVE LOCATION PRECISELY)		
NUMBER OF VESSELS INVOLVED	NEAREST CITY OR TOWN		COUNTY	STATE	ZIP CODE	
WEATHER (CHECK ALL APPLICABLE) [] CLEAR [] RAIN [] CLOUDY [] SNOW [] FOG [] HAZY	WATER CONDITIONS [] CALM (WAVES LESS THAN 6") [] CHOPPY (WAVES 6" TO 2') [] ROUGH (WAVES 2' TO 6') [] VERY ROUGH (GREATER THAN 6') [] STRONG CURRENT		TEMPERATURE (ESTIMATE) AIR _____ °F WATER _____ °F	WIND [] NONE [] LIGHT (0-6 MPH) [] MODERATE (7-14 MPH) [] STRONG (15-25 MPH) [] STORM (OVER 25 MPH)		
VISIBILITY DAY NIGHT [] GOOD [] [] FAIR [] [] POOR []			NAME OF OPERATOR			
OPERATOR TELEPHONE NUMBER ()			OPERATOR ADDRESS			
OPERATOR TELEPHONE NUMBER ()	DATE OF BIRTH MO DAY YR	OPERATOR'S EXPERIENCE [] NONE [] UNDER 100 HOURS [] > 100 HOURS		INSTRUCTION IN BOATING SAFETY [] STATE COURSE [] U.S. POWER SQUADRON [] USCG AUXILIARY [] AMERICAN RED CROSS [] NONE		
[] MALE [] FEMALE	NAME OF OWNER					
OWNER TELEPHONE NUMBER ()			OWNER ADDRESS			
OWNER TELEPHONE NUMBER ()	NUMBER OF PEOPLE ON BOARD	NUMBER OF PEOPLE BEING TOWED		RENTED BOAT? [] YES [] NO		
BOAT NO. 1 (THIS VESSEL)						
BOAT REGISTRATION OR DOCUMENTATION NUMBER		STATE	HULL IDENTIFICATION NUMBER		BOAT NAME	
BOAT MANUFACTURER		LENGTH	MODEL		YEAR BUILT	
TYPE OF BOAT [] OPEN MOTORBOAT [] CABIN MOTORBOAT [] AUXILIARY SAIL [] SAIL (ONLY) [] ROWBOAT [] CANOE/KAYAK [] PERSONAL WATERCRAFT [] PONTOON BOAT [] HOUSEBOAT [] OTHER (SPECIFY)	HULL MATERIAL [] WOOD [] ALUMINUM [] STEEL [] FIBERGLASS [] RUBBER/VINYL/CANVAS [] RIGID HULL INFLATABLE [] OTHER (SPECIFY)		ENGINE [] OUTBOARD [] INBOARD [] INBOARD- STERNDRIVE (I/O) [] AIRBOAT	PROPULSION [] PROPELLER [] WATER JET [] AIR THRUST [] MANUAL [] SAIL	PERSONAL FLOTATION DEVICES (PFDS): WAS BOAT ADEQUATELY EQUIPPED WITH COAST GUARD APPROVED PFDS? [] YES [] NO WERE PFDS ACCESSIBLE? [] YES [] NO	
FUEL [] GASOLINE [] DIESEL [] ELECTRIC		NUMBER OF ENGINES TOTAL HORSEPOWER		FIRE EXTINGUISHERS ON BOARD? [] YES [] NO USED? [] YES [] NO		
OPERATION AT TIME OF ACCIDENT (CHECK ALL APPLICABLE) [] CRUISING [] CHANGING DIRECTION [] CHANGING SPEED [] DRIFTING [] TOWING [] BEING TOWED [] ROWING/PADDLING [] SAILING [] LAUNCHING [] DOCKING/UNDOCKING [] AT ANCHOR [] TIED TO DOCK/MOORED [] OTHER (SPECIFY)		ACTIVITY AT TIME OF ACCIDENT (CHECK ANY IF APPLICABLE) [] FISHING [] TOURNAMENT [] HUNTING [] SWIMMING/DIVING [] MAKING REPAIRS [] WATERSKIING/TUBING/ETC. [] RACING [] WHITEWATER SPORTS [] FUELING [] STARTING ENGINE [] NON-RECREATIONAL [] OTHER (SPECIFY)		TYPE OF ACCIDENT [] GROUNDING [] CAPSIZING [] FLOODING/SWAMPING [] SINKING [] FIRE OR EXPLOSION (FUEL) [] FIRE OR EXPLOSION (OTHER) [] SKIER MISHAP [] COLLISION WITH VESSEL [] COLLISION WITH FIXED OBJECT [] COLLISION WITH FLOATING OBJ. [] FALLS OVERBOARD [] FALLS IN BOAT [] STRUCK BY BOAT [] STRUCK BY MOTOR/PROPELLER [] STRUCK SUBMERGED OBJECT [] OTHER (SPECIFY)		WHAT CONTRIBUTED TO ACCIDENT? (CHECK ALL APPLICABLE) [] WEATHER [] EXCESSIVE SPEED [] IMPROPER LOOKOUT [] RESTRICTED VISION [] OVERLOADING [] IMPROPER LOADING [] HAZARDOUS WATERS [] ALCOHOL USE [] DRUG USE [] HULL FAILURE [] MACHINERY FAILURE [] EQUIPMENT FAILURE [] OPERATOR INEXPERIENCE [] OPERATOR INATTENTION [] CONGESTED WATERS [] PASSENGER/SKIER BEHAVIOR [] DAM/LOCK [] OTHER (SPECIFY)
ESTIMATED SPEED [] NONE [] UNDER 10 MPH [] 10 - 20 MPH [] 21 - 40 MPH [] OVER 40 MPH	[] HIT AND RUN					

Boating Accident Report

DECEASED (IF MORE THAN 2 FATALITIES, ATTACH ADDITIONAL FORMS)			
NAME OF VICTIM		ADDRESS OF VICTIM	
DATE OF BIRTH	[] MALE [] FEMALE	DEATH CAUSED BY	[] DROWNING [] OTHER [] DISAPPEARANCE
NAME OF VICTIM		ADDRESS OF VICTIM	
DATE OF BIRTH	[] MALE [] FEMALE	DEATH CAUSED BY	[] DROWNING [] OTHER [] DISAPPEARANCE
INJURED (IF MORE THAN 2 INJURIES, ATTACH ADDITIONAL FORMS)			
NAME OF VICTIM		ADDRESS OF VICTIM	
DATE OF BIRTH	MEDICAL TREATMENT BEYOND FIRST AID? [] YES [] NO ADMITTED TO HOSPITAL? [] YES [] NO	DESCRIBE INJURY	
WAS PFD WORN? [] YES [] NO	PRIOR TO ACCIDENT? [] YES [] NO	AS A RESULT OF ACCIDENT? [] YES [] NO	
WAS IT INFLATABLE? [] YES [] NO			
NAME OF VICTIM		ADDRESS OF VICTIM	
DATE OF BIRTH	MEDICAL TREATMENT BEYOND FIRST AID? [] YES [] NO ADMITTED TO HOSPITAL? [] YES [] NO	DESCRIBE INJURY	
WAS PFD WORN? [] YES [] NO	PRIOR TO ACCIDENT? [] YES [] NO	AS A RESULT OF ACCIDENT? [] YES [] NO	
WAS IT INFLATABLE? [] YES [] NO			
OTHER PEOPLE ABOARD THIS BOAT (IF MORE THAN 2 PEOPLE, ATTACH ADDITIONAL FORMS)			
NAME		ADDRESS	
DATE OF BIRTH	WAS PFD WORN? [] YES [] NO AS A RESULT OF ACCIDENT [] YES [] NO	PRIOR TO ACCIDENT? [] YES [] NO	WAS IT INFLATABLE? [] YES [] NO
NAME		ADDRESS	
DATE OF BIRTH	WAS PFD WORN? [] YES [] NO AS A RESULT OF ACCIDENT [] YES [] NO	PRIOR TO ACCIDENT? [] YES [] NO	WAS IT INFLATABLE? [] YES [] NO
BOAT NO. 2 (IF MORE THAN 2 VESSELS, ATTACH ADDITIONAL IDENTIFYING INFORMATION)			
NAME OF OPERATOR		OPERATOR ADDRESS	
OPERATOR TELEPHONE NUMBER ()		BOAT REGISTRATION OR DOCUMENTATION NUMBER	STATE
NAME OF OWNER		OWNER ADDRESS	
OWNER TELEPHONE NUMBER ()			
PROPERTY DAMAGE			
ESTIMATED AMOUNT: THIS BOAT AND CONTENTS:	OTHER BOAT(S) AND CONTENTS:	OTHER PROPERTY:	
\$	\$	\$	
DESCRIBE PROPERTY DAMAGED			
WITNESSES NOT ON THIS VESSEL			
NAME	ADDRESS	TELEPHONE NUMBER ()	
NAME	ADDRESS	TELEPHONE NUMBER ()	
PERSON COMPLETING REPORT			
NAME	ADDRESS	TELEPHONE NUMBER ()	
SIGNATURE	QUALIFICATION [] OPERATOR [] OWNER [] INVESTIGATOR [] OTHER	DATE SUBMITTED	
FOR AGENCY USE ONLY			
CAUSES BASED ON (CHECK ONE): [] THIS REPORT [] INVESTIGATION [] INVESTIGATION AND THIS REPORT [] OTHER			
NAME OF REVIEWING OFFICE	DATE RECEIVED	RECREATIONAL []	NON-REPORTABLE []
PRIMARY CAUSE	COMMERCIAL [] SECONDARY CAUSE		

Call the Coast Guard Infoline 1-800-368-5647 for information on **Federal Requirements for Recreational Boats**

Boating Accident Report

ACCIDENT DESCRIPTION

DESCRIBE WHAT HAPPENED (SEQUENCE OF EVENTS. INCLUDE FAILURE OF EQUIPMENT. INCLUDE A DIAGRAM IF NEEDED. CONTINUE ON ADDITIONAL SHEETS IF NECESSARY. INCLUDE ANY INFORMATION REGARDING THE INVOLVEMENT OF ALCOHOL AN/OR DRUGS IN CAUSING OR CONTRIBUTING TO THE ACCIDENT. INCLUDE ANY DESCRIPTIVE INFORMATION ABOUT THE USE OF PFD'S.)

An agency may not conduct or sponsor and a person is not required to respond to an information collection, unless it displays a currently valid OMB Control Number. The Coast Guard estimates that the average burden for this report form is 30 minutes. You may submit any comments concerning the accuracy of this burden estimate or any suggestions for reducing the burden to: Commandant (G-OPB-1), U.S. Coast Guard, Washington, DC 20593-0001 or Office of Management and Budget, Paperwork Reduction Project (2115-0010), Washington, DC 20503.

NOTES

FLOAT PLAN

Everglades recommends filling out a float plan each time you use your boat for an off-shore day trip or a long cruise. Leave this information with a responsible person ashore, like a close friend or relative that you know well.

1. Name of person reporting and telephone number.

2. Description of boat.
Type _____ Color _____ Trim _____
Registration No. _____ Length _____
Name _____ Make _____ Other Info _____
3. Engine type _____ H.P. _____
No. of Engines _____ Fuel Capacity _____
4. Survival equipment: (Check as appropriate)

<input type="checkbox"/> PFDS	<input type="checkbox"/> Flares	<input type="checkbox"/> Mirror
<input type="checkbox"/> Smoke Signals	<input type="checkbox"/> Flashlight	<input type="checkbox"/> Food
<input type="checkbox"/> Paddles	<input type="checkbox"/> Water	<input type="checkbox"/> Others
<input type="checkbox"/> Anchor	<input type="checkbox"/> Raft or Dinghy	<input type="checkbox"/> EPIRB
5. Radio Yes No Type _____
6. Automobile license _____
Type _____ Trailer License _____
Color _____ and make of auto _____
7. Persons aboard _____
Name _____ Age _____ Address & telephone No. _____

8. Do any of the persons aboard have a medical problem?
 Yes No If yes, what? _____
9. Trip Expectations: Leave at _____
From _____ Going to _____
Expect to return by _____ (time)
and no later than _____
10. Any other pertinent info. _____
11. If not returned by _____ (time)
call the COAST GUARD or (Local authority) _____
12. Telephone Numbers.

NOTES

TROUBLESHOOTING GUIDE

PROBLEM	CAUSE AND SOLUTION
CONTROL SYSTEMS	
<p>Hydraulic Steering is slow to respond & erratic and/or the steering wheel feels bumpy.</p>	<ul style="list-style-type: none"> • Steering system is low on fluid. Fill and bleed system. • Steering system has air in it. Fill and bleed system. • A component in the steering system is binding. Check and adjust or repair binding component. • Engine steering spindle is binding. Grease spindle.
<p>The boat wanders and will not hold a course at cruise speeds with hydraulic steering.</p>	<ul style="list-style-type: none"> • There could be air in the steering system. Fill & bleed the system. • The engines are not aligned properly. Align engines. • Engine steering spindle is binding. Grease spindle.
<p>Hydraulic Steering is unusually hard.</p>	<ul style="list-style-type: none"> • The fuse for the power steering circuit has blown. Replace the fuse. • An internal fuse in the power steering pump system has blown. Refer to the steering owners manual for fuse location and replace the fuse or contact your dealer for assistance. • A steering line is kinked or collapsed. Replace kinked or collapsed line.
<p>An engine will not start with the shift control lever in neutral.</p>	<ul style="list-style-type: none"> • The shift control lever is not in the neutral detent. Try moving the shift lever slightly. • There is a loose wire on the neutral safety switch in the control. Inspect wires and repair loose connections. • The starter or ignition switch is bad. • There is a problem with the electronic control system at the helm control, module or at the engine. Have the system serviced by a qualified marine technician.
PERFORMANCE PROBLEMS	
<p>Boat is sluggish and has lost speed & RPM.</p>	<ul style="list-style-type: none"> • The boat may be need to have marine growth cleaned from hull and running gear. • Propellers may be damaged & need repair. • Weeds or line around the propellers. Clean propellers. • Boat is overloaded. Reduce load. • Check for excessive water in the bilge. Pump out bilge & find & correct the problem. • One of the throttles is not responding properly and the engine is not getting full throttle. Have the throttle control system checked by a qualified marine technician. • Hull ventilation seacocks in bilge are closed. Open hull ventilation seacocks.
<p>The boat vibrates at cruising speeds.</p>	<ul style="list-style-type: none"> • Propellers may be damaged & need repair. • A propeller or propeller shaft is bent. Repair or replace damaged components. • The running gear is fouled by marine growth or rope. Clean running gear. • The engines are not trimmed properly. Trim engines.

Troubleshooting Guide

PROBLEM	CAUSE AND SOLUTION
ENGINE PROBLEMS	
<p>An engine is running too hot.</p>	<ul style="list-style-type: none"> • The engine raw water pick up strainer is clogged with marine growth. Clean pick up. • The engine raw water pump impeller is worn or damaged. Repair the pump. • The engine thermostat is faulty and needs to be replaced.
<p>An engine alternator is not charging properly.</p>	<ul style="list-style-type: none"> • The battery cable is loose or corroded. Clean and tighten battery cables. • The alternator is not charging and must be replaced. • The battery is defective. Replace the battery. • A Voltage Sensitive Relay in the charging system is not working properly. Replace defective VSR.
<p>An engine suddenly will not operate over 2000 RPM.</p>	<ul style="list-style-type: none"> • The engine emergency system has been activated. The on board computer has sensed a problem and has limited the RPM to protect the engine. Find & correct the problem. • The tachometer is bad and needs to be replaced. • A throttle control is not responding properly. Have the throttle setting checked by a qualified technician.
<p>An engine is losing RPM. The boat is not overloaded and the hull bottom and running gear are clean and in good condition.</p>	<ul style="list-style-type: none"> • The engine may be having a problem with a sticky Anti-siphon valve, located in the fuel line near the fuel tank, that is restricting the fuel flow. Remove & clean or replace the Anti-siphon valve. • The remote gasoline fuel filter could be dirty. Inspect and replace the fuel filter. • The primary fuel filter on the engine may be dirty. Inspect and replace the fuel filter. • The electronic engine control system on the engine is malfunctioning. Repair the engine control system. • The fuel injection system on the engine is malfunctioning. Repair the fuel injection system.

Troubleshooting Guide

PROBLEM	CAUSE AND SOLUTION
ACCESSORY PROBLEMS	
<p>A baitwell pump runs, but does not pump water.</p>	<ul style="list-style-type: none"> • The thru-hull valve is not open. Open valve. • The intake scoop strainer for the raw water system is clogged with weeds or debris. Back down the boat to clear debris or clean the scoop strainer. • There is an air lock in the system. Prime the system.
<p>The fresh water pump runs, but will not pump water.</p>	<ul style="list-style-type: none"> • The water tank is empty. Fill the tank. • The water pump strainer is clogged. Clean strainer. • The intake hose is damaged and sucking air. Replace or repair the hose. • The pump is defective. Repair or replace the pump.
<p>The fresh water pump fails to turn off after all outlets are closed.</p>	<ul style="list-style-type: none"> • There is a leak in a pressure line or outlet. Repair the leak. • There is an air leak in the intake line. Repair the air leak. • The pressure switch is defective. Replace the pressure switch. • The voltage to the pump is low. Check for corroded or loose wiring connections or low battery. • The strainer is clogged. Clean strainer. • The pump is defective. Repair or replace the pump.
<p>The raw water pump runs, but the pump will not pump water.</p>	<ul style="list-style-type: none"> • The thru-hull valve is not open. Open valve. • There is an air leak in the intake line. Repair the air leak. • The intake scoop strainer for the raw water system is clogged with weeds or debris. Back down the boat to clear debris or clean the scoop strainer. • The in-line sea strainer for the pump is clogged. Clean the sea strainer.
<p>The raw water or fresh water pump fails to turn off after all outlets are closed.</p>	<ul style="list-style-type: none"> • The intake hose is damaged and sucking air. Replace hose. • The pump is defective. Repair or replace the pump. • There is a leak in a pressure line or outlet. Repair the leak. • There is an air leak in the intake line. Repair the air leak. • The pressure switch is defective. Replace the pressure switch. • The voltage to the pump is low. Check for corroded or loose wiring connections or low battery.
<p>Reduction in water flow from a bilge pump.</p>	<ul style="list-style-type: none"> • The pump strainer is clogged. Clean strainer. • The pump is defective. Repair or replace the pump. • The discharge hose is pinched or clogged. Check discharge hose and clean or repair. • Low voltage to the pump. Check the battery and wire connections.

Troubleshooting Guide

PROBLEM	CAUSE AND SOLUTION
ACCESSORY PROBLEMS	
<p>The automatic switch on the bilge pump does not activate the pump .</p>	<ul style="list-style-type: none"> • The fuse or circuit breaker for the automatic switch has tripped or blown. Replace the fuse or reset the circuit breaker. • The battery is dead. Charge or replace the battery. • The pump impeller is jammed by debris. Clean pump impeller housing. • The wire connections in the bilge have corroded. Replace connectors and secure above the bilge waterline. • The automatic switch is defective. Replace the switch. • The pump is defective. Replace pump.
<p>The bilge pump will not run when the manual switch is activated.</p>	<ul style="list-style-type: none"> • The circuit breaker supplying the switch has tripped. Reset the circuit breaker. Replace if defective. • The battery switch is off. Turn on the battery switch. • The pump impeller is jammed by debris. Clean pump impeller housing. • The wire connections in the bilge have corroded. Replace connectors and secure above the bilge waterline. • The switch is defective. Replace the switch. • The pump is defective. Replace pump.
<p>Head will not flush.</p>	<ul style="list-style-type: none"> • The fuse for the head circuit is blown. Replace the fuse. • The holding tank is full. Pump out the holding tank. • There is bad connection at the head pump or the switch. Repair the connection. • The head pump is defective. Replace the pump.
<p>Excessive odor from marine head.</p>	<ul style="list-style-type: none"> • Back pressure in the holding tank. Pump out holding tank and clean the vent and vent hose. • No deodorizer in the holding tank. Add deodorizer to the holding tank each time it is pumped out. • The waste in the tank is over two weeks old. Pump the holding tank if it has contained waste for two weeks or more.
<p>Holding tank will not empty.</p>	<ul style="list-style-type: none"> • Holding tank vent is clogged. Clean the vent and vent hose. • There is a vacuum leak in the hose from the holding tank to the deck pump out fitting. Tighten loose fittings or replace damaged hoses.
<p>The air conditioner runs for a short time & then cuts out.</p>	<ul style="list-style-type: none"> • The intake scoop strainer for the raw water system is clogged with weeds or debris. Back down the boat to clear debris or clean the scoop strainer. • The air conditioner pump sea strainer is clogged. Clean the strainer. • The raw water supply thru hull valve is closed. Open the valve. • The raw water system is air-bound. Make sure the thru hull valve is open and run the boat above 15 m.p.h. The speed scoop on the thru hull fitting will force the air lock out of the system. • The air conditioner raw water pump is not pumping and needs to be repaired or replaced.

Troubleshooting Guide

PROBLEM	CAUSE AND SOLUTION
ACCESSORY PROBLEMS	
<p>The refrigerator compressor runs frequently and the house battery life seems shorter than it should be when the refrigerator is operating on DC power.</p>	<ul style="list-style-type: none"> • The thermostat in the refrigerator is set too cold. Check the temperature in the refrigerator and set the thermostat to a warmer setting if necessary. • The door gasket is dirty or moldy and not sealing properly. Clean or replace the door seal. • The house batteries are weak and not providing the proper voltage to the refrigerator compressor. Replace the batteries. • The refrigerator is defective. Replace the refrigerator.
<p>The carbon monoxide detector sounds the alarm when the engines or generator are running.</p>	<ul style="list-style-type: none"> • The canvas curtains are up and none of the forward facing vents are open, allowing carbon monoxide to accumulate in the cockpit and cabin. Open the windshield and side curtains to provide proper ventilation. • The boat is operating at slow speed and the wind is on the stern pushing CO into the cockpit and cabin. Increase boat speed or change heading if possible. • The carbon monoxide detector is defective and needs to be calibrated by the manufacturer or replaced. Have the boat checked by a professional before condemning the CO monitor.
<p>No AC power to cabin breaker panel and shore cord is properly connected.</p>	<ul style="list-style-type: none"> • The breaker at the shore outlet is off. Activate breaker. • The shore power cord is damaged or defective. Replace the cord. • The ELCI at the inlet connection has detected a fault in the electrical system and the breaker has tripped. Contact a qualified marine electrician to find and correct the problem.
<p>The cabin Main Breaker for AC Power trips when activating the system from shore power.</p>	<ul style="list-style-type: none"> • The AC accessory breakers are on and the power surge is tripping the breaker. Turn off all AC accessory breakers and reactivate main breaker. • The main breaker is defective. Contact a qualified marine electrician to replace the breaker.
<p>The cabin AC main breaker activates the panel but trips while using accessories.</p>	<ul style="list-style-type: none"> • There are too many AC accessories activated causing excess amperage draw. Manage AC accessory use to reduce excess amperage draw. • Voltage supplied from the shore outlet is low or high. Check the voltage. Contact the marina operator or qualified marine electrician to correct the problem. • The main breaker is defective. Contact a qualified marine electrician to replace the breaker.
<p>No AC power at cabin outlets</p>	<ul style="list-style-type: none"> • Outlet breaker in cabin AC panel is off. Activate breaker. • Ground fault interrupter has tripped. Push reset button on outlet to reset. • Accessory powered by the outlet has a fault that is tripping the interrupter. Turn the breaker in the cabin AC panel off and contact a qualified marine electrician to repair the defective accessory. Replace defective accessory. • The GFI outlet is defective. Contact a qualified marine electrician to replace the outlet.

Troubleshooting Guide

PROBLEM	CAUSE AND SOLUTION
ACCESSORY PROBLEMS	
The generator will not start.	<ul style="list-style-type: none">• House battery is not charged. Charge or replace battery.• The generator fuel supply valve is off. Turn on fuel supply valve.• The fuel level is too low in the fuel tank. Fill the fuel tank.
The generator runs for a short time and shuts down.	<ul style="list-style-type: none">• There is a problem with the generator and the emergency shut down system has activated to shut down the generator. Find and correct the problem, then restart the generator.• The fuel level is too low in the fuel tank that supplies the generator. Fill the fuel tank.• The generator is overloaded. Manage AC accessory use to reduce excess amperage draw. <p>Note: The fuel withdrawal tube for the generator is shorter than the main engine tubes. Therefore, the generator will run out of fuel before the boat engines. This is to prevent the generator from consuming reserve fuel.</p>

Schematics

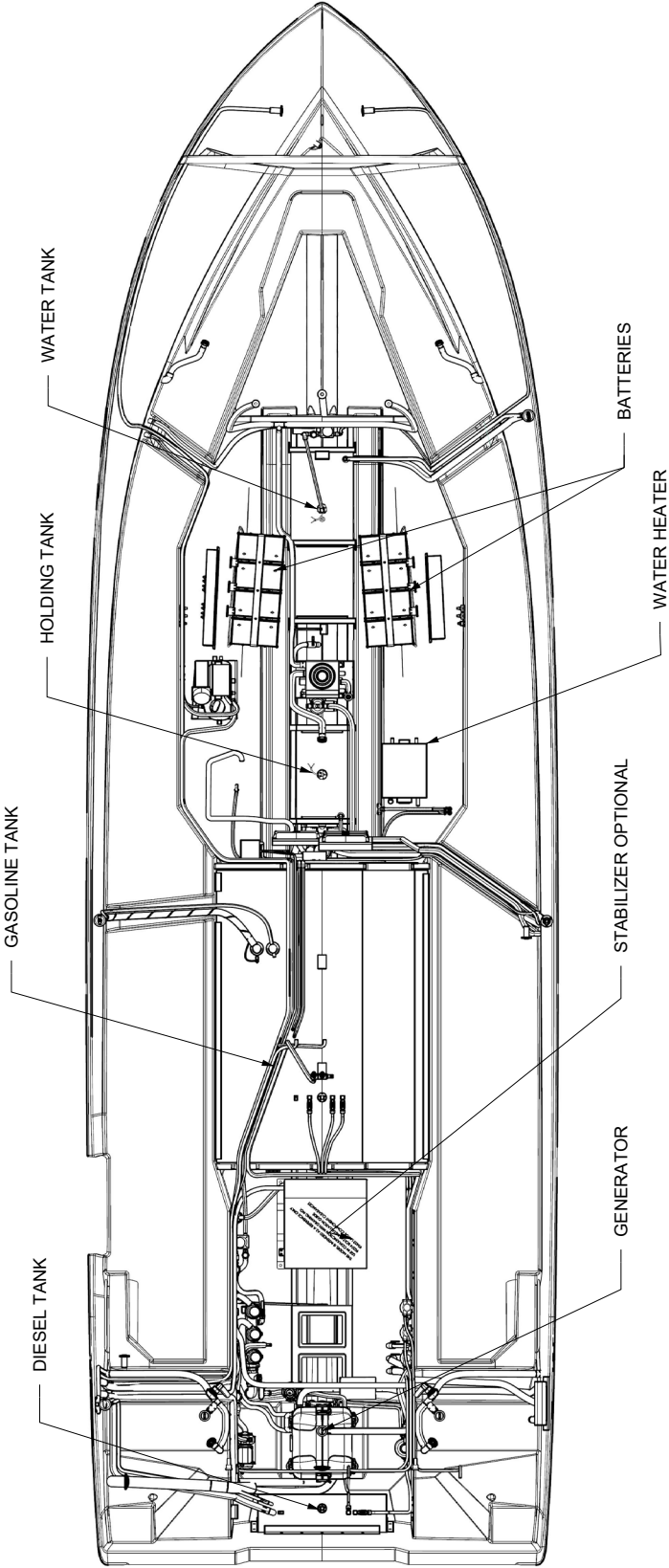

Bilge Layout

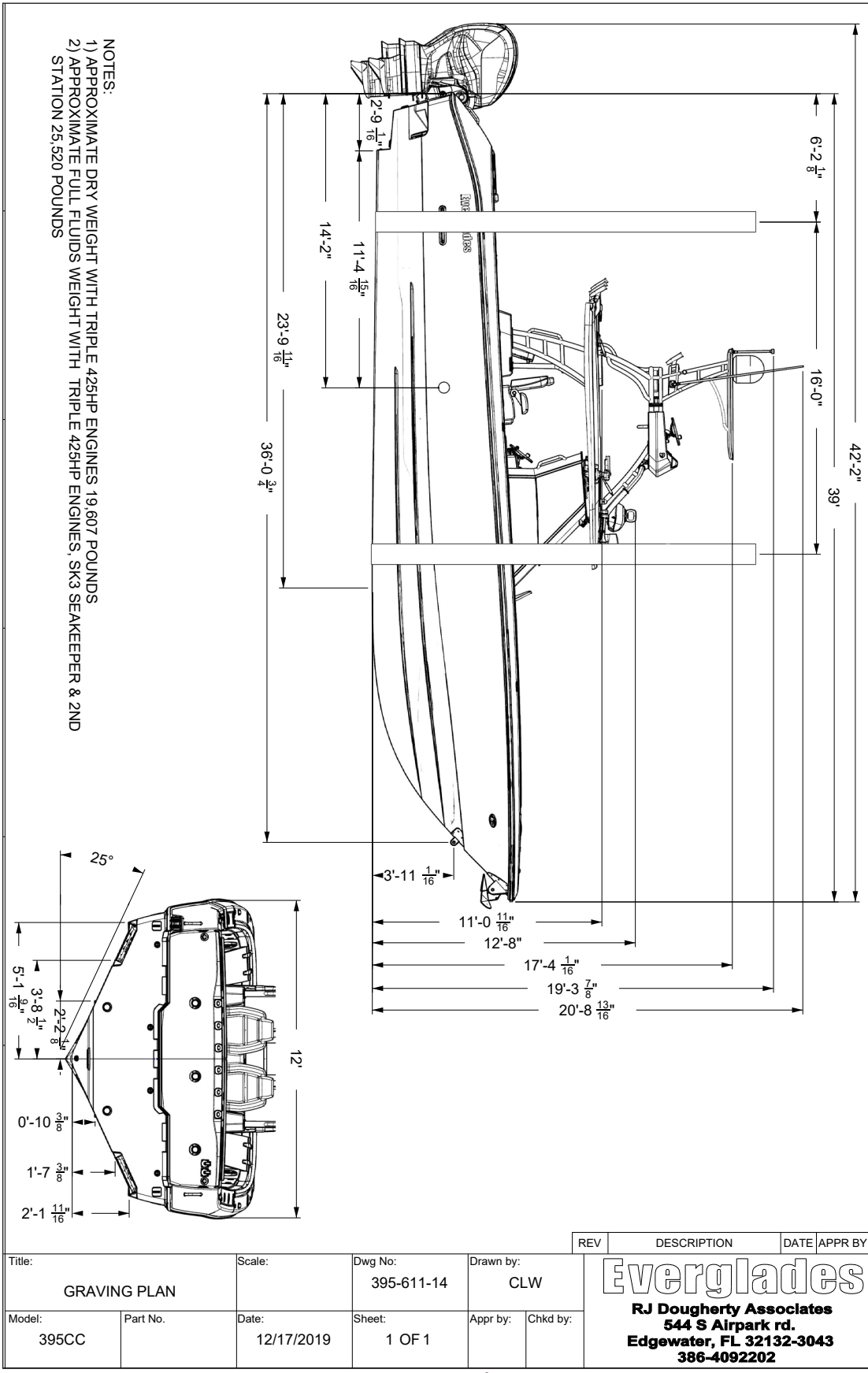

Graving Plan

Everglades

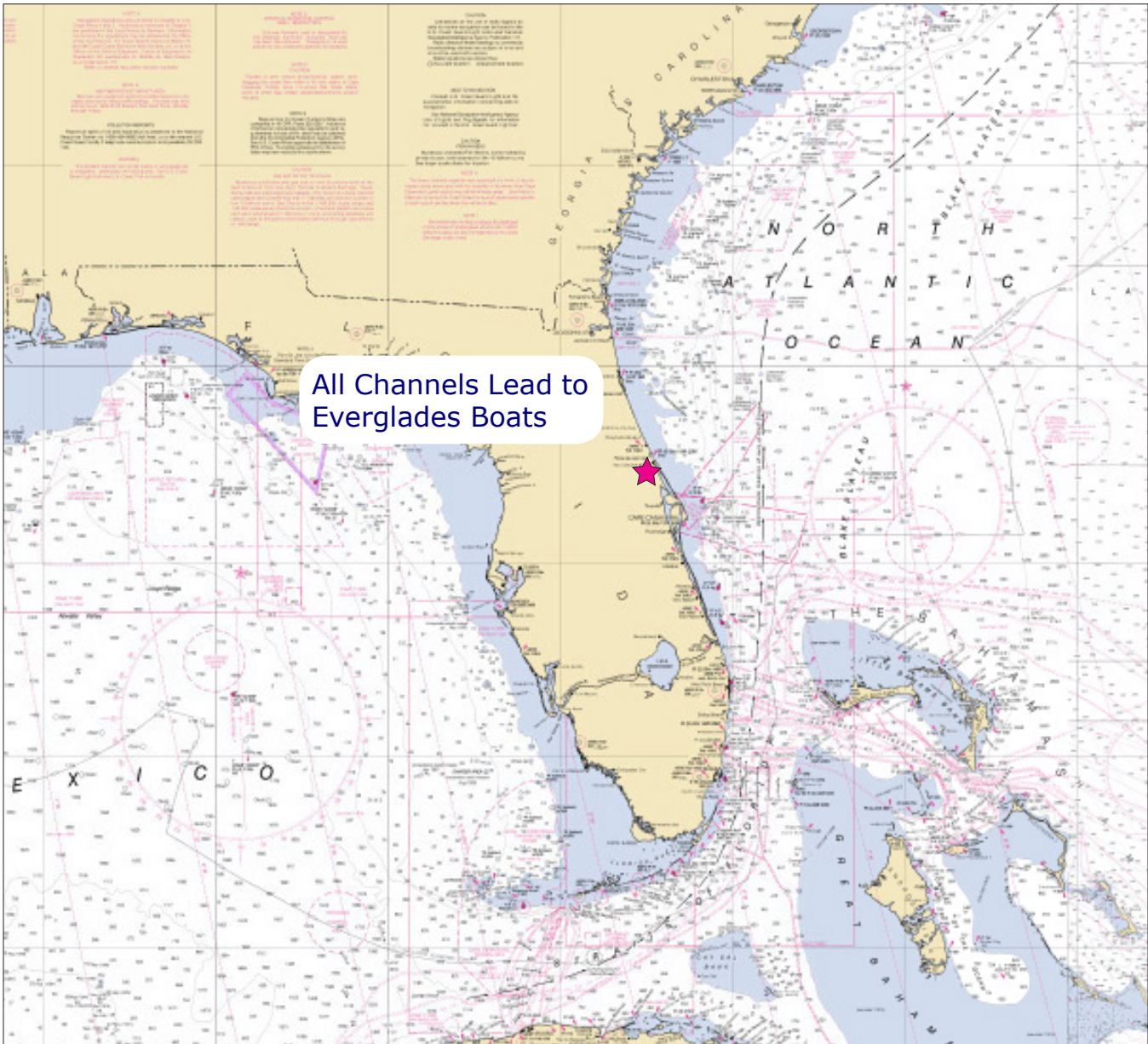

All Channels Lead to
Everglades Boats

Everglades Boats
544 Air Park Road
Edgewater, Florida 32132