

OWNER'S MANUAL

235 CC



Everglades

TABLE OF CONTENTS

TABLE OF CONTENTS	3
SAFETY INFORMATION	7
BOAT INFORMATION	8
SPECIFICATIONS	9
INTRODUCTION & IMPORTANT INFORMATION	11
OWNER / OPERATOR INFORMATION	13

Chapter 1: SAFETY EQUIPMENT

1.1 General	15
1.2 Engine Alarms	15
1.3 Neutral Safety Switch	15
1.4 Engine Stop Switch	15
1.5 Required Safety Equipment	16
1.6 Bilge and Fuel Fires	17
1.7 First Aid	18
1.8 Additional Safety Equipment	18
1.9 Caution & Warning Labels.....	20

Chapter 2: OPERATION

2.1 General	21
2.2 Rules of the Road	21
2.3 Pre-Cruise Check	24
2.4 Operating Your Boat	25
2.5 Docking, Anchoring and Mooring	26
2.6 Controls, Steering or Propulsion System Failure.....	28
2.7 Collision.....	29
2.8 Grounding, Towing & Rendering Assistance	29
2.9 Flooding or Capsizing.....	29
2.10 Fishing.....	30
2.11 Man Overboard	30
2.12 Water Skiing and Wakeboarding	30
2.13 Maximum Capacities Plate	32
2.14 Trailering Your Boat	32

Chapter 3: PROPULSION SYSTEM

3.1 General	35
3.2 Drive System Corrosion	35
3.3 Engine Lubrication.....	36
3.4 Engine Cooling System	36
3.5 Propellers	36
3.6 Performance Issues and Propellers	37
3.7 Engine Instrumentation	38

TABLE OF CONTENTS

Chapter 4:

HELM CONTROL SYSTEMS

4.1 General	41
4.2 Engine Throttle and Shift Controls	41
4.3 Neutral Safety Switch	42
4.4 Engine Power Tilt and Trim	43
4.5 Engine Stop Switch	44
4.6 Steering System	45
4.7 Joystick Control	46
4.8 Trim Tabs	47
4.9 Control Systems Maintenance	48

Chapter 5:

FUEL SYSTEM

5.1 General	51
5.2 Outboard Fuel System	52
5.3 Fueling Instructions	53
5.4 Fuel System Maintenance	54

Chapter 6:

ELECTRICAL SYSTEM

6.1 General	57
6.2 12 Volt System Overview	57
6.3 Batteries & Battery Switches	57
6.4 Ignition Switch Panels	59
6.5 12 volt Accessory Switch Panels	60
6.7 DC Circuit Breakers	64
6.8 Engine Control Systems Circuit Protection	65
6.9 Accessory Fuse Panels	66
6.10 120 Volt AC Battery Charging System	67
6.11 Bonding System	68
6.12 Electrical System Maintenance	69

Chapter 7:

Fresh Water System

7.1 General	71
7.2 Fresh Water System Operation	71
7.3 Fresh Water System Maintenance	72

Chapter 8:

RAW WATER SYSTEM

8.1 General	73
8.2 Raw Water System Operation	73
8.3 Baitwell	74
8.4 Raw Water System Maintenance	75

TABLE OF CONTENTS

Chapter 9:

DRAINAGE SYSTEMS

9.1 General	77
9.2 Cockpit Sole Drains	77
9.3 Hardtop Drains	77
9.4 Bilge Drainage	78
9.5 Fishboxes, Baitwell & Storage Compartment Drains	79
9.6 Drainage System Maintenance	80

Chapter 10:

VENTILATION SYSTEM

10.1 Cabin Ventilation	81
10.2 Windshield Ventilation	82
10.3 Bilge Ventilation	82
10.4 Maintenance	82

Chapter 11:

EXTERIOR EQUIPMENT

11.1 Deck Rails & Deck Hardware	83
11.2 Rope Locker & Optional Windlass	83
11.3 Hull	87
11.4 Cockpit Features	89
11.5 Center Console & Helm	97
11.6 Hardtop	99
11.7 Aftermarket Hardtop or Tower	100

Chapter 12:

INTERIOR EQUIPMENT

12.1 Head Compartment	101
12.2 Portable Marine Head	102

Chapter 13:

ROUTINE MAINTENANCE

13.1 Exterior Hull & Deck	103
13.2 Upholstery, Canvas & Enclosures	107
13.3 Interior	108
13.4 Bilge, Pumps & Components	109
13.5 Drainage System	109

Chapter 14:

SEASONAL MAINTENANCE

14.1 Storage & Lay-up	111
14.2 Winterizing	113
14.3 Recommissioning	115

TABLE OF CONTENTS

Appendix A:

SCHEMATICS	117
Drainage System	117
Battery Board Fuse Location	118
Graving Plan	119

Appendix B:

OCCUPANT SEATING LOCATIONS.....	121
---------------------------------	-----

Appendix C:

GLOSSARY OF TERMS	123
-------------------------	-----

Appendix D:

MAINTENANCE LOG	127
-----------------------	-----

Appendix E:

BOATING ACCIDENT REPORT	133
-------------------------------	-----

Appendix F:

FLOAT PLAN.....	137
-----------------	-----

Appendix G:

TROUBLESHOOTING GUIDE	139
-----------------------------	-----

SAFETY INFORMATION

Your Everglades owner's manual has been written to include a number of safety instructions to assure the safe operation and maintenance of your boat. These instructions are in the form of **DANGER**, **WARNING** and **CAUTION** statements. The following definitions apply:

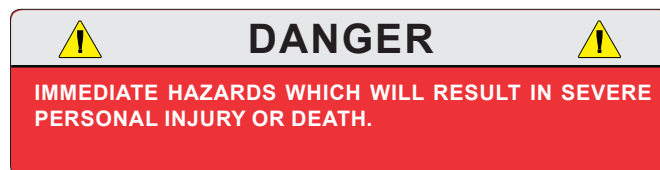
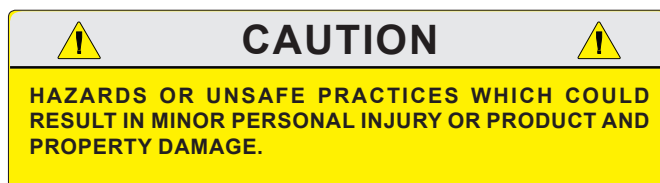

All instructions given in this book are as seen from the stern looking toward the bow, with starboard being to your right and port to your left. A glossary of boating terms is included.

IMPORTANT NOTE: Your boat uses an internal combustion engine and flammable fuel. Every precaution has been taken by Everglades to reduce the risks associated with possible injury and damage from fire or explosion, but your own precaution and good maintenance procedures are necessary in order to enjoy safe operation of your boat.

BOAT INFORMATION

Please fill out the following information section and leave it in your Everglades owner's manual. This information will be important for you, your dealer and/or Everglades service personnel to know, if you may need to call them for technical assistance or service.

BOAT	
MODEL:	HULL SERIAL #:
PURCHASE DATE:	DELIVERY DATE:
IGNITION KEY #:	REGISTRATION #:
DOOR KEYS #:	OTHER KEYS #:
ENGINE	
MAKE:	MODEL:
SERIAL #:	
PROPELLER	
MAKE:	BLADES:
DIAMETER/PITCH:	
TRAILER	
MAKE:	MODEL:
SERIAL #:	GVWR:
TIRE SIZE:	
OPTIONS	
ADDITIONAL EQUIPMENT	
DEALER	EVERGLADES
NAME:	REPRESENTATIVE:
DEALER/PHONE:	PHONE:
SALESMAN:	ADDRESS:
SERVICE MANAGER:	
ADDRESS:	
DEALER E- MAIL:	EVERGLADES E- MAIL:

All information, illustrations and specifications contained in this manual are based on the latest product information available at the time of publication. Everglades Boats reserves the right to make changes at anytime, without notice, in colors, materials, equipment, specifications and models.

SPECIFICATIONS

235 CC Specifications

HULL LENGTH OVERALL W/O ENGINE	24'
HULL LENGTH OVERALL W/ ENGINE	25'
BEAM	8' 6"
WEIGHT DRY - WITH ENGINE (APPROX)	5,600 lbs
DEADRISE @ TRANSOM	19°
DEADRISE AVERAGE	36°
DRAFT WITH ENGINE UP	19"
DRAFT WITH ENGINE DOWN	35"
TRANSOM HEIGHT	25"
BRIDGE CLEARANCE W/ HARDTOP	7' 10"
FUEL CAPACITY	105 gal
WATER TANK CAPACITY	9 gal
MAXIMUM HORSEPOWER	300 hp

Notice:

Dry weight is the average weight of the base boat without, fuel, water, waste or gear.

Draft and bridge clearance are to the full fluids waterline.

Weights are approximate and may differ from boat to boat.

NOTES

INTRODUCTION & IMPORTANT INFORMATION

All instructions given in this book are as seen from the stern looking toward the bow with starboard being to your right and port to your left. The information and precautions listed in this manual are not all inclusive. It may be general in nature in some cases and detailed in others and is designed to provide you with a basic understanding of your Everglades boat and some of the responsibilities that go along with owning/operating your boat.

The suppliers of some of the major components such as engines, pumps and appliances, provide their own owner's manuals which have been included with your boat. You should read the information in this manual and the manuals of other suppliers completely and have a thorough understanding of all component systems and their proper operation before operating your boat.

REMEMBER - IT IS YOUR RESPONSIBILITY TO ENSURE THAT YOUR BOAT IS SAFE FOR YOU AND YOUR PASSENGERS. ALWAYS EXERCISE GOOD COMMON SENSE WHEN INSTALLING EQUIPMENT AND OPERATING THE BOAT.

Warranty and Warranty Registration Cards

The Everglades Limited Warranty Statement is included with your boat. It has been written to be clearly stated and easily understood. If you have any questions after reading the warranty, please contact the Everglades Boats Customer Service Department.

Everglades, engine manufacturers and the suppliers of major components maintain their own manufacturer's warranty and service facilities. It is important that you properly complete the warranty registration cards included with your boat and engine and mail them back to the manufacturer to register your ownership. This should be done within 15 days of the date of purchase and before the boat is put into service. A form for recording this information for your records is provided at the beginning of this manual. This information will be important for you and service personnel to know, if and when you may need service or technical information.

The boat warranty registration requires the Hull Identification Number "HIN" which is located on the starboard side of the transom, just below the rubrail. The engine warranty registration requires the engine serial numbers. Please refer to the engine owner's manual for the location of the serial numbers.



Hull ID # On Starboard Side of Transom

IMPORTANT:

The terms and conditions of the Everglades Boats Limited Warranty are outlined in the warranty statement included in this manual. The manufacturer will automatically honor the warranty to the original purchaser for 15 days from the date of purchase. However, during that 15 day period, owners must comply with the steps outlined in the warranty statement to validate their warranty.

All boat manufacturers are required by the Federal Boat Safety Act of 1971 to notify first time owners in the event any defect is discovered "which creates a substantial risk of personal injury to the public." It is essential that we have your warranty registration card complete with your name and mailing address in our files so that we can comply with the law if it should become necessary.

Your Everglades Boats Dealer will assist you in filling in the hull number and other data required on your Registration Card. Check to see that your card is complete and signed. Detach and mail. Your Warranty Registration Card will be added to our permanent files.

Transferring the Limited Structural Warranty

For a transfer fee, Everglades Boats will offer to extend a Transferable Limited Structural Hull Warranty to subsequent owners of Everglades Boats. Please refer to the Everglades Limited Warranty Statement for the terms and conditions of the Transferable Limited Structural Hull Warranty and the procedure to transfer the warranty.

Product Changes

Everglades is committed to the continuous improvement of our boats. As a result, some of the equipment described in this manual or pictured in the catalog may change or no longer be available. All information, illustrations and specifications contained in this manual are based on the latest product information available at the time of publication. Everglades Boats reserves the right to make changes at anytime, without notice, in colors, materials, equipment, specifications and models. If you have questions about the equipment on your Everglades, please contact the Everglades Boats Customer Service Department.

Service

All warranty repairs must be performed by an authorized Everglades Dealer. Should a problem develop that is related to faulty workmanship or materials, as stated in the Limited Warranty, you should contact your Everglades dealer to arrange for the necessary repair. If you are not near your dealer or another authorized Everglades dealer or the dealer fails to remedy the cause of the problem, then contact Everglades within 15 days.

Everglades will not reimburse boat owners for warranty repairs performed without prior authorization provided in writing.

It is the boat owner's responsibility to deliver the boat to the dealer for warranty service.

Registration and Numbering

Federal law requires that all undocumented vessels equipped with propulsion machinery be registered in the state of principal use. A certificate of number will be issued upon registering the boat. These numbers must be displayed on your boat. The owner/operator of a boat must carry a valid certificate of number whenever the boat is in use. When moved to a new state of principal use, the certificate is valid for 60 days.

In order to be valid, the numbers must be installed to the proper specifications. Check with your dealer or state boating authority for numbering requirements. The Coast Guard issues the certificate of number in Alaska; all others are issued by the state.

Insurance

In most states the boat owner is legally responsible for damages or injuries he or someone else operating the boat causes. Responsible boaters carry adequate liability and property damage insurance for their boat. You should also protect the boat against physical damage and theft. Some states have laws requiring minimum insurance coverage. Contact your dealer or state boating authority for information on the insurance requirements in your boating area.

Reporting Boating accidents

All boating accidents must be reported by the operator or owner of the boat to the proper marine law enforcement authority for the state in which the accident occurred. Immediate notification is required if a person dies or disappears as a result of a recreational boating accident.

If a person dies or there are injuries requiring more than first aid, a formal report must be filed within 48 hours.

A formal report must be made within 10 days for accidents involving more than \$500.00 damage or the complete loss of a boat.

A Boating Accident Report form is located near the back of this manual to assist you in reporting

an accident. If you need additional information regarding accident reporting, please call the Boating Safety Hotline, 800-368-5647.

Education

If you are not an experienced boater, we recommend that the boat operator and other people that normally accompany the operator, enroll in a boating safety course. Organizations such as the U.S. Power Squadrons, United States Coast Guard Auxiliary, State Boating Authorities and the American Red Cross offer excellent boating educational programs. These courses are worthwhile even for experienced boaters to sharpen your skills or bring you up to date on current rules and regulations. They can also help in providing local navigational information when moving to a new boating area. Contact your dealer, State Boating Authority or the Boating Safety Hotline, 800-368-5647 for further information on boating safety courses.

Required Equipment

U.S. Coast Guard regulations require certain equipment on each boat. The Coast Guard also sets minimum safety standards for vessels and associated equipment. To meet these standards some of the equipment must be Coast Guard approved. "Coast Guard Approved Equipment" has been determined to be in compliance with USCG specifications and regulations relating to performance, construction or materials. The equipment requirements vary according to the length, type of boat and the propulsion system. Some of the Coast Guard equipment is described in the Safety Equipment chapter of this manual. For a more detailed description, obtain "Federal Requirements And Safety Tips For Recreational Boats" by contacting the Boating Safety Hotline 800-368-5647 or your local marine dealer or retailer.

Some state and local agencies impose similar equipment requirements on waters that do not fall under Coast Guard jurisdiction. These agencies may also require additional equipment that is not required by the Coast Guard. Your dealer or local boating authority can provide you with additional information for the equipment requirements for your boating area.

NOTES

SAFETY EQUIPMENT

1.1 General

Your boat and outboard engine have been equipped with safety equipment designed to enhance the safe operation of the boat and to meet U.S. Coast Guard safety standards. The Coast Guard or state, county and municipal law enforcement agencies require certain additional accessory safety equipment on each boat. This equipment varies according to length and type of boat and type of propulsion. The accessory equipment typically required by the Coast Guard is described in this chapter. Some local laws require additional equipment. It is important to obtain "Federal Requirements And Safety Tips for Recreational Boats," published by the Coast Guard and copies of state and local laws, to make sure you have the required equipment for your boating area.

Your boat is equipped with engine alarms. The alarm systems are designed to increase your boating safety by alerting you to potentially serious problems in the primary power system. Alarm systems are not intended to lessen or replace good maintenance and pre-cruise procedures.

This chapter also describes safety related equipment that could be installed on your boat. This equipment will vary depending on the type of engine and other options installed by you or your dealer.

1.2 Engine Alarms

Most outboard engines are equipped with an audible alarm system mounted in the helm area that monitors selected critical engine systems. The alarm will sound if one of these systems begins to fail. Refer to the engine owner's manual for information on the alarms installed with your engine.

If the alarm sounds:

- Immediately throttle the engine back to idle.
- Shift the transmission to neutral.
- Monitor the engine gauges to determine the cause of the problem.
- If necessary, shut off the engine and investigate until the cause of the problem is found.



Throwable Device & Personal PFD

1.3 Neutral Safety Switch

Every control system has a neutral safety switch incorporated into it. This device prohibits the engine from being started while the shift lever is in any position other than the neutral position. If the engine will not start, slight movement of the shift lever may be necessary to locate the neutral position and disengage the safety cutout switch. Control adjustments may be required to correct this condition should it persist. See your Everglades dealer for necessary control adjustments. Please refer to the Helm Control Systems chapter for more information on the neutral safety switch.

1.4 Engine Stop Switch

Your boat is equipped with an engine stop switch and lanyard. When the lanyard is pulled it will engage the switch and shut off the engine. We strongly recommend that the lanyard be attached to the driver and the stop switch whenever the engine is running. If the engine will not start, it could be because the lanyard is not properly inserted into the engine stop switch. Always make sure the lanyard is properly attached to the engine stop switch before attempting to start the engine.

Notice:

In some states, a lanyard attached to the driver at all times is required by law.

Notice:

You should carry an extra stop switch lanyard and instruct at least one other crew member on the operation of the stop switch and location of the extra lanyard.

1.5 Required Safety Equipment

Besides the equipment installed on your boat by Everglades, certain other equipment is required by the U.S. Coast Guard to help ensure passenger safety. Items like a sea anchor, working anchor, extra dock lines, flare pistol, life vests, a line permanently secured to your ring buoy, etc., could at some time save your passengers' lives or save your boat from damage. Refer to the "Federal Requirements And Safety Tips For Recreational Boats" pamphlet for a more detailed description of required equipment. You also can contact the U.S. Coast Guard Boating Safety Hotline, 800-368-5647, for information on boat safety courses and brochures listing the Federal equipment requirements. Also, check your local and state regulations.

The Coast Guard Auxiliary offers a "Courtesy Examination." This inspection will help ensure that your boat is equipped with all of the necessary safety equipment. The following is a list of the accessory equipment required on your boat by the U.S. Coast Guard:

Personal Flotation Devices (PFDs)

PFDs must be Coast Guard approved, in good and serviceable condition and of appropriate size for the intended user. Wearable PFDs must be readily accessible, meaning you must be able to put them on in a reasonable amount of time in an emergency. Though not required, the Coast Guard emphasizes that PFDs should be worn at all times when the vessel is underway. Throwable devices must be immediately available for use. All Everglades boats must be equipped with at least one Type I, II or III PFD for each person on board, plus one throwable device (Type IV).

Notice:

Many state laws now require that children 13 years old and under must wear a PFD at all times.

Anyone being towed on skis, wakeboards and other water sports equipment is considered a passenger on the boat and must wear a Coast Guard approved life jacket at all times.



Visual Distress Signals

All boats used on coastal waters, the Great Lakes, territorial seas and those waters connected directly to them, must be equipped with Coast Guard approved visual distress signals. These signals are either Pyrotechnic or Non-Pyrotechnic devices.

Pyrotechnic Visual Distress Signals:

Pyrotechnic visual distress signals must be Coast Guard approved, in serviceable condition and readily accessible. They are marked with a date showing the service life, which must not have expired. A minimum of three are required. Some pyrotechnic signals meet both day and night use requirements. They should be stored in a cool, dry location. They include:

- Pyrotechnic red flares, hand held or aerial.
- Pyrotechnic orange smoke, hand-held or floating.
- Launchers for aerial red meteors or parachute flares.

	WARNING	
<p>PYROTECHNICS ARE UNIVERSALLY RECOGNIZED AS EXCELLENT DISTRESS SIGNALS. HOWEVER, THERE IS POTENTIAL FOR INJURY AND PROPERTY DAMAGE IF NOT PROPERLY HANDLED. THESE DEVICES PRODUCE A VERY HOT FLAME AND THE RESIDUE CAN CAUSE BURNS AND IGNITE FLAMMABLE MATERIAL. PISTOL LAUNCHED AND HAND-HELD PARACHUTE FLARES AND METEORS HAVE MANY CHARACTERISTICS OF A FIREARM AND MUST BE HANDLED WITH CAUTION. IN SOME STATES THEY ARE CONSIDERED A FIREARM AND PROHIBITED FROM USE. ALWAYS BE EXTREMELY CAREFUL AND FOLLOW THE MANUFACTURER'S INSTRUCTIONS EXACTLY WHEN USING PYROTECHNIC DISTRESS SIGNALS.</p>		

Non-Pyrotechnic Devices

Non-Pyrotechnic visual distress signals must be in serviceable condition, readily accessible and certified by the manufacturer as complying with U.S. Coast Guard requirements. They include:

- Orange Distress Flag (Day use only)

The distress flag is a day signal only. It must be at least 3 x 3 feet with a black square and ball on an orange background. It is most distinctive when attached and waved from a paddle or boat hook.

Safety Equipment

- Electric Distress Light (Night use only)

The electric distress light is accepted for night use only and must automatically flash the international SOS distress signal. Under "Inland Navigation Rules," a high intensity white light flashing at regular intervals from 50-70 times per minute is considered a distress signal.

Sound Signaling Devices

The navigation rules require sound signals to be made under certain circumstances. Recreational vessels also are required to sound fog signals during periods of reduced visibility. Therefore, you must have some means of making an efficient sound signal.

Navigation Lights

Recreational boats are required to display navigation lights between sunset and sunrise and other periods of reduced visibility (fog, rain, haze, etc.) Navigation lights are intended to keep other vessels informed of your presence and course. Your boat is equipped with navigation lights required by the U.S. Coast Guard at the time of manufacture. It is up to you to make sure they are operational and turned on when required.

Fire Extinguishers

At least one fire extinguisher is required on all Everglades boats. Coast Guard approved fire extinguishers are hand-portable, either B-I or B-II classification and have a specific marine type mounting bracket. It is recommended that the extinguishers be mounted in a readily accessible position.





Fire extinguishers require regular inspections to ensure that:

- Seals & tamper indicators are not broken or missing.
- Pressure gauges or indicators read in the operable range.
- There is no obvious physical damage, corrosion, leakage or clogged nozzles.

Refer to the "Federal Requirements And Safety Tips For Recreational Boats" pamphlet or contact the U.S. Coast Guard Boating Safety Hotline, 800-368-5647, for information on the type and size fire extinguisher required for your boat.



Please refer to the information provided by the fire extinguisher manufacturer for instructions on the proper maintenance and use of your fire extinguisher.

	CAUTION	
INFORMATION FOR AGENT FE-241 AND FE-227 FIRE EXTINGUISHERS IS PROVIDED BY THE MANUFACTURER. IT IS ESSENTIAL THAT YOU READ THE INFORMATION CAREFULLY AND COMPLETELY UNDERSTAND THE SYSTEM, IN THEORY AND OPERATION, BEFORE USING YOUR BOAT.		

1.6 Bilge and Fuel Fires

Fuel compartment and bilge fires are very dangerous because of the presence of gasoline in the various components of the fuel system and the possibility for explosion. You must make the decision to fight the fire or abandon the boat. If the fire cannot be extinguished quickly or it is too intense to fight, abandoning the boat may be your only option.

If you find yourself in this situation, make sure all passengers have a life preserver on, go over the side and swim well upwind of the boat. This will keep you and your passengers well clear of any burning fuel that could be released and spread on the water as the boat burns or in the event of an explosion. When clear of the danger, check about and account for all those who were aboard with you. Give whatever assistance you can to anyone in need or in the water without a buoyant device. Keep everyone together in a group for morale and to aid rescue operations.

	WARNING	
ALL TYPES OF FUEL CAN EXPLODE. IN THE EVENT OF A FUEL COMPARTMENT OR BILGE FIRE, YOU MUST MAKE THE DIFFICULT DECISION TO FIGHT THE FIRE OR ABANDON THE BOAT. YOU MUST CONSIDER YOUR SAFETY, THE SAFETY OF YOUR PASSENGERS, THE INTENSITY OF THE FIRE AND THE POSSIBILITY OF AN EXPLOSION IN YOUR DECISION.		



Typical First Aid Kit

1.7 First Aid

It is the operator's responsibility to be familiar with the proper first-aid procedures and be able to care for minor injuries or illnesses of your passengers. In an emergency, you could be far from professional medical assistance. We strongly recommend that you be prepared by receiving training in basic first aid and CPR. This can be done through classes given by the Red Cross or your local hospital.

Your boat should also be equipped with at least a simple marine first-aid kit and a first-aid manual. The marine first-aid kit should be designed for the marine environment and be well supplied. It should be accessible and each person on board should be aware of its location. As supplies are used, replace them promptly. Some common drugs and antiseptics may lose their strength or become unstable as they age. Ask a medical professional about the supplies you should carry and the safe shelf life of prescription drugs or other medical supplies that may be in your first-aid kit. Replace questionably old supplies whether they have been used or not.

In many emergency situations, the Coast Guard can provide assistance in obtaining medical advice

for treatment of serious injuries or illness. If you are within VHF range of a Coast Guard Station, make the initial contact on channel 16 and follow their instructions.

1.8 Additional Safety Equipment

Besides meeting the legal requirements, prudent boaters carry additional safety equipment. This is particularly important if you operate your boat offshore. You should consider the following items, depending on how you use your boat.

Satellite EPIRBs

EPIRBs (Emergency Position Indicating Radio Beacon) operate as part of a worldwide distress system. When activated, EPIRBs will send distress code homing beacons that allow Coast Guard aircraft to identify and find them quickly. The satellites that receive and relay EPIRB signals are operated by the National Oceanic and Atmospheric Administration (NOAA) in the United States. The EPIRB should be mounted and registered according to the instructions provided with the beacon, so that the beacon's unique distress code can be used to quickly identify the boat and owner.

Safety Equipment

Marine Radio

A marine radio is the most effective method of receiving information and requesting assistance. VHF marine radios are used near shore and single sideband radios are used for long range communication.

There are specific frequencies to use in an emergency. The VHF emergency channel is 16 in the United States. You should read the owners manual for your radio and know how to use it in an emergency or for normal operation. If you hear a distress call you should assist or monitor the situation until help is provided.

Additional Equipment to Consider:

Cell Phone	Spare Anchor
Fenders	Heaving Line
Mirror	First Aid Kit
Tool Kit	Flashlight & Batteries
Anchor	Search light
Boat Hook	Sunburn Lotion
Mooring Lines	Ring Buoy or Boat Cushion
Binoculars	Whistle or Horn
Extra Clothing	Portable Radio
Chart and Compass	Marine Hardware
Food & Water	Spare Keys
Sunglasses	Spare Parts
Spare Propeller	Spare Propeller Hub Kit

Safety Equipment

1.9 Caution & Warning Labels

The caution and warning labels shown are examples of the labels that could be on your boat. The actual labels and their location could vary on your boat.

Caution and warning labels must remain legible for the safety of you and your passengers. If a label becomes missing or damaged it must be replaced. Immediately contact your dealer or Everglades Customer Service for a replacement.

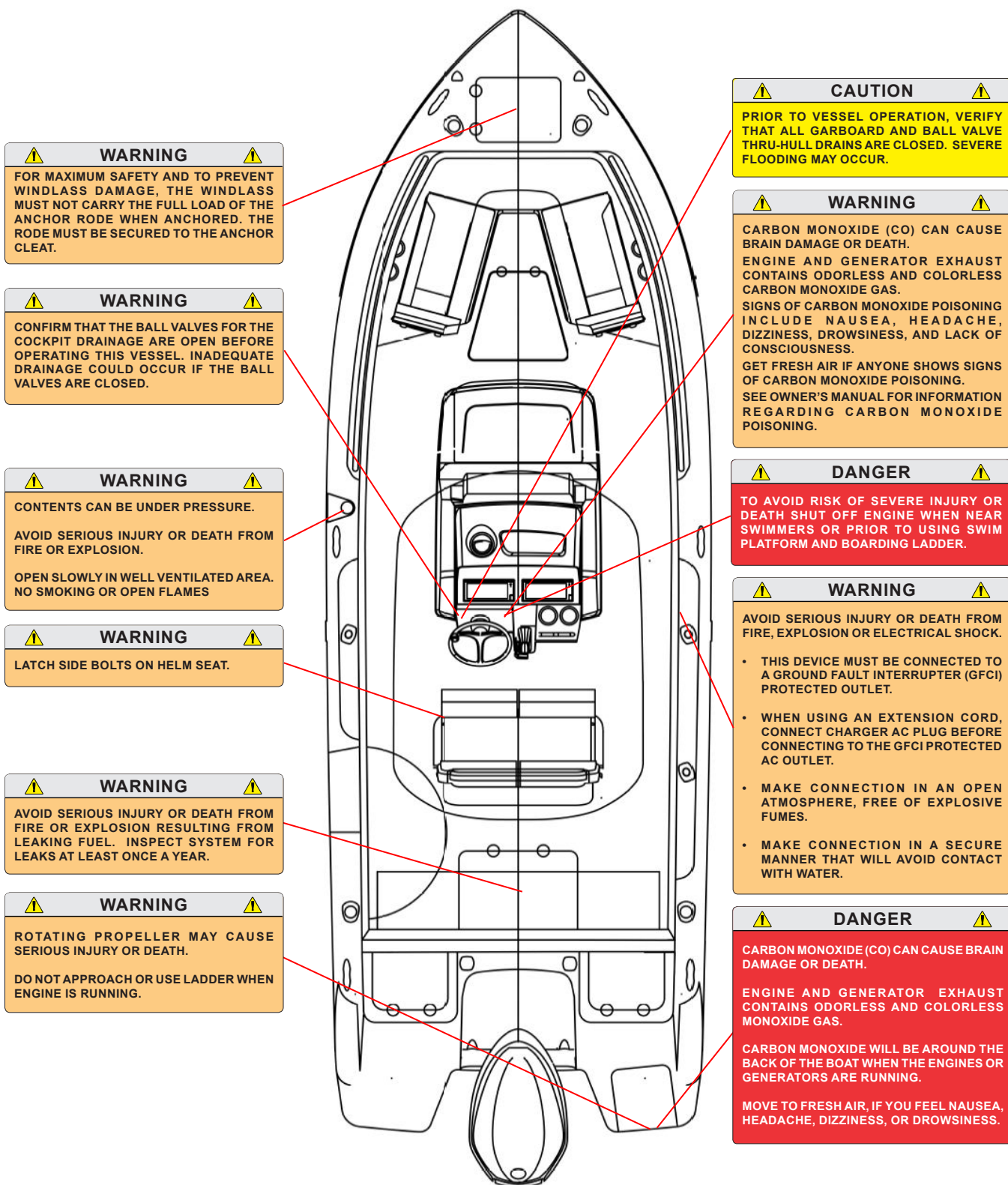

OPERATION

2.1 General

Before you start the engines on your boat, you should become familiar with the various component systems and their operation, and have performed a "Pre-Cruise System Check." A thorough understanding of the component systems and their operation is essential to the proper operation of the boat. This manual and the associated manufacturers' information is provided to enhance your knowledge of your boat. Please read them carefully.

Your boat must have the necessary safety equipment on board and be in compliance with the U.S. Coast Guard, local and state safety regulations. There should be one Personal Floatation Device (PFD) for each person. Non-swimmers and small children should wear PFDs at all times. You should know and understand the "Rules of the Road" and have had an experienced operator brief you on the general operation of your new boat. At least one other person should be instructed on the proper operation of the boat in case the operator is suddenly incapacitated.

The operator is responsible for his safety and the safety of all passengers. When boarding or loading the boat, always step onto the boat, never jump. All passengers should be properly seated whenever the boat is operated above idle speed. Your passengers should not be allowed to sit on the seat backs, gunnels, bows, transoms or on fishing seats whenever the boat is underway. The passengers should also be seated to properly balance the load and must not obstruct the operator's view, particularly to the front.

Overloading and improper distribution of weight can cause the boat to become unstable and are significant causes of accidents. Know the weight capacity and horsepower rating of your boat. Do not overload or overpower your boat.

You should be aware of your limitations and the limitations of your boat in different situations or sea conditions. No boat is indestructible, no matter how well it is constructed. Any boat can be severely damaged if it is operated in a manner that exceeds its design limitations. If the ride is hard on you and your passengers, it is hard on

the boat as well. Always modify the boat speed in accordance with the sea conditions, boat traffic and weather conditions.

Remember, it is the operator's responsibility to use good common sense and sound judgement in loading and operating the boat.

2.2 Rules of the Road

As in driving an automobile, there are a few rules you must know for safe boating operation. The following information describes the basic navigation rules and action to be taken by vessels in a crossing, meeting or overtaking situations while operating in inland waters. These are basic examples and not intended to teach all the rules of navigation. For further information consult the "Navigation Rules" or contact the Coast Guard, Coast Guard Auxiliary, Department of Natural Resources, or your local boat club. These organizations sponsor courses in boat handling, including rules of the road. We strongly recommend such courses. Books on this subject are also available from your local library.

Notice:

Sailboats not under power, paddle boats, vessels unable to maneuver, vessels engaged in commercial fishing and other vessels without power have the right of way over motor powered boats. You must stay clear or pass to the stern of these vessels. Sailboats under power are considered motor boats.

Crossing Situations

When two motor boats are crossing, the boat on the right has the right-of-way. The boat with the right-of-way should maintain its course and speed. The other vessels should slow down and permit it to pass. The boats should sound the appropriate signals.

Meeting Head-On or Nearly-So Situations

When two motor boats are approaching each other head-on or nearly head-on, neither boat has the right-of-way. Both boats should reduce their speed and turn to the right so as to pass port side to port side, providing enough clearance for safe passage. The boats should sound the appropriate signals.

Overtaking Situations

When one motor boat is overtaking another motor boat, the boat that is being passed has the right-of-way. The overtaking boat must make the adjustments necessary to provide clearance for a safe passage of the other vessel. The boats should sound the appropriate signals.

The General Prudential Rule

In obeying the Rules of the Road, due regard must be given to all dangers of navigation and collision, and to any special circumstances, including the limitations of the vessels, which may justify a departure from the rules that is necessary to avoid immediate danger or a collision.

Night Operation

Recreational boats are required to display navigation lights between sunset and sunrise and other periods of reduced visibility such as fog, rain, haze, etc. When operating your boat at night you should:

- Make sure your navigation lights are on and working properly. Navigation lights warn others of your position and course and the position and course of other vessels.
- All navigation rules apply. If the bow light of another vessel shows red, you should give way to that vessel, if it shows green, you have the right-of-way. If you only see a white light you are either overtaking or the boat is anchored and you must give way in both cases.
- Slow down and never operate at high speeds when operating at night, stay clear of all boats and use good common sense. Always be ready to slow down or steer clear of other vessels, even if you have the right-of-way.
- Avoid bright lights that can destroy night vision, making it difficult to see navigation lights and the lights of other boats. You and your passengers should keep a sharp lookout for hazards, other boats and navigational aids.

Navigation Aids

Aids to navigation are placed along coasts and navigable waters as guides to mark safe water and to assist mariners in determining their position in relation to land and hidden dangers. Each aid to navigation is used to provide specific information. You should be familiar with these and any other markers used in your boating area.

Notice:

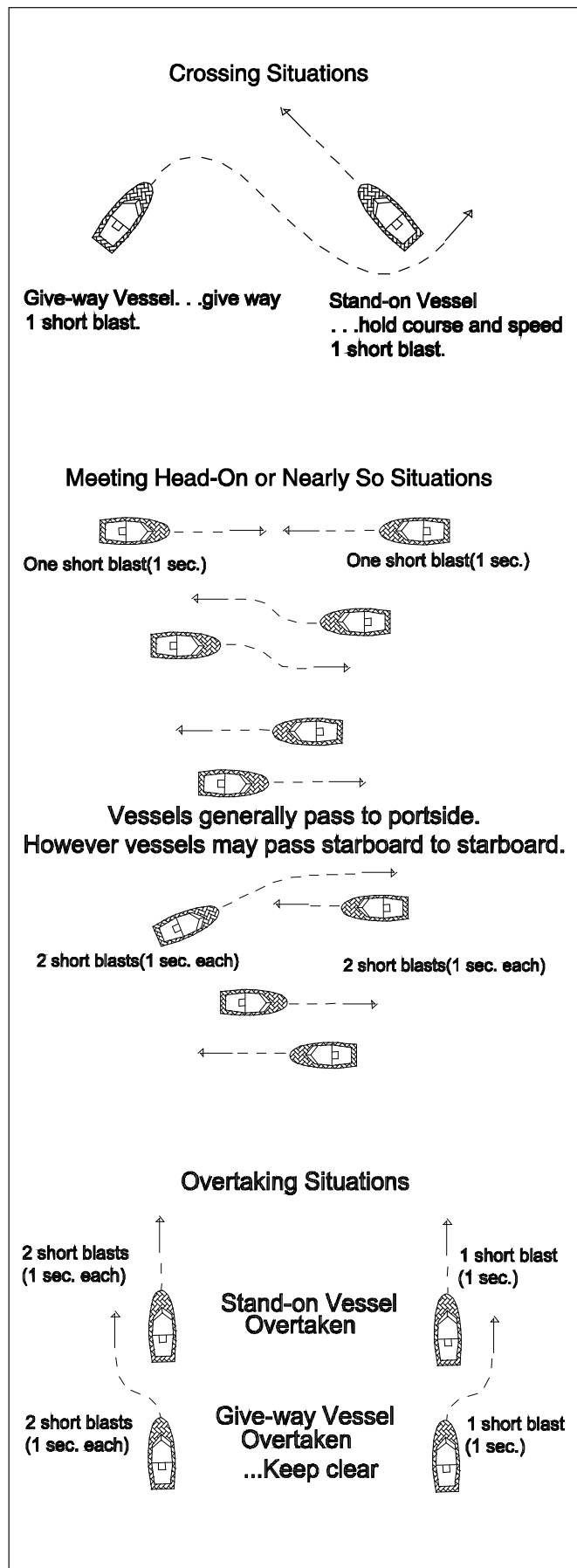

Storms and wave action can cause buoys to move. You should not rely on buoys alone to determine your position.













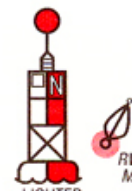
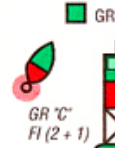

Navigational Aids Chart

REMEMBER THESE RULES

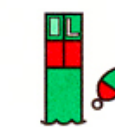
1. OVERTAKING - PASSING: Boat being passed has the right-of-way. KEEP CLEAR.
2. MEETING HEAD ON: Keep to the right.
3. CROSSING: Boat on right has the right-of-way. Slow down and permit boat to pass.

<p>← PORT</p> <p>Yield right-of-way to boats in your DANGER ZONE!</p>  <p>STARBOARD →</p> <p>DANGER ZONE (Dead ahead to 2 points abaft your starboard beam)</p>	<p>STORM WARNINGS</p>  <p>RED FLAG Small craft (winds to 33 knots)</p> <p>2 RED FLAGS Gale (winds up to 47 knots)</p> <p>SQUARE RED FLAG BLACK BOX (Storm)</p> <p>2 SQUARE RED FLAGS BLACK BOX (Hurricane)</p>																														
<p>WHISTLE SIGNALS</p> <p>ONE LONG BLAST: Warning signal (Coming out of slip)</p> <p>ONE SHORT BLAST: Pass on my port side</p> <p>TWO SHORT BLASTS: Pass on my starboard side</p> <p>THREE SHORT BLASTS: Engine(s) in reverse</p> <p>FOUR OR MORE BLASTS: Danger signal</p>	<p>BRIDGE SIGNALS</p> <table border="0"> <tr> <td>SOUND</td> <td></td> <td>VISUAL</td> <td>DAY (Flag)</td> <td>NIGHT (Lights)</td> </tr> <tr> <td>VESSEL: Open</td> <td>— ●</td> <td>VESSEL: Open</td> <td>□</td> <td>○</td> </tr> <tr> <td>BRIDGE: OK</td> <td>— ●</td> <td>BRIDGE: OK</td> <td>□</td> <td>○</td> </tr> <tr> <td>No</td> <td>● ● ● ● ● ●</td> <td>BRIDGE: OK</td> <td>Same</td> <td>Same</td> </tr> <tr> <td>VESSEL: Replies:</td> <td>● ● ● ● ● ●</td> <td>No</td> <td>◀ ◻ ▶</td> <td>◀ ● ▶</td> </tr> <tr> <td>RADIO: VHF CH. 13</td> <td></td> <td></td> <td></td> <td></td> </tr> </table>	SOUND		VISUAL	DAY (Flag)	NIGHT (Lights)	VESSEL: Open	— ●	VESSEL: Open	□	○	BRIDGE: OK	— ●	BRIDGE: OK	□	○	No	● ● ● ● ● ●	BRIDGE: OK	Same	Same	VESSEL: Replies:	● ● ● ● ● ●	No	◀ ◻ ▶	◀ ● ▶	RADIO: VHF CH. 13				
SOUND		VISUAL	DAY (Flag)	NIGHT (Lights)																											
VESSEL: Open	— ●	VESSEL: Open	□	○																											
BRIDGE: OK	— ●	BRIDGE: OK	□	○																											
No	● ● ● ● ● ●	BRIDGE: OK	Same	Same																											
VESSEL: Replies:	● ● ● ● ● ●	No	◀ ◻ ▶	◀ ● ▶																											
RADIO: VHF CH. 13																															

LATERAL AIDS AS SEEN ENTERING FROM SEAWARD

<p>PORT SIDE ODD NUMBERED AIDS</p> <p>GREEN LIGHT ONLY</p> <p>FLASHING: [diagram]</p> <p>OCCULTING: [diagram]</p> <p>QUICK FLASHING: [diagram]</p> <p>ISOPHASE: [diagram]</p> <p>LIGHTED BUOY:  G "9" FI G 4sec</p> <p>CAN:  G C "7"</p> <p>DAYMARK:  G "1"</p>	<p>SAFE WATER MID-CHANNELS OR FAIRWAYS NO NUMBERS — MAY BE LETTERED</p> <p>WHITE LIGHT ONLY MORSE CODE</p> <p>Mo (A) [diagram] [diagram] [diagram]</p> <p>SPHERICAL:  RW SP "G"</p> <p>MR:  RW "A"</p> <p>LIGHTED AND OR SOUND:  RW "N" Mo (A)</p> <p>PREFERRED CHANNEL NO NUMBERS — MAY BE LETTERED</p> <p>COMPOSITE GROUP FLASHING (2 + 1)</p> <p>[diagram] [diagram] [diagram] [diagram] [diagram]</p> <p>GREEN LIGHT ONLY</p> <p>RED LIGHT ONLY</p> <p>PREFERRED CHANNEL TO STARBOARD TOPMOST BAND GREEN:  GR "C" FI (2 + 1)</p> <p>PREFERRED CHANNEL TO PORT TOPMOST BAND RED:  RG "B" FI (2 + 1)</p> <p>CAN:  GR C "L"</p> <p>NUN:  RG N "W"</p> <p>DAYMARK:  GR "A"</p> <p>JR:  RG "B"</p>	<p>STARBOARD SIDE EVEN NUMBERED AIDS</p> <p>RED LIGHT ONLY</p> <p>FLASHING: [diagram]</p> <p>OCCULTING: [diagram]</p> <p>QUICK FLASHING: [diagram]</p> <p>ISOPHASE: [diagram]</p> <p>LIGHTED BUOY:  R "8" FI R 4sec</p> <p>NUN:  R N "6"</p> <p>DAYMARK:  R "2"</p>
---	---	---

2.3 Pre-Cruise Check

Before Starting the Engine:

- Check the weather forecast and sea conditions before leaving the dock. Decide if the planned cruise can be made safely.
- Be sure all required documents are on board.
- Be sure all necessary safety equipment is on board and operative. This should include items like the running lights, spotlight, life saving devices, etc. Please refer to the Safety Equipment chapter for additional information on safety equipment.
- Make sure you have signal kits and flare guns aboard and that they are current and in good operating condition.
- Be sure you have sufficient water and other provisions for the planned cruise.
- Leave a written message listing details of your planned cruise with a close friend ashore (Float Plan). The float plan should include a description of your boat, where you intend to cruise and a schedule of when you expect to arrive in the cruising area and when you expect to return. Keep the person informed of any changes in your plan to prevent false alarms. This information will tell authorities where to look and the type of boat to look for in the event you fail to arrive.
- Check the amount of fuel on board. Observe the "Rule of Thirds": one third of the fuel for the trip out, one third to return and one third in reserve. An additional 15% may be consumed in rough seas.
- Check the water separating fuel filters for leaks or corrosion.
- Check the crankcase oil level in the engine.
- Turn the battery switch on.
- Check the bilge water level. Look for other signs of potential problems. Monitor for the scent of fuel fumes.
- Test the automatic and manual bilge pump switches to make sure the systems are working properly. This is particularly important before running offshore.

- Have a tool kit aboard. The kit should include the following basic tools:

Hammer	Electrician's tape
Screwdrivers	Offset screwdrivers
Lubricating oil	Pliers
Jackknife	Adjustable wrench
Basic 3/8" ratchet set	Vise grip pliers
Hex key set	Needle nose pliers
Wire crimping tool	Wire connector Set
End wrench set	Medium slip-joint pliers
Diagonal cutting pliers	DC electrical test light



WARNING



THERE MUST BE AT LEAST ONE PERSONAL FLOTATION DEVICE ON BOARD FOR EVERY PERSON ON BOARD AND ONE THROW-OUT FLOTATION DEVICE. CHECK THE U.S. COAST GUARD STANDARDS FOR THE CORRECT TYPE OF DEVICE FOR YOUR BOAT.

- Have the following spare parts on board:

Extra light bulbs	Spark plugs
Fuses and circuit breakers	Main 12 volt fuses
Assorted stainless screws	Assorted stainless bolts
Flashlight and batteries	Drain plugs
Engine oil	Propeller
Fuel filter	Propeller hub kit
Fuel hose and clamps	Wire ties
Assorted hose clamps	Hydraulic steering fluid
Spare bilge pump	Rags
- Make sure all fire extinguishers are in position and in good operating condition.
- Check the engine and steering controls for smooth and proper operation. Be sure the shift control is in the neutral position.
- Be sure the emergency stop lanyard is attached to the operator and the stop switch.
- Refer to the engine owner's manual for pre-operation checks specific to your engine.

2.4 Operating Your Boat

After Starting the Engine:

- Visibly check the engine to be sure there are no apparent water, fuel or oil leaks.
- Check the operation of the engine cooling system by monitoring the water flowing from the bypass ports.
- Check the engine gauges. Make sure they are reading normally.
- Check the controls and steering for smooth and proper operation.
- Make sure all lines, cables, anchors, etc. for securing a boat are on board and in good condition. All lines should be coiled, secured and off the decks when underway.
- Have a safe cruise and enjoy yourself.

Remember:



When you operate a boat, you accept the responsibility for the boat, for the safety of passengers and for others out enjoying the water.

- Alcohol and any drugs can severely reduce your reaction time and affect your better judgement.
- Alcohol severely reduces the ability to react to several different signals at once.
- Alcohol makes it difficult to correctly judge speed and distance or track moving objects.
- Alcohol reduces night vision and the ability to distinguish red from green.

 WARNING 
YOU SHOULD NEVER OPERATE YOUR BOAT WHILE UNDER THE INFLUENCE OF ALCOHOL OR DRUGS.

- Make sure one other person on the boat is instructed in the operation of the boat.
- Make sure the boat is operated in compliance with all state and local laws governing the use of a boat.

 WARNING 
DO NOT OPERATE THE BOAT UNLESS IT IS COMPLETELY ASSEMBLED. KEEP ALL FASTENERS TIGHT. KEEP ADJUSTMENTS ACCORDING TO SPECIFICATIONS.

 WARNING 
FAILURE TO FOLLOW THE BREAK-IN PROCEDURE MAY RESULT IN REDUCED ENGINE LIFE OR EVEN SEVERE DAMAGE IN YOUR OUTBOARD ENGINE. MAKE SURE YOU FOLLOW THE BREAK-IN PROCEDURE EXACTLY.

- Avoid sea conditions that are beyond the skill and experience of you and your crew. Learn to understand weather patterns and indications for change. You should monitor NOAA weather broadcasts before leaving port and periodically while boating. If the weather deteriorates or a storm approaches, seek shelter in a safe harbor.
- Use caution during periods of reduced visibility due to weather or operation conditions. Reduce speed and designate a passenger to be a lookout for other boats, obstacles and navigational markers until you reach port or conditions improve.
- Your Everglades is a heavy boat that will produce a large wake at certain speeds. You are responsible for damage and injury caused by your boat's wake. Always observe No-Wake zones and be aware that your wake can endanger small vessels and their passengers. Always be courteous and slow down to reduce your wake when passing smaller boats.
- Before operating the boat for the first time, read the engine break-in procedures. The break-in procedures are found in the owner's manual for the engine. The manual is in the literature packet.
- As different types of engines are used to power the boat, have the dealer describe the operating procedures for your boat. For more instructions on "How To Operate The Boat," make sure you read the instructions given to you in the owner's manual for the engine you have selected.

Notice:

For more instructions on safety, equipment and boat handling, enroll in one of the several free boating courses offered. For information on the courses offered in your area, call the "Boating Course Hotline," 1-800-368-5647 or on the WEB at www.uscgboating.org.

Notice:

If the running gear hits an underwater object, stop the engine. Inspect the propulsion system for damage. If the system is damaged, contact your dealer for a complete inspection and repair of the unit.

To stop the boat, follow this procedure:

- Allow the engine to drop to idle speed.
- Make sure the shifting lever is in the neutral position.

Notice:

If the engine has been run at high speed for a long period of time, allow it to cool down by running the engine in the idle position for 3 to 5 minutes.

- Turn the ignition key to the "OFF" position.
- Raise the trim tabs to the full up position. Some boats are equipped with trim tabs that will automatically retract when the engine is turned off.

After Operation:

- If operating in saltwater, wash the boat and all equipment with soap and water. Flush the engine using fresh water. Refer to the engine owner's manual for instructions on flushing your outboard engine.
- Check the bilge area for debris and excess water.
- Fill the fuel tank to near full to reduce condensation. Allow enough room in the tank for the fuel to expand without being forced out through the vent.
- Turn off all electrical equipment except the automatic bilge pumps.
- If you are going to leave the boat for a long period of time, put the battery main switch in the "Off" position and close all seacocks.
- Make sure the boat is securely moored.

**CAUTION**

TO PREVENT DAMAGE TO THE BOAT, CLOSE ALL SEACOCKS BEFORE LEAVING THE BOAT.

2.5 Docking, Anchoring and Mooring Docking and Dock Lines

Maneuvering the boat near the dock and securing the boat requires skill and techniques that are unique to the water, wind conditions and the layout of the dock. If possible, position a crew member at the bow and stern to man the lines and assist in docking operations. While maneuvering close to the dock consideration must be given to the wind and current. You should anticipate the effect these forces will have on the boat and use them to help put the boat where you want it. It is important to practice in open water using an imaginary dock enough to develop a sense for the way your boat handles in a variety of docking scenarios. You must be able to foresee the possibilities and have solutions in mind before problems occur.

Approaching a dock or backing into a slip in high winds or strong currents requires a considerable amount of skill. If you are new to boat handling, you should take lessons from an experienced pilot to learn how to maneuver your boat in tight quarters in less than ideal conditions. You should also practice away from the dock during windy conditions.

Dock lines are generally twisted or braided nylon. Nylon is strong and stretches to absorb shock. It also has a long life and is soft and easy on the hands. The line's size will vary with the size of the boat. Typically a 30 to 40 foot boat will use 5/8-inch line and a 20 to 30 foot boat will use 1/2-inch line. The number of lines and their configuration will vary depending on the dock, the range of the tide and many other factors. Usually a combination of bow, stern and spring lines is used to secure the boat.

Maneuvering to the Dock

If your boat is equipped with a joystick integrated into the engine control system, it can be used to maneuver the boat to the dock or back into the slip.

Note, most joystick controls will be deactivated if the throttle & shift control lever is moved while maneuvering the boat.

Electronic control systems and joystick operation is unique to the engine installed on your boat. Operation manuals for the engine and control system are included with this manual. You should read these manuals thoroughly and understand the control system in theory and operation before operating your boat. Additionally, your dealer should demonstrate the operation of the control system and instruct you in operating the controls properly.

Approach the dock slowly at a 30 to 40 degree angle. Whenever possible, approach against the wind or current. Turn the engine straight & shift to neutral when you feel you have enough momentum to reach the dock. Use reverse while turning the steering wheel towards the dock to slow the boat and pull the stern toward the dock as the boat approaches. Straighten the engine and use it to stop the boat if it is still moving forward against the pilings. If you executed your approach properly, the boat will lightly touch the pilings at the same time the forward momentum is stopped. Have the dock lines ready and secure the boat as soon as it stops. Use fenders to protect the boat while it is docked. Keep the engine running until the lines are secured.

Backing into a Slip

Approach the slip with the stern against the wind or current and the engine straight ahead. Use the engine and turn the steering wheel to maneuver the boat into alignment with the slip. Reverse the engine and slowly back into the slip. Shift from reverse to neutral frequently to prevent the boat from gaining too much speed. Move the stern right and left by shifting the engine in and out of gear and turning the wheel in the direction you want the stern to go. When nearly in the slip all the way, straighten the engine and shift to forward to stop. Keep the engine running until the lines are secured.

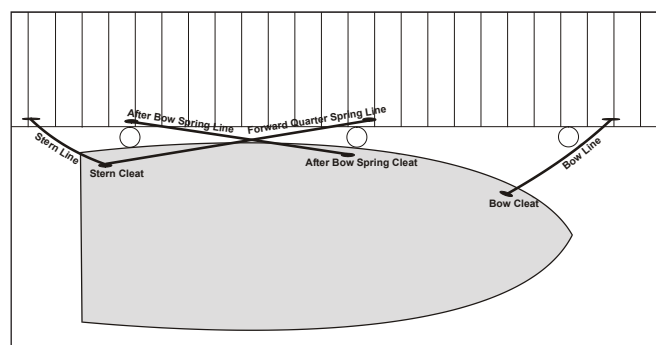

Securing The Boat Along Side A Dock (Typical)

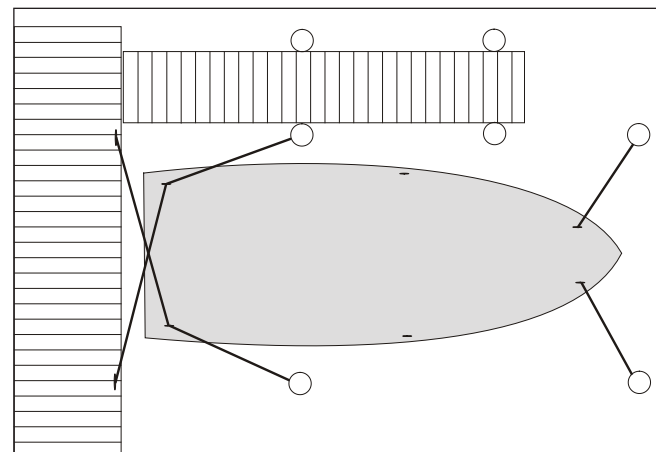

Securing The Boat In A Slip (Typical)

Securing Dock Lines

Securing a boat along side the dock typically requires a bow and stern line and two spring lines. The bow and stern lines are usually secured to the dock at a 40° angle aft of the stern cleat and forward of the bow cleat. The after bow spring line is secured to the dock at a 40° angle aft of the after bow spring cleat. The forward quarter spring is secured to the dock at a 40° angle forward of the stern cleat. The spring lines keep the boat square to the dock and reduce fore and aft movement while allowing the boat to move up and down with the tide.

Securing a boat in a slip is somewhat different. It typically requires two bow lines secured to pilings on each side of the bow, two stern lines secured to the dock and two spring lines that prevent the boat from hitting the dock. The bow lines are typically secured with enough slack to allow the boat to ride the tide. The stern lines are crossed. One line runs from the port aft boat cleat to the starboard dock cleat and the other line runs from the starboard aft boat cleat to the port cleat on the dock. The stern lines center the boat, control the forward motion and allow the boat to ride the

tide. Two forward quarter spring lines typically are secured to the stern cleats and to mid ship pilings or cleats. The spring lines keep the boat from backing into the dock while allowing it to ride the tide.

Leaving the Dock

Always start the engine and let it warm up for several minutes before releasing the lines. Boats steer from the stern and it is important that you achieve enough clearance at the stern to maneuver the boat as quickly as possible. Push the stern off and maneuver such that you get stern clearance quickly. Proceed slowly until well clear of the dock and other boats.

Mooring

Approach the mooring heading into the wind or current. Shift to neutral when you have just enough headway to reach the buoy. Position a crew member on the bow to retrieve the mooring line with a boat hook and secure the line. Keep the engine running until the line is secured.

Leaving a Mooring

Start the engine and let it up for several minutes before releasing the mooring line. The boat will already be headed into the wind, so move it forward enough to loosen the line and untie it. Back the boat away from the mooring until you can see the buoy. Move the boat slowly away from the mooring.

Anchoring

Make sure the bitter end of the anchor line is attached to boat before dropping the anchor. Bring the bow into the wind or current and put the engine in neutral. When the vessel comes to a stop, lower the anchor over the bow. Pay out anchor line so that it is at least 5 to 7 times the depth of the water and secure the line to a cleat. Use caution to avoid getting your feet or hands tangled in the line. Additional scope of 10 times the depth may be required for storm conditions. Check landmarks on shore or your GPS position to make sure the anchor is not dragging. If it is dragging, you will have to start all over. It is prudent to use two anchors at the bow if your are anchoring overnight or in rough weather.

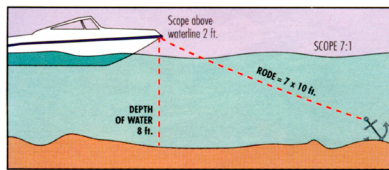



After the anchor is set, the windlass must not be left to take the entire force from the anchor line. Boats lying to their anchor in a high swell or heavy weather conditions will snub on the line. This can cause slippage or apply excessive loads to the windlass. The line should always be made fast to a bow or anchor cleat to relieve the load on the windlass.

Do not set a bow and stern anchor when mooring, only anchor from the bow. The stern anchor will not allow the boat to swing with the current and wind. If your are anchored in a mooring with other boats, your boat will not swing with the other boats in the mooring, creating a potential for contact with another boat when the tide or wind changes. Additionally, having the stern to the wind or tide creates a potentially hazardous situation for the boat and crew.

Releasing the Anchor

Release the anchor by driving the boat slowly to the point where the anchor line becomes vertical. It should release when you pass that point. If the anchor doesn't release right away, stop the boat directly above the anchor and tie the line to the cleat as tight as possible. The up and down movement of the boat will usually loosen the anchor within a minute. Make sure you secure the anchor and properly stow the line before operating the boat.

	CAUTION	
<p>NEVER ANCHOR THE BOAT BY THE STERN. THE STERN OF THE BOAT IS VULNERABLE TO SWAMPING FROM WAVE ACTION. ADDITIONALLY, WIND AND CURRENT WILL PUT MORE STRESS ON THE ANCHOR WHEN IT IS ATTACHED TO THE STERN. ONLY ANCHOR THE BOAT BY THE BOW</p>		

2.6 Controls, Steering or Propulsion System Failure

If the propulsion, control or steering system fails while you are operating the boat, bring the throttle to idle and shift to neutral. Decide whether you need to put out the anchor to prevent the boat from drifting or to hold the bow into the seas. Investigate and correct the problem if you can. Turn the engine off before opening the engine cowling to make repairs. If you are unable to correct the problem, call for help.

2.7 Collision



If your boat is involved in a collision with another boat, dock, piling or a sandbar, your first priority is to check your passengers for injuries and administer first aid if necessary. Once your passengers situations are stabilized, thoroughly inspect the boat for damage. Check below decks for leaks and the control systems for proper operation. Plug all leaks or make the necessary repairs to the control systems before proceeding slowly and carefully to port. Request assistance if necessary. Haul the boat and make a thorough inspection of the hull and running gear for damage.



2.8 Grounding, Towing & Rendering Assistance



The law requires the owner or operator of a vessel to render assistance to any individual or vessel in distress, as long as his vessel is not endangered in the process.

If the boat should become disabled or if another craft that is disabled requires assistance, great care must be taken. The stress applied to a boat during towing may become excessive. Excessive stress can damage the structure of the boat and create a safety hazard for those aboard.

Freeing a grounded vessel or towing a boat that is disabled, requires specialized equipment and knowledge. Line failure and structural damage caused by improper towing have resulted in fatal injuries. Because of this, we strongly suggest that these activities be left to those who have the equipment and knowledge, e.g., the U.S. Coast Guard or a commercial towing company, to safely accomplish the towing task.

	DANGER	
THE MOORING CLEATS ON EVERGLADES BOATS ARE NOT DESIGNED OR INTENDED TO BE USED FOR TOWING PURPOSES. THESE CLEATS ARE SPECIFICALLY DESIGNED AS MOORING CLEATS FOR SECURING THE BOAT TO A DOCK, PIER, ETC. DO NOT USE THESE FITTINGS FOR TOWING OR ATTEMPTING TO FREE A GROUNDED VESSEL.		

	WARNING	
WHEN TOWING OPERATIONS ARE UNDERWAY, HAVE EVERYONE ABOARD BOTH VESSELS STAY CLEAR OF THE TOW LINE AND SURROUNDING AREA. A TOW LINE THAT SHOULD BREAK WHILE UNDER STRESS CAN BE VERY DANGEROUS AND COULD CAUSE SERIOUS INJURY OR DEATH.		

	WARNING	
RUNNING AGROUND CAN CAUSE SERIOUS INJURY TO PASSENGERS AND DAMAGE TO A BOAT AND ITS UNDERWATER GEAR. IF YOUR BOAT SHOULD BECOME GROUNDED, DISTRIBUTE PERSONAL FLOTATION DEVICES AND INSPECT THE BOAT FOR POSSIBLE DAMAGE. THOROUGHLY INSPECT THE BILGE AREA FOR SIGNS OF LEAKAGE. AN EXPERIENCED SERVICE FACILITY SHOULD CHECK YOUR UNDERWATER GEAR AT THE FIRST OPPORTUNITY. DO NOT CONTINUE TO USE YOUR BOAT IF THE CONDITION OF THE UNDERWATER EQUIPMENT IS QUESTIONABLE.		

2.9 Flooding or Capsizing

Boats can become unstable if they become flooded or completely swamped. You must always be aware of the position of the boat to the seas and the amount of water in the bilge. Water entering the boat over the transom can usually be corrected by turning the boat into the waves. If the bilge is flooding because of a hole in the hull or a defective hose, you may be able to plug it with rags, close the thru-hull valve or assist the pumps by bailing with buckets. Put a mayday call in to the Coast Guard or nearby boats and distribute life jackets as soon as you discover your boat is in trouble.

If the boat becomes swamped and capsizes, you and your passengers should stay with the boat as long as you can. It is much easier for the Coast Guard, aircraft or other boats to spot, than people in the water. If your boat is equipped with an EPIRB, make sure it is activated. When activated, EPIRBs will send distress code homing beacons that allow Coast Guard aircraft to identify your boat and find you quickly.

2.10 Fishing

Fishing can be very exciting and distracting for the operator when the action gets intense. You must always be conscious of the fact that your primary responsibility is the safe operation of your boat and the safety of your passengers and other boats in the area. You must always make sure the helm is properly manned and is never left unattended while trolling.

If you are fishing in an area that is crowded with other fishing boats, it may be difficult to follow the rules of the road. This situation can become especially difficult when most boats are trolling. Being courteous and exercising good common sense is essential. Avoid trying to assert your right-of-way and concentrate on staying clear and preventing tangled or cut lines and other unpleasant encounters with other boats. Also keep in mind that fishing line wrapped around a propeller shaft can damage seals in the engine lower unit.

2.11 Man Overboard

If someone falls overboard, you must be prepared to react quickly, particularly when you are offshore. The following procedures will help you in recovering a person that has fallen overboard.

- Immediately stop the boat and sound a man overboard alarm and have all passengers point to the person in the water.
- Circle around quickly and throw a cushion or life jacket to the person, if possible and another to use as a marker.
- Keep the person on the driver side of the boat so you can keep him in sight at all times.
- Make sure to approach the person from the downwind side and maneuver the boat so the propeller is well clear of the person in the water.
- Turn off the engine when the person is alongside and use a ring buoy with a line attached, a paddle or boat hook to assist him to the boat. Make sure you don't hit him with the ring buoy or the boat.
- Pull the person to the boat and assist him on board.
- Check the person for injuries and administer first aid if necessary. If the injuries are serious, call for help. Refer to the Safety chapter for more information on first aid and requesting emergency medical assistance.



WARNING



MOVING PROPELLERS ARE DANGEROUS. THEY CAN CAUSE DEATH, LOSS OF LIMBS OR OTHER SEVERE INJURY. DO NOT USE THE SWIM PLATFORM OR SWIM LADDER WHILE THE ENGINE IS RUNNING. STOP THE ENGINE IF DIVERS OR SWIMMERS ARE ATTEMPTING TO BOARD. ALWAYS PROPERLY STORE THE LADDER BEFORE STARTING THE ENGINE.

2.12 Water Skiing and Wakeboarding

Your boat could be equipped for water skiing and wakeboarding. If you have never driven skiers before, you should spend some hours as an observer and learning from an experienced driver. If you are an experienced driver, you should take some time to become familiar with the boat and the way it handles before pulling a skier. The driver should also know the skier's ability and drive accordingly.

The following safety precautions should be observed while towing water skiers.

- Water ski only in safe areas, away from other boats and swimmers, out of channels and in water free of underwater obstructions. The area should be at least 5 feet deep, 3000 feet long and have at least 100' between each side of the boat and any obstructions.
- Make sure that anyone who skis can swim. Do not allow people who cannot swim to water ski.
- Be sure that the skier is wearing a proper life jacket. A water skier is considered on board the boat and a Coast Guard approved life jacket is required. It is advisable and recommended for a skier to wear a flotation device designed to withstand the impact of hitting the water at high speed.
- Make sure to inspect the ski equipment and tow rope before each ski session. Never use equipment that is damaged or with loose screws, torn boots, severe corrosion or tears in the fabric. You should also inspect the ski tow rope and replace if it is frayed, has unnecessary knots or is damaged. Never use a ski tow line that is questionable.
- Secure the ski tow rope to an appropriate device intended for ski tow ropes.

Operation

- Always carry a second person on board to observe the skier or wakeboarder so that your full attention can be given to the safe operation of the boat. The operator should pay attention to driving the boat and have the observer keep him updated on the skier. Never ski after dark. It is hazardous and illegal. Neither the boat operator or skier can see well enough to navigate at skiing or wakeboarding speeds safely at night.
- Never spray swimmers, boats, rafts or other skiers. The risk for a collision makes this dangerous for the skier and people being sprayed.
- Never follow directly behind another boat while pulling skiers. Always stay a safe distance behind or off the side of other boat traffic. If the boat you are following stops unexpectedly, you may not be able to respond quick enough endangering your skier and occupants of both boats.
- Never follow behind another boat pulling a skier for any reason, even if you are not pulling a skier. If the skier you are following falls, you may not be able to respond quick enough and could run over the skier.
- When pulling multiple skiers, make sure the ropes are the same length. Never pull multiple skiers with tow ropes of different lengths.
- Always make sure to slowly pull the slack out of the ski rope and wait for the OK from the skier before advancing the throttle to ensure the rope is not wrapped around the skier and that the skier is ready. Never advance the throttle until the skier provides the ready signal.
- When turning around to pick up a fallen skier, make sure to look for other boat traffic in the direction of the turn before you turn the boat.
- Approach a skier in the water from the downwind side and be certain to stop the motion of the boat and your motor before coming in close proximity to the skier.
- Give immediate attention to a fallen skier. A fallen skier is very hard to see by other boats and is extremely vulnerable. When a skier falls, be prepared to immediately turn the boat and return to the skier.
- Never leave a fallen skier alone in the water for any reason and have an observer display a skier down flag to alert other boaters that your skier has fallen.

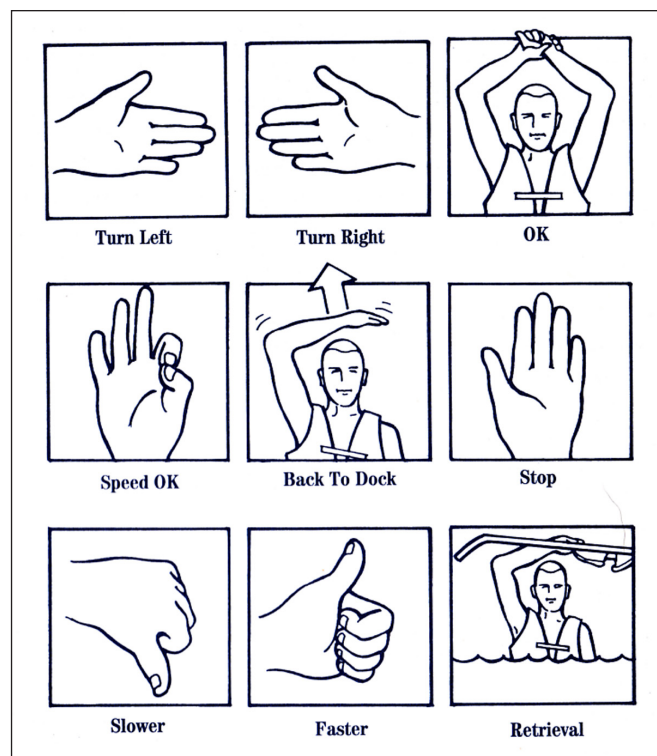

Common Hand Signals for Water Sports Activities

- Agree on hand signals to be used between the observer and skier to communicate. This is important to eliminate confusion and ensure the safety of your skiers, wakeboarders or tubers. Refer the Hand Signals drawing in this section for signals that are commonly used during water sports activities.
- Make sure the observer watches for the skier's signal to indicate he or she is OK. If the signal is not seen immediately, assume the skier is injured and in need of immediate assistance. Be prepared to respond quickly.
- For additional information on water skiing, including hand signals and water skiing manuals, contact the American Water Skiing Association in Winter Haven, Florida, 813-324-4341.



WARNING



MOVING PROPELLERS ARE DANGEROUS. THEY CAN CAUSE DEATH, LOSS OF LIMBS OR OTHER SEVERE INJURY. DO NOT USE THE SWIM PLATFORM OR SWIM LADDER WHILE THE ENGINE IS RUNNING. STOP THE ENGINE IF DIVERS, SWIMMERS OR SKIERS ARE ATTEMPTING TO BOARD. ALWAYS PROPERLY STORE THE LADDER BEFORE STARTING THE ENGINE.

Operation

2.13 Maximum Capacities Plate

Coast Guard rules require boats less than 20 feet (6 meters) to display a gross weight and person-capacity plate provided by the manufacturer.

Boat manufacturers in the National Marine Manufacturers Association (NMMA) program will display a gross weight and person-capacity plate on boats up to 26 feet (7.9 meters).

The person/load capacity is determined by the US Coast Guard. The capacity plate is usually located near the helm in clear view of the operator. The limits indicated on the capacity plate are enforceable by law.

You should never exceed the "U.S. Coast Guard Maximum Capacities" indicated on the capacity plate.

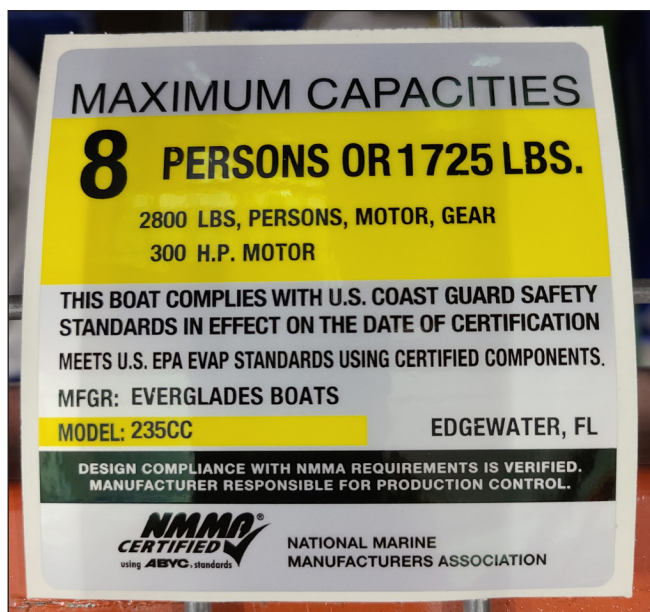

Typical Maximum Capacity Plate

2.14 Trailering Your Boat

If you trailer your boat, make sure that your tow vehicle is capable of towing the weight of the trailer, boat and equipment and the weight of the passengers and equipment inside the vehicle. This may require that the tow vehicle be specially equipped with a larger engine, transmission, brakes and trailer tow package. Additionally, the laws in your state may require special permits to tow a large boat on some or all highways.

The boat trailer is an important part of your boating package. The trailer should be matched to your boat's weight and hull. Using a trailer with a capacity too low will be unsafe on the road and cause abnormal wear. A trailer with a capacity too high, can damage the boat. Contact your dealer to evaluate your towing vehicle and hitch and to make sure you have the correct trailer for your boat.

Important Note:

Your Everglades is a heavy boat and care must be taken when selecting the trailer. We recommend that you use a bunk style trailer that incorporates a combination of heavy duty rollers or bunks, to support the keel and long bunks running under and parallel to the stringers to support the hull. Avoid using a full roller trailer that does not have bunks. Roller trailers have a tendency to put extreme pressure points on the hull, especially on the lifting strakes and have damaged boats. The situation is worse during

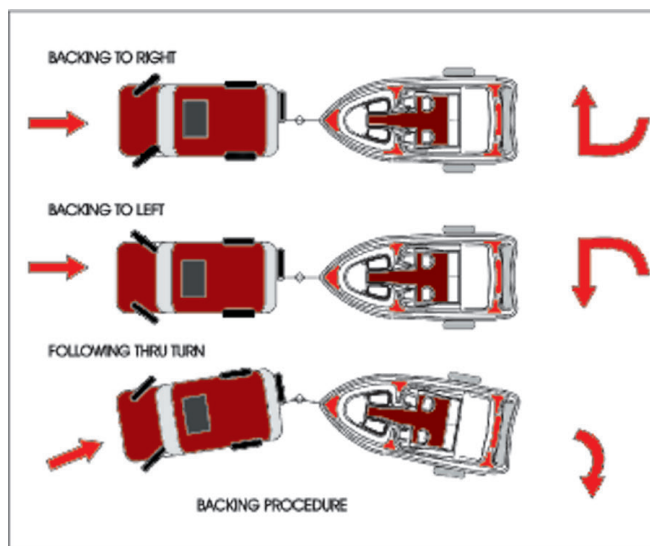

Backing Procedure for Boat Trailers

launching and haul out. Damage resulting from improper trailer support or the use of a full roller trailer will not be covered by the Everglades Warranty.

Notice:



Contact your trailer dealer to evaluate your towing vehicle and hitch and to make sure you have the correct trailer for your boat.

Operation

- Make sure the trailer is a match for your boat's weight and hull design. More damage can be done to a boat by the stresses of road travel than by normal water operation. A boat hull is designed to be supported evenly by water. So, when it is transported on a trailer it should be supported structurally as evenly across the hull as possible allowing for even distribution of the weight of the hull, engine and equipment.
- Make sure the trailer bunks and/or rollers properly support the hull and do not put pressure on the lifting strakes. The rollers and bunks must be kept in good condition to prevent scratching and gouging of the hull.
- The capacity rating of the trailer should be greater than the combined weight of the boat, motor and equipment. The gross vehicle weight rating must be shown on the trailer. Make sure the weight of the boat, engine, gear and trailer is not more than the gross vehicle weight rating.
- Make sure the boat is securely fastened on the trailer to prevent movement between the boat and trailer. The bow eye on the boat should be secured with a rope, chain or turnbuckle in addition to the winch cable or strap. Additional straps may be required across the beam of the boat or from the transom eyes to the trailer.
- Lower the console windshield and secure it in the down position. Extreme wind pressure encountered at highway speeds may cause damage to the windshield if it is in the up position.
- Make sure the tow BALL and TRAILER COUPLER are the same size and bolts and nuts are tightly secured.
- The COUPLER MUST BE COMPLETELY OVER THE BALL and the LATCHING MECHANISM LOCKED DOWN.
- Make sure the TRAILER IS LOADED EVENLY from front to rear as well as side to side and has the correct weight on the hitch. Too much weight on the hitch will cause the rear of the tow vehicle to drag and may make steering more difficult. Too little weight on the hitch will cause the rig to fishtail and will make controlling the tow vehicle difficult. Contact the trailer manufacturer or your dealer for the correct weight on the hitch for your trailer.
- The SAFETY CHAINS must be attached crisscrossing under the coupler to the frame of the tow vehicle. If the ball was to break, the trailer would follow in a straight line and prevent the coupler from dragging on the road. Make sure the trailer emergency brake cable or chain is also installed to the tow vehicle frame.

Notice:

Your dealer will give instructions on how to load, fasten and launch your boat.

	CAUTION	
<p>BOATS HAVE BEEN DAMAGED BY TRAILERS THAT DO NOT PROPERLY SUPPORT THE HULL. ALWAYS MAKE SURE THE TRAILER BUNKS AND ROLLERS ARE ADJUSTED SO THEY ARE NOT PUTTING EXCESSIVE PRESSURE ON THE LIFTING STRAKES AND ARE PROVIDING ENOUGH SUPPORT FOR THE HULL. HULL DAMAGE RESULTING FROM IMPROPER TRAILER SUPPORT IS NOT COVERED BY THE EVERGLADES WARRANTY.</p>		

Before Going Out On The Highway:

- Side curtains, clear connector, backdrop and aft curtain must be removed when trailering. Canvas enclosures are not designed to withstand the extreme wind pressure encountered while trailering and will be damaged. Always remove and properly store the enclosure before trailering your boat.
- Make sure the LIGHTS on the trailer function properly.
- CHECK THE BRAKES. On a level parking area roll forward and apply the brakes several times at increasing speeds to determine if the brakes on the tow vehicle and trailer are working properly.
- Make sure the tow vehicle has SIDE VIEW MIRRORS that are large enough to provide an unobstructed rear view on both sides of the vehicle.
- CHECK THE TIRES and WHEEL BEARINGS.

Notice:

Make sure your towing vehicle and trailer are in compliance with all state and local laws. Contact your state motor vehicle bureau for laws governing the towing of trailers.

NOTES

PROPULSION SYSTEM

3.1 General

Your boat is designed to be powered with a 4-cycle outboard motor. These engines have an oil sump in the crankcase that must be kept full of the type of oil recommended by the engine manufacturer. The oil must be checked before each use and changed regularly.

Each manufacturer of the various outboard motors provides an owner's information manual with its product. It is important that you read the manual(s) very carefully and become familiar with the proper care and operation of the engine and drive system. A warranty registration card has been furnished with each new engine and can be located in the engine owner's manual. All information requested on this card should be filled out completely by the dealer and purchaser and then returned to the respective engine manufacturer as soon as possible.



Outboard Power System



WARNING



DO NOT ATTEMPT TO SERVICE ANY ENGINE OR DRIVE COMPONENT WITHOUT BEING TOTALLY FAMILIAR WITH THE SAFE AND PROPER SERVICE PROCEDURES. CERTAIN MOVING PARTS ARE EXPOSED AND CAN BE DANGEROUS TO SOMEONE UNFAMILIAR WITH THE OPERATION AND FUNCTION OF THE EQUIPMENT.



WARNING



DO NOT INHALE EXHAUST FUMES! EXHAUST CONTAINS CARBON MONOXIDE THAT IS COLORLESS AND ODORLESS. CARBON MONOXIDE IS A DANGEROUS GAS THAT IS POTENTIALLY LETHAL.

3.2 Drive System Corrosion

Each outboard motor is a complete drive system with the gear case being just forward of the propeller and connected to the power head with a vertical drive shaft. All engines require some maintenance. Routine maintenance recommended for your engine is outlined in the engine owner's manual. Routine maintenance is normally the primary concern unless the boat is to be kept in saltwater for extended periods of time. Then the

main concerns are marine growth and galvanic corrosion.

Marine growth occurs when components are left in the water for extended periods and can cause poor performance or permanent damage to the exposed components. The type of growth and how quickly it occurs is relative to the water conditions in your boating area. Water temperature, pollution, current, etc. can have an effect on marine growth.

Galvanic corrosion is the corrosion process occurring when different metals are submerged in an electrolyte. Seawater is an electrolyte and submerged engine components must be properly protected. Outboard motors are equipped with sacrificial anodes to prevent galvanic corrosion problems. The anodes must be monitored and replaced as necessary. For locations and maintenance, refer to the engine owner's manual.

When leaving the boat in the water, tilt the motors as high as possible. This will decrease the risk of marine growth around the cooling inlets, propeller and exhaust ports and damage from galvanic corrosion.



CAUTION



DO NOT PAINT THE OUTBOARD MOTOR WITH ANTI-FOULING PAINTS DESIGNED FOR BOAT HULLS. MANY OF THESE PAINTS CAN CAUSE SEVERE DAMAGE TO THE ENGINE. CONTACT YOUR EVERGLADES DEALER OR ENGINE MANUFACTURER FOR INFORMATION ON THE PROPER PAINTING PROCEDURES.

3.3 Engine Lubrication

Engine Lubrication

4-cycle outboard engines incorporate a pressure-type lubrication system with an oil sump in the crankcase that must be kept full of the type and grade of oil recommended by the engine manufacturer. It is normal for 4-cycle engines to consume a small amount of oil. Therefore, the oil must be checked before each use and changed at regular intervals as instructed by the engine owner's manual.

Notice:

Always monitor the oil level in the crankcase and only use the type of oil specified by the engine manufacturer.

3.4 Engine Cooling System

Outboard engines are raw water (seawater) cooled. Water is pumped through the water inlets, circulated through the engine block and relinquished with the exhaust gases through the propeller hub. The water pump uses a small impeller made of synthetic rubber. The impeller and water pump cannot run dry for more than a few seconds. In most outboard motors, some cooling water is diverted through ports below the engine cowling. This allows the operator to visually check the operation of the cooling system. When the engine is started, always check for a steady stream of water coming out of those ports.

Notice:

If the boat is used in salt or badly polluted water, the engine should be flushed after each use. Refer to the engine owner's manual for the proper engine flushing procedure.



CAUTION



NEVER RUN AN OUTBOARD MOTOR WITHOUT WATER FLOWING TO THE WATER PUMP. SERIOUS DAMAGE TO THE WATER IMPELLER OR ENGINE COULD RESULT.



Typical Yamaha Propeller

3.5 Propellers

Propellers convert the engine's power into thrust. They come in a variety of styles, diameters and pitches. All boats powered by Yamaha engines are equipped with Yamaha propellers. The one that will best suit the needs of your boat will depend somewhat on your application and expected average load. Propeller sizes are identified by two numbers stamped on the prop in sequence. The 1st number in the sequence (example 14" x 21") is the diameter of the propeller and the 2nd number is the pitch. Pitch is the theoretical distance traveled by the propeller in each revolution.

Always repair or replace a propeller immediately if it has been damaged. A damaged and therefore out of balance propeller can cause vibration that can be felt in the boat and could damage the engine gear assembly. Refer to the engine owner's manual for information on propeller removal and installation.

3.6 Performance Issues and Propellers

It is extremely important that the boat is propped to run at or very near the recommended top RPM with an average load. If the top RPM is above or below the recommend range, the propeller must be changed to prevent loss of performance and possible engine damage.

Notice:

Before changing a propeller to correct boat performance problems, be sure other factors such as engine tuning, bottom and running gear growth, etc. are not the source of performance changes. Always be sure the load conditions are those normally experienced, before changing the propeller.

Your boat was shipped with a propeller that typically provides optimum performance for your boat. However there are factors that can affect performance and propeller requirements.

Some are as follows:

- You should be sure the load conditions are those normally experienced. If the boat ran in the required RPM range when it was new and you have not added any additional gear or heavy equipment and have not damaged the propeller, there is a good chance the propeller is not the problem.
- The addition of heavy equipment like life rafts, additional coolers, etc., will cause additional load on the engine. Consequently, a different propeller may be required.
- Boats operated at high altitudes (above 2000 feet). Engines operated at high altitudes will not be able to develop as much horsepower as they do at or near sea level. Consequently, a different a propeller may be required.

Notice:

Outboard engines can be damaged and the engine warranty void if the boat is not propped correctly. Always consult your Everglades dealer or authorized engine service dealer when making changes to the propeller or if the boat does not run near the top recommended RPM.

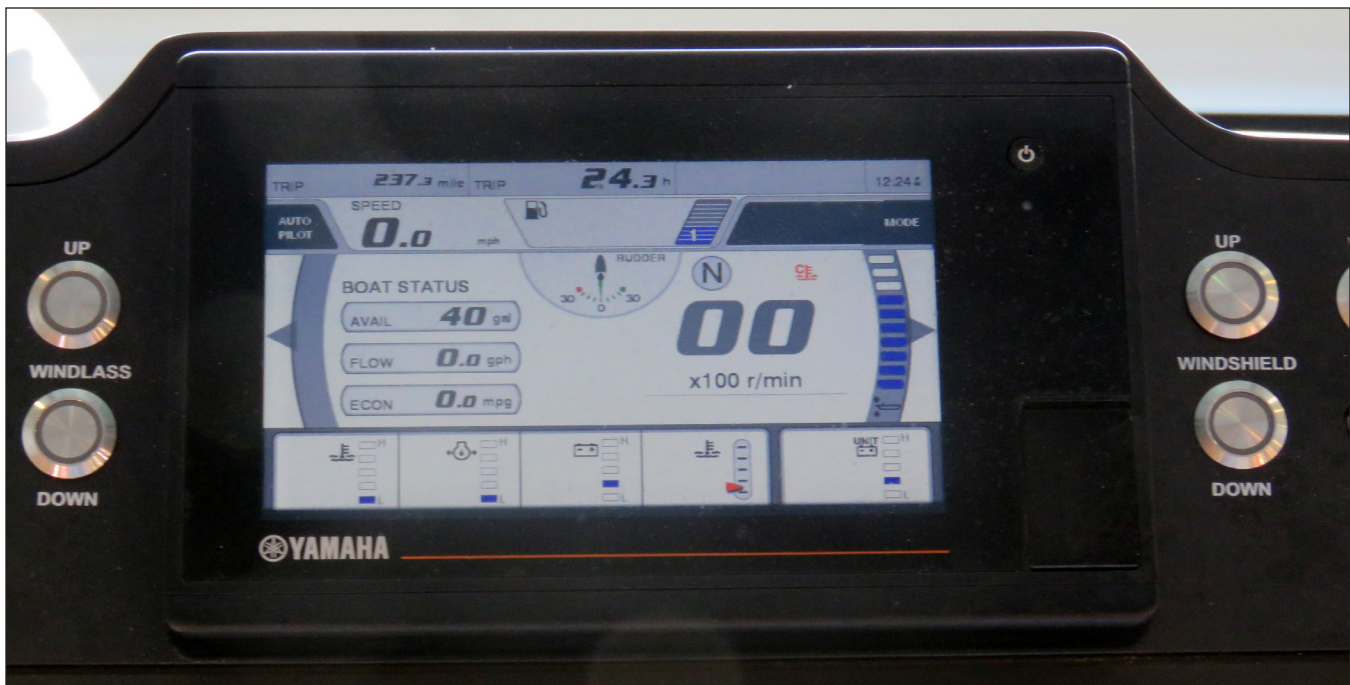

Yamaha Helm Master CL7 Display

3.7 Engine Instrumentation

The helm station is equipped with engine instruments and alarms. These instruments allow the operator to monitor the operational condition of the engine. Close observation of these instruments allows the operator to operate the engine at the most efficient level and could save it from serious costly damage. The instrumentation is unique to the type of outboard motor and optional equipment installed on your boat.

Most Everglades boats are equipped with Yamaha engines and Helm Master EX touch screen multifunction instruments. These systems can be integrated with optional electronic navigation equipment installed on your boat. A brief description of the Yamaha integrated gauges and their basic functions are listed in this section. Other functions that are dependent on the electronics installed on your boat may be available. Refer to the Yamaha engine and Helm Master EX owner's manuals and the manuals for the electronics installed on your boat for detailed information on the operation of the instruments and additional functions available.

Some or all of the following gauges may be present.

Tachometer

The tachometer displays the speed of the engine in revolutions per minute (RPM). This speed is not the boat speed or necessarily the speed of the propeller.

With Helm Master CL7 touch screens, the tachometer display also contains the engine trim meter, oil pressure indicator, water pressure, water temperature, volt meter, speed, fuel flow and the overheat warning indicator. Other gauges may be displayed, depending on the options selected.

⚠ **CAUTION** ⚠

NEVER EXCEED THE MAXIMUM RECOMMENDED OPERATION RPM OF THE ENGINE. MAINTAINING MAXIMUM OR CLOSE TO MAXIMUM RPM FOR EXTENDED PERIODS CAN REDUCE THE LIFE OF THE ENGINE.

Speedometer

Yamaha speedometers indicate boat speed via the engine pickup or an optional GPS or depth sounder triducer, if these optional electronics are installed in your boat. Refer to the engine gauge and electronics operating manuals for more information on the speedometer options available for your boat.

Temperature Gauge



The temperature gauge indicates the temperature of the engine cooling system. A sudden increase in the temperature could signal a blocked cooling passage or a water pump malfunction.

Overheat Warning Indicator

The temperature warning indicates that the temperature of the engine is too high. A sudden increase in the temperature could indicate an obstructed water inlet or an impeller failure.

With Helm Master EX CL7 instruments, the overheat warning indicator is built into the touchscreen display.

The warning indicator will start to blink and sound an alarm if the engine temperature is too high.

	CAUTION	
CONTINUED OPERATION OF AN OVERHEATED ENGINE CAN RESULT IN ENGINE SEIZURE. IF AN UNUSUALLY HIGH TEMPERATURE READING OCCURS, SHUT THE ENGINE OFF IMMEDIATELY. THEN INVESTIGATE AND CORRECT THE PROBLEM.		

Fuel Gauge

The fuel gauge indicates the amount of fuel in the fuel tank.

With Helm Master EX CL7 instruments, the fuel gauge is built into the touchscreen display.

The fuel indicator on the display will begin to blink if fuel in the tank drops too low.

Voltmeter

The voltmeter displays the voltage for the battery and the charging system. The normal voltage is 12 to 12.5 volts with the engine off and 13 to 14.5 volts with the engine running.

With Helm Master EX CL7 instruments, the voltmeter is built into the touchscreen display.

The voltmeter display will begin to blink if the voltage in the battery drops too low.

Hour Meter

The hour meter keeps a record of the operating time for the engine.

Engine Tilt/Trim Gauge



The tilt/trim gauge monitors the position of the outboard engine. The upper range of the gauge indicates the tilt, which is used for trailering and shallow water operation. The lower range indicates the trim position. This is the range used to adjust the hull angle while operating your boat on plane.

With Helm Master EX CL7 instruments, the tilt/trim gauge is built into the touchscreen display.

Refer to the engine and instrument owner's manuals for more information on the operation of the outboard power tilt and trim.

Engine Alarm

All outboard engines are equipped with an audible alarm system mounted in the helm area that monitors selected critical engine systems. The alarm will sound if one of these systems begins to fail. Refer to the engine owner's manual for information on the alarms installed with your engine.

	CAUTION	
IF THE ENGINE ALARM SOUNDS, IMMEDIATELY SHUT OFF THE ENGINE UNTIL THE PROBLEM IS FOUND AND CORRECTED.		

Propulsion System

Fuel Management

Fuel management systems are standard equipment with most outboard engines. On Yamaha engines, the fuel management gauge is built into the Helm Master EX display and can monitor miles per gallon, total gallons used and total gallons remaining.

Refer to the engine or instrument manuals for detailed information on that system.

Depth Gauge (Optional)

The depth gauge indicates the depth of the water below the bottom of the boat.

Compass

All boats are equipped with a compass on the top of the instrument panel. The compass cannot be adjusted accurately at the factory as it must be compensated for the influence of the electrical equipment and electronics unique to your boat. Therefore, the compass should be adjusted by a professional after the electronics and additional electrical accessories are installed and before operating the boat. To adjust the compass for your area, read the instructions on "Compass Compensation" given to you in the literature packet.

Instrument Maintenance

Electrical protection for instruments and ignition circuitry is provided by a set of fuses or circuit breakers located on the engine. The ignition switch should be sprayed periodically with a contact cleaner/lubricant. The ignition switch and all instruments, controls, etc. should be protected from the weather when not in use. Excessive exposure can lead to gauge and ignition switch difficulties.



Compass

HELM CONTROL SYSTEMS

4.1 General

The helm controls consist of three systems: the engine throttle and shift control, the steering system and the trim tab control switches. These systems provide the operator with the ability to control the direction and attitude of the boat from the helm station.

Each manufacturer of the control components provides an owner's manual with its product. It is important that you read the manuals and become familiar with the proper care and operation of the control systems.

4.2 Engine Throttle and Shift Controls

The shift and throttle control on your boat may vary depending on the engine used. The following control description is typical of most cable and electronic outboard remote controls. Refer to the engine or control manuals for specific information on the controls installed on your Everglades.

Cable Engine Control

The engine throttle and shift control system consists of three major components: the control handle, the throttle cable and the shift cable. The cables are all the push-pull type. Two cables are required for each engine. One cable connects the remote throttle control to the carburetor or fuel injectors and the other connects the remote shift control to the engine shift linkage.

The helm on your Everglades is designed for a binnacle style control with a single lever that operates as a gear shift and a throttle. General operation will include a position for neutral (straight up and down), a forward position (the 1st detent forward of neutral) and a reverse position (the 1st detent aft of neutral). Advancing the control lever beyond the shift range advances the throttle in forward or reverse. Each control is equipped with a means of permitting the engine to be operated at a higher than idle RPM while in neutral for cold starting and warm-up purposes.



Typical Yamaha Single Engine Electronic Control

Electronic Engine Control

Electronic engine controls are optional on most outboard engines. The following control description is typical of most electronic control installations.

The helm is designed for a binnacle style control with a single lever. The electronic control system consists of three major components: the electronic control head, instruments and keypad, the control processors and applicable harnesses. The controls are completely electronic and there are no cables. The controls have a single lever for the engine that operates as a gearshift and a throttle. General operation will include a position for neutral (straight up and down or slightly aft of vertical),

a forward position (the 1st detent forward of neutral) and a reverse position (the 1st detent aft of neutral). Advancing the control lever beyond the shift range advances the throttle in forward or reverse. Each control is equipped with a means of permitting the engine to be operated at a higher than idle RPM while in neutral for cold starting and warm-up purposes. The control lever is equipped with an adjustable control head detent and friction settings.

The engine control and key pad has integrated switches and indicator lights which allow the operator to control all aspects of the boat's propulsion system. LED lights on the control indicate that the control is activated and the engine can be started.

The most common features activated or monitored by the keypad are:

- Starter lockout, which prevents the engine from being started in gear.
- Gear lockout, which allows the engine RPM to be advanced in neutral safely.
- Battery voltage warning indicator that warns the operator of high or low voltage supplied to the system (audible alarm).
- Trolling feature that allows the operator to increase the engine speed in 50 RPM increments while operating at trolling speeds between 600 - 1000 RPM.
- Station selection that allows the operator to transfer control from one station to another with the push of a button on boats with two helm stations. Each station must be selected by the operator before the controls will operate from that station.

These features and others not mentioned require specific procedures to activate and operate them properly. Some of the procedures and features are unique to the engine and other options installed on your boat. It is essential that you read the owner's manual for the controls and be completely familiar with their operation before using your boat.



CAUTION



ALWAYS RETURN THE ENGINE THROTTLE LEVER TO THE EXTREME LOW SPEED POSITION BEFORE SHIFTING. NEVER SHIFT THE UNIT WHILE ENGINE SPEED IS ABOVE IDLE RPM.



Typical Yamaha Station Transfer Button

4.3 Neutral Safety Switch

Every control system has a neutral safety switch incorporated into it. This device prohibits the engine from being started while the shift lever is in any position other than the neutral position. If the engine will not start, slight movement of the shift lever may be necessary to locate the neutral position and disengage the safety cutout switch. Control or cable adjustments may be required to correct this condition should it persist. See your Everglades dealer for necessary control and/or cable adjustments.

The neutral safety switch should be tested periodically to ensure that it is operating properly. To test the neutral safety switch, make sure the engine is tilted down and move the shift lever to the forward position.



Make sure the throttle control lever is not advanced past the idle position. Press the start button or turn the key just long enough to briefly engage the starter for the engine.

Notice:

Most outboard control systems are equipped with a computer controlled start feature that will keep the starter engaged until the engine starts if the neutral safety switch fails and allows the starter to engage.

Helm Control Systems

The starter should not engage. Repeat this test with the shift lever in reverse and the engine throttle at idle. Again, the starter should not engage. If the starter engages with the shift control in any position other than the neutral position, then the neutral safety switch is not functioning properly and you should contact your dealer to have the neutral safety switch repaired before using your boat. If the engine starts in gear during this test, immediately move the control lever to the neutral position.

	WARNING	
<p>IN SOME SITUATIONS, IT MAY BE POSSIBLE TO ACCIDENTALLY START THE ENGINE IN GEAR WITH THE THROTTLE ABOVE IDLE IF THE NEUTRAL SAFETY SWITCH IS NOT OPERATING PROPERLY. THIS WOULD CAUSE THE BOAT TO ACCELERATE UNEXPECTEDLY IN FORWARD OR REVERSE AND COULD RESULT IN LOSS OF CONTROL, DAMAGE TO THE BOAT OR INJURY TO PASSENGERS. ALWAYS TEST THE NEUTRAL SAFETY SWITCH PERIODICALLY AND CORRECT ANY PROBLEMS BEFORE USING THE BOAT.</p>		

4.4 Engine Power Tilt and Trim



All outboard engines have a tilt and trim feature. Most outboard engines have a tilt/trim switch built into the engine shift and throttle control that allows the operator to control the position of the outboard from the helm.

Moving the outboard closer to the boat transom is called trimming "in" or "down." Moving the outboard further away from the boat transom is called trimming "out" or "up." In most cases, the boat will run best with the outboard adjusted so the hull will run at a 3 to 5 degree angle to the water.

The term "trim" generally refers to the adjustment of the outboard within the first 20° range of travel. This is the range used while operating your boat on plane. The term "tilt" is generally used when referring to adjusting the outboard further up for shallow water operation or trailering. For information on the proper use and maintenance of the power tilt and trim, refer to the engine owner's manual.



Typical Power Tilt & Trim Switch

	CAUTION	
<p>ENGINE HOSES AND CABLES OR THE TRANSM GEL COAT CAN BE DAMAGED BY TILTING THE ENGINE TO THE FULL UP POSITION WITH THE ENGINE TURNED TO THE WRONG POSITION. MOST BOATS REQUIRE THE STEERING WHEEL TO BE TURNED COMPLETELY TO STARBOARD BEFORE TILTING THE ENGINE TO THE FULL UP POSITION. YOU SHOULD MONITOR THE ENGINE AS IT TILTS TO DETERMINE BEST FULL TILT ENGINE POSITION FOR YOUR BOAT.</p>		



CAUTION



SOME AFTERMARKET AUTOPILOTS HAVE ENGINE POSITION SENSORS THAT ARE MOUNTED TO THE HYDRAULIC STEERING CYLINDER. WITH SOME OF THESE AUTOPILOTS, THE ENGINE POSITION SENSOR BRACKET COULD HIT THE TRANSOM WHEN THE ENGINE IS TILTED TO THE FULL UP POSITION AND CAUSE DAMAGE TO THE ENGINE RIGGING, THE AUTOPILOT OR THE TRANSOM. IF YOU HAVE AN AUTOPILOT INSTALLED ON YOUR BOAT, YOU SHOULD MONITOR THE LOCATION OF THE ENGINE CABLES AND AUTOPILOT BRACKETS AS THE ENGINE IS TILTED TO DETERMINE THE BEST ENGINE POSITION AND MAXIMUM ENGINE TILT FOR YOUR APPLICATION.

4.5 Engine Stop Switch

Your boat is equipped with an engine stop switch and lanyard. When the lanyard is pulled it will engage the switch and shut off the engine. We strongly recommend that the lanyard be attached to the driver whenever the engine is running. If the engine will not start, it could be because the lanyard is not properly inserted into the engine stop switch. Always make sure the lanyard is properly attached to the engine stop switch before attempting to start the engine.

Refer to the engine owner's manual for more information on the engine stop switch.



Typical Yamaha Engine Stop Switch & Lanyard

4.6 Steering System

Power Assist Hydraulic Steering

A power assisted steering system is standard equipment on most boats. The system is comprised of two hydraulic circuits: a manual system, which is the control element, and a hydraulic power assist pump, which is the working element.

The manual system is hydraulic and made of three main components: the helm assembly, hydraulic hoses and the steering cylinder. The fluid reservoir for the system is built into the power assist pump assembly and the helm acts as a pump. Turning of the steering wheel, pumps fluid through the hydraulic hoses and activates the hydraulic steering cylinder causing the motor to turn. A slight clicking sound may be heard as the wheel is turned. This sound is the opening and closing of valves in the helm pump unit and is normal.

The power system is an electronically controlled, 12 volt hydraulic pump that boosts the fluid pressure being sent from the helm pump to the steering cylinder to provide "Power" for the steering system which results in much easier effort at the steering wheel, even under heavy loads. In the event of a power loss or failure of the hydraulic assist pump, the steering system will automatically revert to a manual hydraulic system. The manual system operates as described previously in this section and will require more effort on the steering wheel to turn the motor.

Hydraulic Steering Cylinder

Single outboard engines with hydraulic steering are equipped with one hydraulic steering cylinder mounted on the engine that is connected directly to the engine tiller arm.

Electronic Steering (Optional)

Your boat is equipped with an electronic steering system that provides precise and responsive steering. The system is 100% electronic and there are no mechanical connections between the steering wheel and the engine.

For safety and improved tight quarter maneuvering, the controlling software on most systems senses engine speed and adjusts maximum steering angle and steering wheel resistance to preset limits as engine speed increases or decreases. Steering angles and steering wheel resistance at specific engine speeds are programmed into the system at the factory and are not adjustable. Should a fault in the steering system occur, the

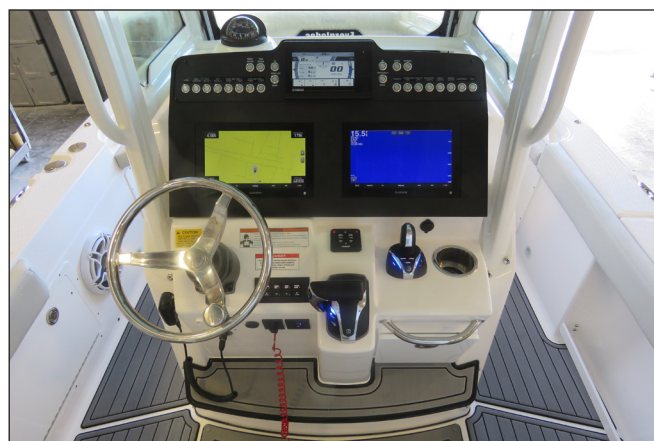

Helm Station Steering Wheel



Engine Steering Servo

controlling software will sense the failure, limit engine RPM as a safety precaution and alert the operator.

Each steering control system has emergency procedures that are specific to the steering system and type of failure. It is very important to follow the correct procedure to avoid damage to the boat if a steering system failure occurs.

Refer to the engine or steering system owner's manuals for specific information on the operation, maintenance and emergency procedures for the steering system installed in your boat.

Steering Servo

Single outboard engines with electronic steering are equipped with one steering servo mounted on the engine that is connected directly to the engine tiller arm.

Tilt Steering Wheel

The steering wheel can be tilted to five different positions by activating the tilt lock lever located on the bottom of the helm station. When the lever is released, it automatically locks the steering wheel at or close to that angle. Refer to the steering manufacturer owner's manual for specific information on the steering system.

4.7 Joystick Control

A joystick control system is an option on some engine installations with electronic steering. The joystick can only be used at slow speeds. It is engaged by moving the shift and throttle control to the neutral position and pressing a button on the base of the joystick control or the keypad on the main engine controls. Once activated, the boat moves in the direction the joystick is pushed with the engine speed increasing the further the stick is pushed, up to preset limits. Turning the knob on the top of the joystick rotates the boat in the direction the knob is turned. Another button on the joystick or engine control keypad raises the preset engine speed for maneuvering in high winds and/or strong tides.

When the joystick is released, it automatically returns to center, the engine shifts to neutral, rotate to the straight ahead position, and the engine speed is reduced to idle. It is deactivated by pressing the button at the base of the joystick or control keypad or by moving the shift and throttle control levers.

Always refer to the engine manufacturer owner's manuals for specific information on the operation and maintenance for the joystick and steering control systems on your boat.



Tilt Steering Wheel



Yamaha Helm Master EX Joystick



DANGER



SOME JOYSTICKS AND ELECTRONIC CONTROL SYSTEMS ARE EQUIPPED WITH A SKYHOOK OR STAYPOINT FEATURE WHICH USES THE ENGINE TO AUTOMATICALLY HOLD THE BOAT IN POSITION. THIS FEATURE CAN CAUSE SERIOUS INJURY OR DEATH TO PERSONS SWIMMING NEAR THE BOAT OR ATTEMPTING TO BOARD WHEN IT IS ACTIVATED.

WHEN THE SKYHOOK OR STAYPOINT FEATURE IS ACTIVATED:

- THE PROPELLER ROTATES AUTOMATICALLY;
- PROPELLER ROTATION MAY NOT BE OBVIOUS;
- THE BOAT MAY SUDDENLY MOVE IN ANY DIRECTION;
- THE PROPELLER CAN INJURE PEOPLE IN THE WATER ANYWHERE AROUND THE BOAT.



DANGER



IF YOUR BOAT IS EQUIPPED WITH SKYHOOK OR STAYPOINT, THE FOLLOWING PRECAUTIONS APPLY:

- ALWAYS ASK THE CAPTAIN BEFORE ENTERING THE WATER.

UNLESS THE CAPTAIN GIVES YOU PERMISSION:

- DO NOT GO IN THE WATER; WIND OR WATER CURRENT CAN MOVE SWIMMERS INTO THE PROPELLER.
- DO NOT SIT OR STAND WHERE YOU COULD FALL OVERBOARD; YOU MAY LOSE YOUR BALANCE IF THE BOAT MOVES SUDDENLY.

4.8 Trim Tabs

The trim tabs are mounted on the transom below the engine mounting system. A dual rocker switch is used to control the trim tabs. The switch controls bow up and down movements. It also controls starboard and port up and down movements. Bow up and bow down will control the hull planing attitude, while port and starboard up and down provides control for the hull listing. Before leaving the dock or loading the boat on a trailer or forklift, make sure that the tabs are in the full "UP" position by holding the control in the bow up position for ten (10) seconds.

LED Indicator Switch

The red LED lights next to each switch display the position of your trim tabs. Additionally, the switch is wired so the trim tabs automatically retract to the "full-up" position when the ignition switch is turned off.

The LED display indicates trim tab deflection. When one LED indicator light is lit at the top of each display, the tabs are in the "full-up" (bow up) position. As the tabs are lowered (bow down) additional indicator LED lights become lit to indicate the degree of tab plane travel. When all LED lights are lit, the tabs are fully extended (bow down).



Typical Trim Tab Switches



Trim Tab Plane & Cylinder

CAUTION

THE TRIM TABS CAN BE DAMAGED BY BOAT TRAILERS IF THE BUNKS EXTEND BEYOND THE TRANSOM OR THE BOAT IS NOT CENTERED PROPERLY. THEY CAN ALSO BE DAMAGED BY FORK LIFTS AT DRY STACK MARINAS DURING LIFTING. TO REDUCE THE POSSIBILITY OF DAMAGE, ALWAYS MAKE SURE THE TABS ARE IN THE FULL UP POSITION BEFORE LOADING YOUR BOAT ON A TRAILER OR HAVING IT LIFTED BY A FORK LIFT.

Trim Tab Operation

Before leaving the dock, make sure that the tabs are in the full "UP" position by holding the control in the bow up position for ten (10) seconds.

Always establish the intended heading and cruise speed before attempting to adjust the hull attitude with the trim tabs. After stabilizing speed and direction, move the trim tabs to achieve a level side to side running attitude being careful not to over trim.

After depressing a trim tab switch, always wait a few seconds for the change in the trim plane to take effect. Avoid depressing the switch while

awaiting the trim plane reaction. By the time the effect is noticeable the trim tab plane will have moved too far and thus the boat will be in an overcompensated position.

When running at a speed that will result in the boat falling off plane, lowering the tabs slightly bow down will improve the running angle and operating efficiency. Too much bow down tabs can reduce operating efficiency and cause substantial steering and handling difficulties.

Be extremely careful when operating in a following sea. The effect of trim tabs is amplified under such conditions. Steering and handling difficulties can result from improper trim tab usage, particularly in a following sea. Always raise the tabs to the full bow up position in these conditions.

When running at high speeds be sure that the tabs are in the full "UP" position. Only enough trim plane action should be used to compensate

for any listing. Trim tabs are extremely sensitive at high speeds. Adjust for this and be prepared to slow down if difficulties arise.

When running into a chop, a slight bow down attitude will improve the ride. Be careful not to over trim. Handling difficulties may result.



4.9 Control Systems Maintenance

Control Maintenance

Periodic inspection of the control systems and all connections should be made. Signs of rust, corrosion, wear or other deterioration should immediately be serviced. Generally, periodic lubrication of all moving parts and connections with a light waterproof grease is in order.

Lubrication should be performed as often as necessary to keep the system operating smoothly.

Control system adjustments may become necessary. If adjustments become necessary, see your Everglades dealer.

 **WARNING** 

DO NOT ATTEMPT CONTROL ADJUSTMENTS UNLESS YOU ARE FAMILIAR WITH SERVICING CONTROL SYSTEM PROCEDURES. CONTROL MISADJUSTMENT CAN CAUSE LOSS OF CONTROL AND SEVERE ENGINE OR LOWER UNIT DAMAGE.

Hydraulic Steering System Maintenance

A periodic inspection of all steering hoses, linkage and helm assemblies should be made. Signs of corrosion, cracking, loosening of fasteners, excessive wear or deterioration should be corrected immediately.

The fluid level for the hydraulic steering should be checked frequently and maintained at the proper level. For hydraulic steering without power assist, the fluid level at the vent/fill plug at the helm should be maintained at no less than 1/2" below the bottom of the filler cap threads.

The fluid level for power assist hydraulic steering should be maintained at no less than 1/2" below the bottom of the fill plug hole on the hydraulic power assist pump reservoir located in the bilge. Only use power steering fluid recommended by the steering system manufacturer when adding fluid. Power assist pumps from different manufactur-

ers have different fluid reservoirs and filling procedures. Always refer to the power steering operation and maintenance manual for filling instructions and fluid specifications.



Generally, periodic lubrication of all moving parts and connections with a light waterproof grease is in order. Check the hydraulic hoses and fittings for chaffing, rub marks and leaks. Replace if necessary. Failure to do so could lead to steering system failure that would result in loss of control. When new or after repairs, hydraulic steering systems may need to have all air purged from the system. Only use hydraulic steering fluid recommended by the steering system manufacturer. Difficult steering and premature seal failure can result if the wrong fluid is used in the steering system. Review the information provided by the steering system manufacturer for proper specifications and details on system service and maintenance.

Electronic Steering and Control Systems Maintenance

Electronic steering and control systems are supplied by the engine or control system manufacturer. The systems have maintenance requirements that are specific to the engines and control options installed in your boat.

You should refer to the engine and controls systems owner's manuals for information and maintenance on the control and steering system installed in your boat. Their recommendations should be followed exactly.

The engine controls and steering systems are fully electronic and activated by micro processors and controlling software in each engine controller. If adjustment becomes necessary do not attempt to address the problem yourself. You should contact your Everglades or outboard engine dealer for assistance.

 **WARNING** 

IMPROPERLY ADJUSTED ELECTRONIC ENGINE CONTROLS CAN CAUSE LOSS OF CONTROL AND SEVERE ENGINE DAMAGE. IF YOUR CONTROLS ARE NOT OPERATING PROPERLY, DO NOT ATTEMPT CONTROL SYSTEM ADJUSTMENTS YOURSELF. CONTACT YOUR EVERGLADES OR ENGINE DEALER FOR ASSISTANCE AND DO NOT USE THE BOAT UNTIL THE SITUATION IS CORRECTED.

Engine Lubrication

Refer to the engine owner's manual for maintenance and lubrication instructions for the outboard engine.

Trim Tab Maintenance

The trim tab actuators are electric and require no routine maintenance except to periodically inspect the tab actuators for corrosion or marine growth and test the system to ensure that it is operating properly.

Marine growth can interfere with the proper operation of the trim tab planes and actuators. To reduce problems due to marine growth, always return the trim tabs to the full "UP" position after operating the boat and periodically inspect and clean marine growth from the actuators and planes. If your boat is equipped with the optional LED trim indicator switch, the switch is wired so the trim tabs automatically retract to the "full-up" position when the ignition switch is turned off.

If the boat is kept in the water, the trim tabs must be equipped with a zinc anode to prevent galvanic corrosion. Galvanic corrosion is the corrosion process occurring when different metals are submerged in an electrolyte. Seawater is an electrolyte and submerged metal components must be properly protected. The anodes will need to be changed when they are 75% of their original size. Refer to the Routine Maintenance chapter of this manual for information on maintaining zinc anodes.

To discourage any marine growth on tab or actuator, antifouling paint can be applied. When applying paint to the actuator, make sure it is fully retracted. Do not paint the stainless ram above the area that is exposed when retracted. The bottom paint will damage the O-ring seals when the ram is retracted and allow seawater to enter the actuator motor. Contact your dealer or the trim tab manufacturer for information regarding the correct bottom paint for the trim tabs.

Refer to the trim tab owner's manual for additional maintenance information, specifications, troubleshooting and operating instructions.



Typical Trim Tab Cylinder & Plane



Zinc Anode Installed on Trim Tab Plane

NOTES

FUEL SYSTEM

5.1 General

The gasoline fuel system used in Everglades boats sold in the United States is designed to meet or exceed the emission control standards of the Environmental Protection Agency (EPA) and the requirements of the U.S. Coast Guard, the Boating Industry Association and the American Boat and Yacht Council in effect at the time of manufacture.

All gasoline fuel systems have been factory inspected and pressure tested in accordance with regulations in effect at the time of manufacture. This inspection assures that the system is air tight, leak proof and safe. It is the responsibility of the purchaser to maintain it in that condition. Make frequent inspections to assure that no deterioration or loosening of connections is resulting from vibration.

! **DANGER** !

DO NOT LET THE ODOR OF GASOLINE GO UNCHECKED. ANY ODOR OF GASOLINE MUST BE IMMEDIATELY INVESTIGATED AND STEPS TAKEN TO PROTECT THE BOAT AND ITS OCCUPANTS UNTIL THE PROBLEM IS CORRECTED. IF THE ODOR OF GASOLINE IS NOTED, SHUT OFF ALL ENGINES AND ELECTRICAL EQUIPMENT. INVESTIGATE AND CORRECT THE SITUATION IMMEDIATELY. HAVE ALL PASSENGERS PUT ON PERSONAL FLOTATION DEVICES AND KEEP A FIRE EXTINGUISHER READY UNTIL THE SITUATION IS RESOLVED.

Fuel Withdrawal Tube

The fuel withdrawal tube is positioned in the fuel tank to achieve optimum fuel usage, fuel line routing, etc. At certain speeds and hull trim angles, the fuel supply at the withdrawal tank location can increase or decrease accordingly. Be extremely careful when attempting to operate the boat when low on fuel. Though some fuel may be in the tank, the relative trim angle of the boat may cause the fuel to flow away from the withdrawal tube.

Fuel Gauge

Indicates the amount of fuel in the tank. Due to the mechanical nature of the fuel sender, variations in readings during various speeds of operation may occur. This system is merely a relative indication of the available fuel supply and not a calibrated instrument.



Fuel Fill

Fuel Fill

The fuel tank is vented through the fill fitting and cap. The system is equipped with a "keyless" fuel cap located on the port side gunnel that is marked with a "FUEL PUMP" insignia. The fuel fill cap is designed to seal out water and allow the fuel tank to vent to the atmosphere when the cap is closed.

The fuel fill is opened by pressing the release button on the side of the cap. After fueling, make sure to close and latch the cap. Be sure to use the proper type and grade of fuel. Refer to the engine owner's manual for additional information.

Fuel Tank Vent

Your boat is equipped with a fuel tank vent system incorporated into the fuel fill. The fuel fill cap is designed to seal out water and allow the fuel tank to vent to the atmosphere when the cap is closed. While the tank is being filled, air displaced by the fuel escapes through the vent and fuel fill. When the tank is full, special valves incorporated in the vent and fill hoses close and activate the automatic shutoff valve on the marina fuel pump nozzle to prevent the tank from being overfilled and/or fuel from being ejected from the fuel fill/vent fitting. You should never attempt to "top off" the tank after the pump shutoff has activated.



Typical Yamaha Fuel Filter & Primer Bulb

The shutoff valves will not allow additional fuel to be added after they close and could be damaged by attempts to force additional fuel into the tank.

After fueling, close and latch the fill cap. Then wash spilled fuel from the areas around the fuel fill if necessary. Residual fuel left on the deck and hull sides can be dangerous and will yellow the fiberglass gelcoat or damage the striping.

5.2 Outboard Fuel System

The fuel system has one fuel tank located in the center of the bilge below the cockpit sole. The Fuel withdrawal line is equipped with an anti-siphon valve where the line attaches to the fuel tank. This valve prevents gasoline from siphoning out of the fuel tank should a line rupture.

The engine fuel filter is installed in the aft systems compartment bilge. It is the water separator type and should be serviced frequently to assure an adequate supply of clean, dry fuel to the engine.

It is recommended that the filter be inspected periodically and the element changed as needed. A valve located near the fuel withdrawal tube provides a means to turn off the fuel supply while servicing the fuel filter or any fuel system component.

There is a primer bulb in the fuel line located near the fuel filter that is used to prime the fuel system after service or as required. See Fuel System Maintenance and the engine owner's manual for additional information on the fuel filter and the outboard engine fuel system.

Notice:

The procedure to prime the fuel system on outboard engines is specific to the type and model of engine on your boat. You should refer to engine manufacturer owner's manual for the priming procedure for your engine.





CAUTION





DO NOT REMOVE THE ANTI-SIPHON VALVES FROM THE SYSTEM. SHOULD THE VALVE BECOME CLOGGED, CLEAN AND REINSTALL OR REPLACE.



5.3 Fueling Instructions

 **WARNING** 

FUEL IS VERY FLAMMABLE. BE CAREFUL WHEN FILLING THE FUEL TANK. NO SMOKING. NEVER FILL THE TANK WHILE THE ENGINE IS RUNNING. FILL THE FUEL TANK IN AN OPEN AREA. DO NOT FILL THE TANK NEAR OPEN FLAMES.

 **CAUTION** 

TO PREVENT DAMAGE TO THE FUEL SYSTEM, USE ONLY A GOOD GRADE OF GASOLINE FOR GASOLINE ENGINES. DO NOT USE FUEL THAT CONTAINS HARSH ADDITIVES OR IS AN ALCOHOL BLEND OF HIGHER CONCENTRATION THAN RECOMMENDED BY THE ENGINE MANUFACTURER. ANY DAMAGE DONE TO THE FUEL SYSTEM THAT IS THE RESULT OF USE OF AN ALCOHOL BLEND IS NOT COVERED BY THE EVERGLADES WARRANTY. REFER TO THE ENGINE MANUFACTURER OWNER'S MANUAL REGARDING FUEL REQUIREMENTS FOR YOUR ENGINE.



 **WARNING** 

DO NOT CONFUSE THE FUEL FILL DECK PLATE WITH THE WATER OR WASTE PUMP OUT DECK PLATE. THESE PLATES ARE LABELED ACCORDINGLY. IF FUEL IS ACCIDENTALLY PUMPED INTO THE WATER OR WASTE TANK, DO NOT ATTEMPT TO PUMP IT OUT YOURSELF. WATER AND WASTE PUMPS ARE NOT DESIGNED TO PUMP FUEL AND A FIRE OR EXPLOSION COULD RESULT. CONTACT YOUR DEALER OR THE EVERGLADES CUSTOMER SERVICE DEPARTMENT FOR ASSISTANCE IN HAVING THE FUEL PROFESSIONALLY REMOVED.

Preparing the Boat for Fueling

Use the following procedure to prepare the boat for fueling at a marina fuel station:

- Make sure the boat is securely moored and all engines are off.
- Make sure all switches are in the OFF position.
- Make sure all passengers leave the boat.
- Close all doors and hatches.

 **WARNING** 

GASOLINE FUEL VAPORS THAT ACCUMULATE IN THE BILGE, AFT SYSTEMS STATION OR CABIN WHILE FUELING CAN EXPLODE!! FUEL VAPORS ARE HEAVIER THAN AIR AND CAN ACCUMULATE IF THEY ARE CARRIED BY THE WIND INTO THE BILGE OR CABIN THROUGH OPEN DOORS, HATCHES OR VENTS. ALWAYS CLOSE DOORS AND HATCHES BEFORE FUELING.

- Estimate how much fuel is needed and avoid overfilling the fuel tank.



Fueling the Boat

In order to comply with U.S. EPA emission regulations, Everglades boats are equipped with special fuel systems that reduce the flow of fuel vapors from the fuel system to the atmosphere when fueling operations are complete.

These fuel systems meet U.S. EPA emission standards and are designed to maintain a specific air space at the top of the fuel tank that provides proper tank ventilation and protection for emission control components. Special valves in the fuel tank vent and fill systems and a shutoff valve in marina fuel pump nozzles are designed to automatically stop the fuel flow when the tank is full and maintain this air space.

Notice:

When the fuel tank is full, the shutoff valve in the marina fuel pump nozzle will activate and automatically shut off the flow, indicating that the tank is filled to the maximum level. You should stop filling the tank at this point and never attempt to "top off" the tank. Attempting to "top off" the tank could damage fuel level control valves.

 **WARNING** 

STATIC ELECTRICITY GENERATED BY FLOWING FUEL CAN CAUSE A FIRE OR EXPLOSION. TO PREVENT STATIC SPARKS WHEN FILLING THE TANK, MAKE SURE THE NOZZLE IS ALWAYS IN CONTACT WITH THE FUEL FILL OPENING

To fill the fuel tank, follow this procedure:

- The fuel cap is hinged and does not require a key. Press the release button on the side of the cap and swing it open for fueling.
- Make sure the nozzle is equipped with an automatic shutoff valve. Then put the nozzle in the fuel fill opening and make sure it stays in contact with the fuel fill fitting during the entire fueling operation.
- Fill the tank until the shutoff valve in the pump nozzle clicks and automatically stops the fuel flow.
- Remove the nozzle and close the cap.



WARNING



FUEL TANK CONTENTS CAN BE UNDER PRESSURE. TO AVOID SERIOUS INJURY OR DEATH FROM FIRE OR EXPLOSION, OPEN FUEL CAP SLOWLY IN A WELL VENTILATED AREA. NO SMOKING OR OPEN FLAMES.



WARNING



SPILLED FUEL CAN CAUSE A FIRE OR AN EXPLOSION. MAKE SURE YOU DO NOT SPILL ANY FUEL. IF A SMALL AMOUNT OF FUEL IS SPILLED ON THE FIBERGLASS, USE A CLOTH TO REMOVE THE FUEL AND PROPERLY DISPOSE OF THE CONTAMINATED CLOTH. IF FUEL IS SPILLED ON THE WATER, EXERCISE EXTREME CAUTION. FUEL FLOATS ON THE SURFACE OF THE WATER AND CAN IGNITE. IF FUEL IS SPILLED INTO THE WATER, IMMEDIATELY EVACUATE THE AREA AND NOTIFY THE MARINA AND THE PROPER OFFICIALS.

Preparing the Boat For Operation

Use the following procedure to prepare the boat for operation when fueling operations are complete:

- Open all hatches, windows and doors.
- Check the fuel compartment and below the deck for fuel odors. If you smell fuel, do not start the engines.

5.4 Fuel System Maintenance

Periodically inspect all primer bulbs, connections, clamps and hoses for leakage, damage or deterioration. Replace as necessary. Spray the valve, tank fuel gauge sender and ground connections with a metal protector.

Access to the fuel tank sending unit and fuel valves is located below a removable hatch located in the helm seat base. Access to fuel tank fill and vent hose connections is located under an access plate under the helm anti-fatigue mat.

Frequently inspect and lubricate the fuel fill cap seal with Teflon or silicone grease. The seal prevents water from entering the fuel system through the fuel fill cap and it should be immediately replaced if there is any sign of damage or deterioration.



Typical Yamaha Fuel Filter In Aft Systems Compartment



Typical Fuel Withdrawal Valves & Tank Sending Unit

Fuel System



Contaminated fuel may cause serious damage to your engines. Fuel filters must be checked for corrosion and deterioration frequently. Fuel filters must be changed at least once a season or more frequently depending on the type of engine and the quality of the fuel. Refer to the engine or fuel filter manufacturer's instructions for information on servicing and replacing the fuel filter.



The age of gasoline can effect engine performance. Chemical changes occur as the gasoline ages that can cause deposits and varnish in the fuel system as well as reduce the octane rating of the fuel. Severely degraded fuel can damage the engine and boat fuel tank and lines. Therefore, if your boat is not being run enough to require at least one full tank of fresh fuel a month, a fuel stabilizer should be added to the gasoline to protect the fuel from degradation. Your dealer or the engine manufacturer can provide additional information on fuel degradation and fuel stabilizers recommended for your engine.



In many states, most gasoline is blended with ethanol alcohol. Ethanol is a strong solvent and can absorb water during periods of storage. You should refer to the engine operating manual for information regarding alcohol blended fuels and how it affects the operation of your marine engine.



Typical Fuel Fill & Vent Hose Connections

	WARNING	
<p>DO NOT DRAIN ANY FUEL INTO THE BILGE WHEN SERVICING THE FUEL SYSTEM. THIS COULD LEAD TO A FIRE OR EXPLOSION.</p> <p>AFTER THE FILTER ELEMENTS HAVE BEEN CHANGED, PRIME THE FUEL SYSTEM AND CHECK ALL FITTINGS FOR LEAKS BEFORE AND AFTER STARTING THE ENGINE.</p> <p>BEFORE STARTING THE ENGINE, ALWAYS OPEN ALL HATCHES, WINDOWS AND DOORS TO COMPLETELY VENTILATE THE BOAT AFTER SERVICING THE FUEL SYSTEM.</p>		

	WARNING	
<p>TO REDUCE THE POSSIBILITY OF A FIRE OR EXPLOSION, MAKE SURE ALL ELECTRICAL SWITCHES ARE IN THE OFF POSITION BEFORE SERVICING THE FUEL SYSTEM.</p>		

	DANGER	
<p>AVOID SERIOUS INJURY OR DEATH FROM FIRE OR EXPLOSION RESULTING FROM LEAKING FUEL, INSPECT SYSTEM FOR LEAKS AT LEAST ONCE A YEAR.</p>		

NOTES

ELECTRICAL SYSTEM

6.1 General

Your boat is equipped with a 12 volt DC electrical system and a 120 volt AC battery charging system. The AC system draws current from a shore power outlet at dockside. The DC system draws current from onboard batteries.

Your boat and engine charging system is designed for 12 volt, lead acid wet cell or AGM marine batteries. They will require similar maintenance as those found in automobiles.

All wires in the electrical systems are color coded to make identifying circuits easier. Wiring schematics have been included with this manual to aid in following an individual circuit of the boat.



6.2 12 Volt System Overview

The 12 volt system is a fairly standard marine system. There are two batteries, one battery for the engine and one for the house and electronics.

The batteries are in a compartment behind a removable hatch in the head compartment. They are controlled by a battery selector switch.

Most 12 volt power is distributed to the 12 volt accessories through individual circuit breakers and fuses located in panels near the batteries, in the head compartment and below the helm. All circuit breakers or fuses are labeled by the name of the circuit they protect. Main circuit breakers near the batteries protect the primary circuits for the windshield, windlass, amplifier and power steering system. Fuses in a panel near the main breakers protect continuous power circuits for the automatic float switches for bilge pumps, high water alarm. There is also a fuse for the windlass switch in the anchor locker. Circuit breakers in the battery switch panel protect the DC main, stereo memory and electronics. Most 12 volt accessories are operated directly by switches in the helm switch panel. Most accessory circuits activated by the helm switches are protected by circuit breakers built into each switch.

Main breakers or fuses located on each engine protect the ignition systems and gauge panel display. Yamaha engine electrical circuits are protected by fuses located in a fuse panel on the side of the engine. The fuse panel is equipped with a spare fuse for each circuit. Always replace fuses used with the fuse specified by Yamaha or your engine manufacturer. Refer to the engine owner's manual for more information on the fuses, fuse panels or circuit breakers on your engines.

	CAUTION	
PROPER FUSE OR BREAKER PROTECTION MUST BE PROVIDED FOR ALL 12 VOLT EQUIPMENT ADDED. DO NOT OVERLOAD THE ACCESSORY CIRCUIT BREAKERS OR OTHER CIRCUITRY THROUGH ADDITIONAL 12 VOLT EQUIPMENT.		

6.3 Batteries & Battery Switches

The DC electrical system on your boat is designed for wet cell marine batteries or absorbed glass mat (AGM) batteries. Do not attempt to use gel cell or other non wet cell batteries. The engine charging system is not designed to recharge these batteries which could cause unusually short battery life, engine starting problems and damage to the DC charging system. You should also not mix the size or brand of wet cell batteries. Always consult your Everglades dealer before changing the type of batteries in your boat.

Your boat has provision for two batteries. These batteries should be of the size and capacity recommended by the manufacturer of your engine. See the engine owner's manual. These specifications should be considered to be the minimum size battery required. Consider increasing the capacity of the batteries if you will be trolling, drift fishing or have extensive electronics onboard. Larger batteries will give you additional capacity to operate the baitwell, washdown and electronics at low speed when the charging system output from the engine is minimal.



Battery Switches, Fuse Panels & Main Circuit Breakers

The battery selector switch is located in a panel in the head compartment. The switch feeds the engine, 12 volt accessory switch panel and electronics. The battery switch is a dual circuit switch that has four positions, OFF, 1, 2 and 1 & 2 (both batteries). 12 volt power can be supplied by either battery 1 or battery 2 separately or by both batteries simultaneously. The selector switch also directs the charging current when the engine is operating.

For example: When the switch is on battery 1, the engine and 12 volt system will be supplied power by battery 1. Battery 2 will be isolated and in reserve. Battery 1 will be charged by the alternator. When the selector switch is on battery 2, the engine and 12 volt system will be supplied power by battery 2. Battery 1 will be isolated and in reserve. Battery 2 will then be charged by the alternator.

When the selector switch is on 1 & 2, the batteries are connected in parallel so the engine and

12 volt system will be supplied power by both batteries. Both batteries will be charged by the alternator. The 1 & 2 position should only be used when starting the engine, as this requires extra electrical power or when both batteries are low and need charging. Otherwise, it is recommended that the selector switch be set on battery 1 or battery 2 when the engine is operating. While in port, trolling or at anchor, the battery selector switch should be set on either the battery 1 or the battery 2 position. This will keep one battery in reserve for starting the engine. The battery switch should be turned to the OFF position when leaving the boat unattended.

Notice:

Current is supplied to the automatic float switches for the bilge pumps and high water alarm when the batteries are connected, even if the battery switch is off.

6.4 Ignition Switch Panels

Ignition Switch Panels

Ignition switch panels are unique to each engine manufacturer and the engine control options selected. Your dealer will provide you with the proper starting procedure for your boat at the time of delivery. Additional information for the ignition switch system installed in your boat is located in the engine and control system operating manuals included in your information packet.

Single Engine Yamaha Command Plus® Ignition

Some single engine Everglades boats are equipped with a Yamaha engine and Command Link or Command Link Plus® ignition key panels that offer simplicity and durability.

The ignition switch is a key activated switch, located near the helm below the steering wheel, which starts and stops the engine. The switch has OFF - ON and momentary START positions.

Starting procedure

Make sure the engine is tilted down with the shift lever in the neutral position and your hand on the control lever. Turn the ignition key to the ON position to activate the fuel pump and ignition system. Wait 5 seconds for the fuel pump to pressurize the system, then turn the key to the start position. When the engine starts, release the key and the switch will automatically go to the run position. Stop the engine by turning the key to the OFF position.

The engine ignition circuits are protected by fuses or circuit breakers located on each engine.

Helm Master EX Ignition (Optional)

The Yamaha Helm Master EX ignition system offers the latest technology and security. This is a "keyless" electronic panel which energizes the ignition system with only a Radio Frequency ID key by touching the panel with the electronic key. The panel features lights which indicate when the engine is running and a START/STOP button for the engine. For convenience and protection, engine can not be restarted while running.

Starting And Stopping Procedure

Make sure the engine is tilted down with the shift lever in the neutral position and your hand is on the control levers. Touch the panel with the electronic key fob to unlock and activate the panel. The

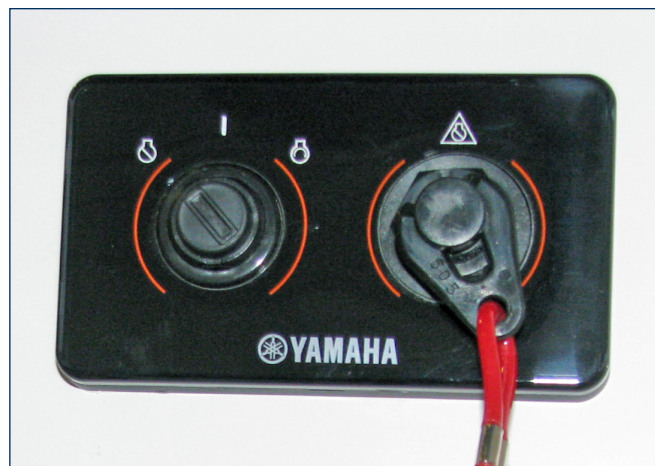

Typical Yamaha Command Link Ignition



Typical Yamaha Helm Master EX Ignition Panel

panel will beep twice to indicate it is unlocked and the buttons are active. Once the panel is activated, press the POWER button, then the START/STOP button to start the engine. It is not necessary to hold the button, just press it once and release it. The computer will automatically check all engine systems and start the engine. Stop the engine by pressing the START/STOP button again. Touch the panel with the electronic key to deactivate and lock the panel. The panel will beep once to indicate that it is locked and the engine and START/STOP buttons are deactivated.



Helm Accessory Switch Panels

6.5 12 volt Accessory Switch Panels

The accessory switch panels at the helm are equipped with push button switches that are labeled for the accessories they control. An LED light built into each switch indicates that the circuit is activated.

The switches have built in circuit protection. If a switch senses an overload, it will turn off to protect the circuit and the LED light will change from blue to red. Press and hold the switch to reset it. If it trips again, find and correct the problem before attempting to activate the accessory again.

The following is a description of the accessories controlled by the main accessory switch panel:

Horn

A momentary switch that activates the boat horn.

Nav/Anc

Press the switch once to activate the navigation lights. Press the switch again for anchor light only. Press the switch again to turn the lights off.

Bilge 1

Press the switch once to manually activate the aft bilge pump located in the stern bilge near the transom. Press the switch again to turn the pump off. The pump moves water out through a fitting in the



Helm Accessory Switch with Circuit Breaker Tripped

hull. The pump is also activated by an automatic float switch that is activated whenever the batteries are connected. This pump will run as needed whenever the water in the bilge accumulates high enough to raise the float switch to the ON position and turn off when the water is removed.

Bilge 2

Press the switch once to manually activate the aft bilge pump located in the stern bilge just behind the aft bilge pump. Press the switch again to turn the pump off. The pump moves water out through a fitting in the hull. The pump is also activated by an automatic float switch that is activated whenever the batteries are connected. This pump is

the emergency pump. It will automatically run as needed whenever the water in the bilge accumulates above the normal operating range of bilge pump 1 and high enough to raise the float switch to the ON position. It will turn off when the water is removed.

Notice:

The bilge pumps will start automatically when there is sufficient water in the bilge to activate the float switch. Each float switch is protected by a fuse located in the panel near the main circuit breakers and is always supplied current when the batteries are connected.

Alarm

A red LED light illuminates and an alarm sounds if the bilge water level rises above the normal operating range of the bilge pump 1 automatic switch and activates emergency pump 2. The alarm is connected to the same automatic float switch that activates bilge pump 2. It remains activated when the battery switches are in the OFF position and the batteries are connected. It is protected by the same fuse that protects the bilge pump 2 automatic switch circuit.

Port Baitwell - Pump (Optional)

Press the switch once to activate the port baitwell pump. Press the switch again to turn the pump off.

Port Baitwell - Light (Optional)

Press the switch once to activate the light in the port baitwell. Press the switch again to turn the light off.

Starboard Baitwell - Pump

Press the switch once to activate the starboard baitwell pump. Press the switch again to turn the pump off.

Starboard Baitwell - Light

Press the switch once to activate the light in the starboard baitwell. Press the switch again to turn the light off.

Fresh Water

Press the switch once to activate the fresh water pump that supplies the fresh water washdown hose connector in the cockpit and the windshield washer. Press the switch again to turn the pump off. The pump is the pressure demand type. A pressure switch automatically controls the water pump when the system is activated and properly primed.

Raw Water

Press the switch once to activate the raw water washdown pump that supplies the raw washdown hose connector in the cockpit. Press the switch again to turn the pump off. The pump is the pressure demand type. A pressure switch automatically controls the water pump when the system is activated and properly primed.

Windlass UP/Down Switches

Momentary switches that control the windlass which is mounted in the windlass compartment above the rope locker. Press and hold the UP switch to pull the anchor line in. Press and hold the DOWN switch to pay the anchor line out. The switches automatically return to the OFF position when released.

Windshield - Wiper

Press the switch once to activate the windshield wiper. Press the switch again to turn the wiper off.

Windshield - Washer

Press and hold the switch to activate the solenoid that sprays water on the windshield washer from the fresh water system. Release the switch to deactivate the washer.

Notice:

The fresh water system must be activated for the windshield washer to work.

Windshield UP/DOWN

Momentary switches that activate the hydraulic rams that raise and lower the windshield to provide ventilation for the helm area and/or improve visibility. Press and hold the UP switch to raise the windshield. Press and hold the DOWN switch to lower the windshield. The switches automatically return to the OFF position when released.

Fishbox

Press the switch once to activate the pump that drains the forward fishbox. Press the switch again to turn the pump off. To avoid damage to the pump, always monitor the water level as the pump drains the fishbox and turn it off immediately when draining is complete.

Spreader Lights - Fwd

Press the switch once to activate the overhead light at the front of the hardtop that illuminates the forward cockpit. Press the switch again to turn the light off.

Spreader Lights - Aft

Press the switch once to activate the overhead light at the rear of the hardtop that illuminates the aft cockpit. Press the switch again to turn the light off.

Courtesy Lights

Press the switch once to activate the blue LED lights that illuminate the cockpit area. Press the switch again to change the blue lights to white. Press the switch again to turn the light off.

If your boat is equipped with the optional Full Color Spectrum LED light system, the switch can be pressed multiple times to change courtesy light color and intensity.

Helm Lights

Press the switch once to activate the red LED lights in the hardtop liner. Press the switch again to change the red lights to white. Press the switch again to turn the lights off.

Red lights have less effect on night vision and should be selected if you need to illuminate the helm area while navigating at night.

Underwater Lights (Optional)

Press the switch once to activate the blue LED underwater lights in the stern below the water line. Press the switch again to change the blue lights to white. Press the switch again to turn the lights off.

If your boat is equipped with the optional Full Color Spectrum LED light system, the switch can be pressed multiple times to change courtesy light color and intensity.

If the underwater lights option is not installed, this switch is reserved for additional 12 volt accessories.

Light Bar (Optional)

Press the switch once to activate the light bar that illuminates the area in front of the boat for better visibility while docking at night. Press the switch again to turn the light off.

If the light bar option is not installed, this switch is reserved for additional 12 volt accessories.

USB Connection

Located on the starboard side of the helm. Provide an input for MP3 players and USB drives to connect to the boat stereo system. The USB connections will charge cell phones and other portable electronics that are charged by a USB cord.



Typical Trim Tab Switches



Typical Power Tilt & Trim Switch

Console Power Port

A 12 volt accessory plug at the helm is an available option.

Additional DC Switches and Panels

Trim Tab Switch

Located in the helm. This switch controls the trim tab planes located on the transom of the boat. It is protected by a fuse located in the fuse panel below the helm. Refer to the Helm Control Systems chapter for detailed information on the operation of the trim tab controls.

Engine Trim and Tilt Switch

Located in the helm. This switch is typically installed in the engine throttle and shift control handle. It controls the trimming and tilting of the engine. Refer to the Helm Control Systems chapter and the engine owner's manual for information regarding the proper use of the tilt and trim switch.



Typical Power Port



Anchor Locker Windlass Switch

Forward Windlass Switch

The switch is a three-position momentary switch located in the windlass compartment near the windlass. The center position is OFF. Moving the switch in one direction will pay the anchor line out. Moving the switch in the opposite direction will pull the anchor line in. Release the switch to stop the windlass.

Power Ports (Optional)

The optional 12 volt power ports are located below the gunnel on each side of the cockpit. The power ports provide a 12 volt DC power connection for down riggers or electric reels. Each power port requires a special plug to be installed on the power cord of the accessory. Additional plugs can be ordered through your dealer.

The ports are protected by individual fuses located a fuse panel below the helm.



Helm Accessory Switch with Circuit Breaker Tripped

6.7 DC Circuit Breakers

General

Power is distributed to some 12 volt accessories through individual “push to reset” circuit breakers located in the battery switch panel. A Main breaker protects the helm switch panel from an overload. Other circuit breakers built into the helm switches protect the accessory circuits controlled by those switches.

Heavy duty circuit breakers near the batteries protect the main circuits for the windlass, power steering, stereo amplifier, and the windshield hydraulic pump.

Some 12 volt accessories are operated directly by the circuit breaker or fuse. Switches fed by the circuit breakers or fuses activate other accessories.

Battery Switch Panel Circuit Breakers

These “push to reset” circuit breakers are labeled for the accessory circuit they protect. Circuit breakers labeled AUX OR SPARE are reserved for additional accessories not usually installed by the factory.

If an accessory breaker trips, the reset button pops out and can be felt through the silicone protective cover. Press the button to reset the tripped breaker. If the breaker trips again, find and correct the problem before resetting the breaker.

Helm Accessory Switch Circuit Breakers

The switches in the helm accessory switch panel have built-in circuit breakers that protect the ac-



Battery Switch Panel Circuit Breakers

cessory circuits. If a switch senses an overload, it will trip the breaker and turn off to protect the circuit. The LED light will change from blue to red to indicate the breaker has tripped. Press and hold the switch to reset it. If it trips again, find and correct the problem before attempting to activate the accessory again.



CAUTION



PROPER FUSE OR BREAKER PROTECTION MUST BE PROVIDED FOR ALL 12 VOLT EQUIPMENT ADDED. DO NOT OVERLOAD THE ACCESSORY CIRCUIT BREAKERS OR OTHER CIRCUITRY THROUGH ADDITIONAL 12 VOLT EQUIPMENT.

Heavy Duty Circuit Breakers

DC Power is distributed to the windlass, power steering, stereo amplifier, windshield hydraulic pump and other main circuits through heavy duty circuit breakers located in the battery compartment near the battery charger. These main circuits are deactivated when the House battery switch is off.

If a heavy duty circuit breaker is tripped by an overload, a yellow lever will be exposed near the center of the breaker. Reset the breaker by raising the lever until it locks in the horizontal position. A test button near the reset lever can be pressed to test the breaker to ensure it is operating properly.

Notice:

If a heavy duty circuit breaker trips, always make sure the problem that caused the breaker to trip is found and corrected before resetting the breaker.

6.8 Engine Control Systems Circuit Protection

Power assist steering and Yamaha or Mercury engines with electronic steering and control systems are equipped with heavy duty circuit breakers or fuses for each steering pump and the controls that protect those components from an overload. Other heavy duty circuit breakers or fuses protect the charging circuit for the engine.

Circuit protection will vary with each engine installation as controls and steering systems may be different. Refer to the engine and steering system owner's manuals for information on circuit protection and amperage requirements for the engine and control systems on your boat.



Heavy Duty Circuit Breakers

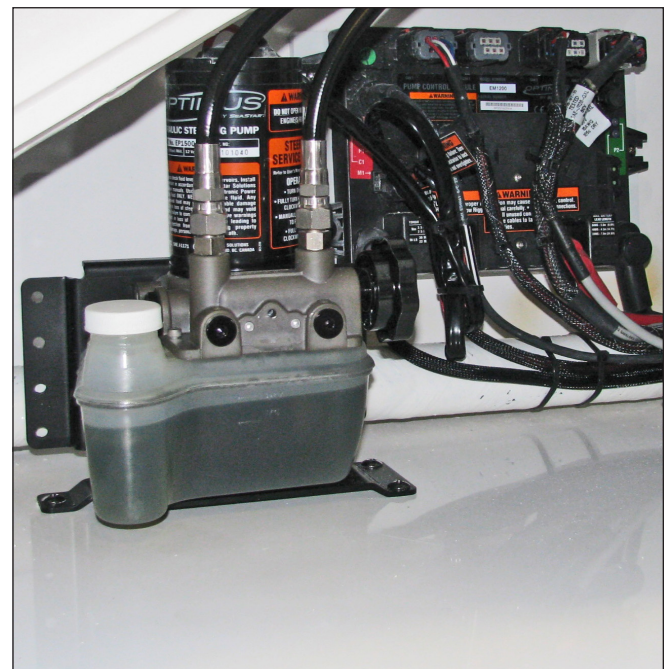

Typical Yamaha Electronic Steering Pump & Control Panel

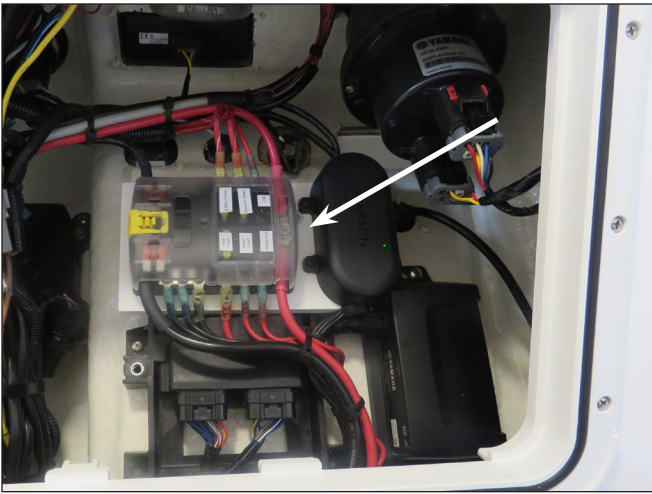

Accessory Fuse Panel Below the Helm

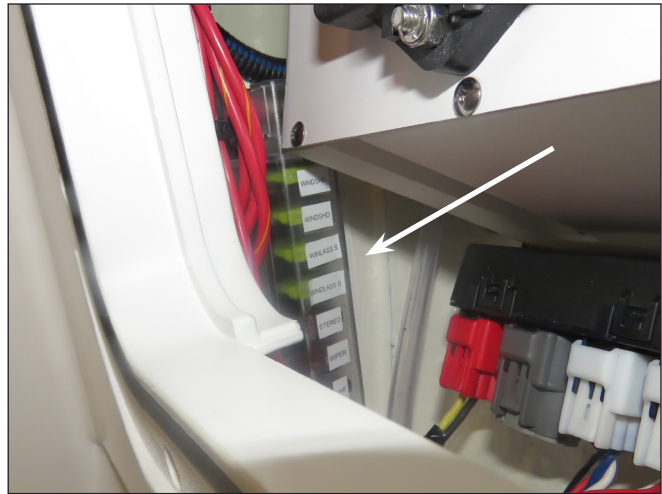

Accessory Fuse Panel Below the Helm

6.9 Accessory Fuse Panels

Fuses in panels located below the helm and in the battery compartment near the battery charger protect the circuits for other accessories not protected by the battery switch circuit breakers or helm switch circuit protection. The fuse panels are supplied power by the battery switch or are continuous power, depending on the circuit they protect.

Notice:

The bilge pump and high water alarm fuses protect continuous power circuits for the automatic switches. Continuous power circuits are supplied electrical power whenever the batteries are connected. These circuits are not deactivated when the battery switches are turned off.

Each fuse is labeled by the circuit of the accessory they protect. The fuses in your boat will vary, depending on the equipment and options selected.

If a fuse blows, it must be replaced with a fuse of the same amperage as the original. The fuses are labeled and color coded. Never try to correct a problem with a 12 volt accessory by installing a larger fuse. This could cause the accessory or circuit with a problem to overheat, which could result in an electrical fire.



Electronics Fuse Panel Below the Helm



Continuous Power & Accessory Fuses Near Battery Charger

Electrical System

6.10 120 Volt AC Battery Charging System

General

The system is supplied 120 volt AC current by a power cable connected to a shore side outlet and the shore power inlet. It is wired totally separate from the 12 volt DC system and charges the engine and house batteries simultaneously when connected.

Notice:

The power cord used for the battery charger system is not equipped with lock rings on the shore side or boat connector plugs. The charger has integrated reverse polarity protection and the circuit is not equipped with a reverse polarity light.



Typical 120 Volt Shore Power Inlet Connection

⚠ DANGER ⚠

TO REDUCE THE POSSIBILITY OF AN ELECTRICAL SHOCK, IT IS IMPORTANT THAT THE AC GROUND SYSTEM IS FUNCTIONING PROPERLY AND THAT A PROPER CONNECTION EXISTS BETWEEN THE SHORE POWER CORD AND THE SHORE POWER INLET AND THE OUTLET GROUND CIRCUITS. IF THERE IS ANY DOUBT ABOUT THE INTEGRITY OF THE GROUND CIRCUIT, A QUALIFIED MARINE ELECTRICIAN SHOULD BE CONTACTED IMMEDIATELY AND THE SHORE POWER SHOULD BE DISCONNECTED UNTIL THE NECESSARY REPAIRS ARE COMPLETED.

ELECTRICAL SHOCKS FROM 120 VOLT CIRCUITS CAN CAUSE SEVERE INJURY OR DEATH. TO REDUCE THE RISK OF ELECTRICAL SHOCK IN WET WEATHER, AVOID MAKING CONTACT WITH THE SHORE CABLE OR MAKING A CONNECTION TO A LIVE SHORE OUTLET. NEVER SPRAY WATER ON ELECTRICAL CABLES WHILE WASHING DOWN DECKS.

⚠ WARNING ⚠

DO NOT ATTEMPT TO CORRECT THE WIRING YOURSELF. ELECTRIC SHOCK CAN CAUSE SEVERE INJURY OR EVEN DEATH. ALWAYS HAVE A QUALIFIED ELECTRICIAN CHECK WIRING.

KEEP CHILDREN AWAY FROM ANY ELECTRICAL CABLES OR EQUIPMENT.

⚠ WARNING ⚠

UNDETECTED FAULTS IN THE AC BATTERY CHARGING SYSTEM COULD CAUSE THE WATER AROUND THE BOAT TO BECOME ENERGIZED. THIS COULD CAUSE A SEVERE SHOCK OR EVEN DEATH TO SOMEONE IN THE WATER NEAR THE BOAT. NEVER SWIM OR ALLOW SWIMMING AROUND THE BOAT WHEN THE BATTERY CHARGING SYSTEM IS ACTIVATED BY THE SHORE POWER CONNECTION.

Shore Connection Procedure

If the dockside outlet includes a disconnect switch or circuit breaker, turn it to the OFF position. To avoid strain on the cable, make sure it has more slack than the mooring lines. Dress the cable so that it cannot be damaged by chafing between the boat and the dock. Make sure the cable does not come in contact with the water.

Open the cover on the inlet and connect the shore cable to the inlet cord plug making sure the shore cord includes a three-prong plug with a ground wire. Turn the dockside disconnect switch or circuit breaker ON and check that each battery charger is operating properly. If the battery charger is not working, turn off the shore disconnect switch/circuit breaker and remove the cable. Contact your dealer or a qualified electrician to find and correct the problem.

Disconnecting Shore Power Procedure

Turn the disconnect switch or circuit breaker on the dockside outlet to the OFF position. Disconnect the cable from the dockside outlet and replace the outlet cap. Disconnect the cable from the inlet port and close the cap. Store cable.

Battery Charger

The 2 bank battery charger is mounted near the batteries in the head compartment. AC electrical current is supplied directly to the battery charger by the shore power cable. The charger automatically charges and maintains the engine and house batteries simultaneously when activated. It is equipped with LED lights to indicate the state of charge for each battery.

The charge to the engine battery can be monitored by using the volt meter in the engine gauge cluster or the LED lights on the charger. To monitor the engine battery with the volt meter in the engine gauge cluster, activate the charger and turn the engine battery switch on. Turn the ignition key switch to the ON position (DO NOT START THE ENGINE) and read the voltage on the volt meter.

If the batteries are in good condition and charging properly, the volt meter will indicate between 12 and 14.5 volts. If the reading is below 12 volts, then the battery is not accepting a charge or the charger is not working properly. Always turn the ignition switch off immediately after the monitoring is complete.

The wires that supply DC charging current to the batteries are protected by an internal fuse in the battery charger and external fuses or circuit breakers, one for each battery output wire, located near each battery. The external fuses protect the DC charging circuit from the batteries to the charger. The internal fuses in the charger protect the DC charging circuit from the charger to the batteries. Refer to the battery charger manual for more information.

6.11 Bonding System

Your boat is equipped with a bonding system that interconnects the underwater metal hardware and the engine to ensure that they are of the same electrical potential. Sacrificial anodes of the size and type recommended by the engine manufacturer are attached to the outboard motor. There could also be sacrificial anodes on each trim tab plane that are isolated from the boat bonding system to protect each tab plane assembly if the boat is to be kept in salt water.

Anodes deteriorate before the other metals, thereby protecting the underwater metals from galvanic corrosion or stray electrical current. Since the anodes are sacrificial, it is important to monitor



Typical Battery Charger

them and replace the anodes when they have deteriorated to 50 - 75% of their original size.

The bonding system is connected to the engine and battery DC ground. If your boat is equipped with the optional battery charger, the earth ground wire for the AC electrical system is also connected to the bonding system. It provides a path to the safety earth ground in the event of a fault in the shore earth ground connection.



6.12 Electrical System Maintenance

DC Electrical System Maintenance

At least once a year, spray all exposed electrical components behind the helm, in the stern bilge area and in the plugs with a protector. Removable light fixture bulbs should be removed and the metal contact areas coated with a non-water soluble lubricant like Teflon or Silicone grease. The sockets should be sprayed with a protector. Care must be taken not to get any oil or grease on the glass portion of the bulbs as this will cause the bulb to overheat and burn out.

Notice:

Most LED light fixtures are sealed and not serviceable.

 **CAUTION** 

WHEN REPLACING LIGHT BULBS IN MARINE LIGHT FIXTURES, ALWAYS USE A BULB WITH THE SAME RATING AS THE ORIGINAL. USING A DIFFERENT BULB COULD CAUSE THE FIXTURE TO OVERHEAT AND MELT OR SHORT CIRCUIT.



Check all below deck wiring to be sure it is properly supported, that the insulation is sound and that there are no loose or corroded terminals. Corroded terminals should be thoroughly cleaned with sandpaper or replaced, tightened securely and sprayed with a metal and electrical protector. Inspect all engine wiring.

Your boat is equipped with batteries that were supplied by your dealer. Some batteries are sealed, AGM or maintenance free wet cell batteries that do not require inspection or service. However, if your boat is equipped with standard wet cell type batteries that are not maintenance free, they will require the following inspection and service.

Check the electrolyte level in the batteries regularly and add distilled water as necessary. If the batteries are frequently charged by an automatic battery charger, the electrolyte level will have to be checked more often. The correct fluid level in the cells is approximately 1/4 to 1/2 inch above the plates. If fluid is needed, fill to the proper level with distilled water. Do not over fill and only use distilled water.

Keep all battery tops clean and dry. Dirt and water can conduct electricity from one post to the other causing the battery to discharge.

The battery posts on all batteries should be kept free of corrosion. Remove the cables and clean the posts and cable clamps with a battery post cleaner or sandpaper as required. Coating the battery posts and cable clamps with Teflon or Silicone grease will protect them and reduce corrosion. Battery cables, both hot and ground, must be replaced when they show signs of corrosion or fraying. Deteriorated cables cause a considerable voltage loss when high currents are drawn, as for starting the engine.

 **WARNING** 



NEVER USE AN OPEN FLAME IN THE BATTERY STORAGE AREA. AVOID STRIKING SPARKS NEAR THE BATTERY. A BATTERY CAN EXPLODE IF A FLAME OR SPARK IGNITES THE HYDROGEN GAS THE BATTERY EMITS WHILE BEING CHARGED.

AC Electrical System Maintenance



Periodically inspect all wiring for nicks, chafing, brittleness, improper support, etc. Examine the shore power cord closely for cracks in the insulation and corrosion in electrical connectors. Spraying receptacles and electrical connections with an electrical contact cleaner or a metal and electrical protector will reduce corrosion and improve electrical continuity.

Inspect all wiring for proper support, sound insulation and tight terminals.

The entire AC circuitry, especially the shore power cord, should be seasonally tested for proper continuity by an experienced electrician. This will detect any shorts, open wires or ground faults.

 **WARNING** 

CORROSION ALLOWED TO BUILD ON THE ELECTRICAL CONNECTORS CAN CAUSE A POOR CONNECTION RESULTING IN SHORTS, GROUND FAULTS OR POOR GROUND CONNECTIONS. ELECTRICAL CONNECTORS SHOULD BE CHECKED AT LEAST ANNUALLY AND CLEANED AS REQUIRED. DO NOT ALLOW CORROSION TO BUILD ON CONNECTIONS.

 **WARNING** 



THE AC AND DC ELECTRICAL SYSTEMS ALWAYS SHOULD BE DISCONNECTED FROM THE POWER SOURCE BEFORE INSPECTING OR SERVICING THE SYSTEM. NEVER SERVICE ANY COMPONENT OF AN ELECTRICAL SYSTEM WHILE IT IS ENERGIZED.



NOTES

FRESH WATER SYSTEM

7.1 General

The fresh water system consists of a potable water tank, distribution lines and a distribution pump. The pump is equipped with an automatic pressure switch and is located near the water tank in the aft systems compartment. The tank is located in the bilge.

	CAUTION	
DO NOT FILL SYSTEM WITH ANYTHING OTHER THAN WATER. SHOULD THE SYSTEM BECOME CONTAMINATED WITH FUEL OR OTHER TOXIC FLUIDS, COMPONENT REPLACEMENT MAY BE NECESSARY.		

	WARNING	
DO NOT CONFUSE FUEL FILL DECK PLATE WITH THE WATER OR WASTE FILL DECK PLATES. THESE PLATES ALSO ARE LABELED ACCORDINGLY. IF FUEL IS ACCIDENTALLY PUMPED INTO THE WATER OR WASTE TANK, DO NOT ATTEMPT TO PUMP IT OUT YOURSELF. WATER AND WASTE PUMPS ARE NOT DESIGNED TO PUMP FUEL AND A FIRE OR EXPLOSION COULD RESULT. CONTACT YOUR DEALER OR THE EVERGLADES CUSTOMER SERVICE DEPARTMENT FOR ASSISTANCE IN HAVING THE FUEL PROFESSIONALLY REMOVED AND COMPONENTS OF THE FRESH WATER SYSTEM REPLACED AS NECESSARY.		

7.2 Fresh Water System Operation

Fill the water supply tank slowly through the labeled deck fill fitting. After filling the water tank, activate the Fresh Water switch in the helm switch panel and open the nozzle on the fresh water shower. Allow the pump to run until all of the air is purged from the system and a steady stream of water is flowing from nozzle. Release the nozzle to stop the water flow. As the pressure builds, the pump will automatically shut off.



When properly primed and activated, the water system will operate much like the water system in a home. An automatic pressure sensor keeps the system pressurized. If the system has been recently filled or has not been used for an extended period, air bubbles may accumulate at the pump and the system may have to be reprimed. Whenever the boat is left unattended, the Fresh Water switch should be placed in the OFF position.



Fresh Water Fill



Fresh Water Shower Above Swim Platform

	CAUTION	
DO NOT ALLOW THE FRESH WATER PUMP TO RUN DRY. THE FRESH WATER PUMP WORKS ON DEMAND AND WILL NOT SHUT OFF AUTOMATICALLY WHEN THE TANK IS EMPTY. THIS CAN RESULT IN DAMAGE TO THE PUMP. ALWAYS TURN THE FRESH WATER SWITCH OFF WHEN THE SYSTEM IS NOT IN USE.		

Fresh Water Shower

There is a shower spray head in a special compartment above the swim platform. The shower has cold water and a retractable shower head with an on/off valve.

To use the cockpit shower, make sure the Fresh Water switch is on, then open the shower compartment cover and pull the shower head out. Activate the valve on the shower head to turn the water on. To conserve water, use the valve to turn the water on and off as you shower.

Fresh Water System

7.3 Fresh Water System Maintenance

Information supplied with water system components by the equipment manufacturers is included with this manual. Refer to this information for additional operation and service data.

The following items should be done routinely to maintain your fresh water system:

- Periodically remove and clean the water strainer located at the intake side of the pressure pump. To clean the strainer, make sure the Fresh Water switch is off. Rotate the strainer bowl counterclockwise to release it. Remove and clean the screen with fresh water. Lubricate the O-ring lightly with Teflon or silicon grease and reinstall the screen and strainer bowl.
- Periodically spray the pump and metal components with a metal protector.
- The batteries must be properly maintained and charged. Operating the pressure pump from a battery with a low charge could lead to pump failure.
- Add a commercially available potable water conditioner to the water tank to keep it fresh.



Fresh Water Pump & Strainer

Sanitizing the Fresh Water Tank

The freshwater system should be sanitized if it has not been used for a long period or you are unsure of the quality of the water in the system.

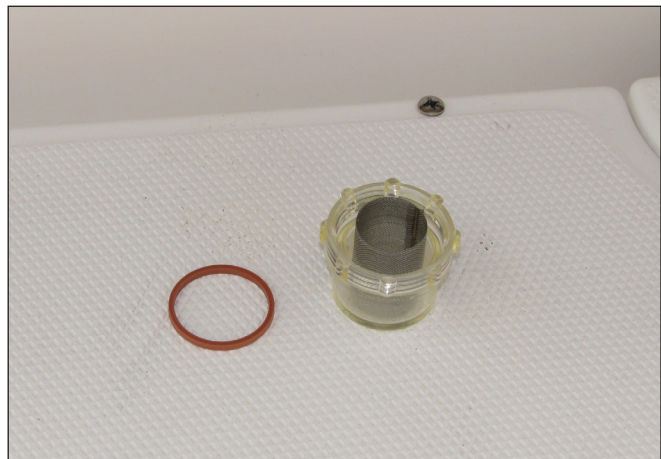

The following steps can be used to sanitize the system:

- Activate the system and pump out as much water as you can.
- Make a chlorine solution by mixing two ounces of household chlorine bleach in a gallon of water. This mixture will treat approximately fifteen gallons. If the water tank on your boat is larger or smaller than 15 gallons, then adjust the mixture accordingly. Always mix the chlorine with water in a separate container first and never add straight chlorine to the fresh water tank.
- Fill the water tank half full with freshwater and pour the mixture into the water tank. Top off the tank.
- Activate the system and allow the water to run from the washdown hose for about 1 minute. Let the treated water stand for 4-6 hours.



Typical Fresh Water Pump Strainer Removed for Cleaning

- Drain the system by pumping it dry and flush with several tank fills of freshwater.
- The system should now be sanitized and can be filled with freshwater. If the chlorine smell is still strong, it should be flushed several more times with freshwater.

	CAUTION	
THE FRESH WATER SYSTEM MUST BE PROPERLY WINTERIZED PRIOR TO WINTER LAY-UP. SEE SECTION ON WINTERIZING.		

RAW WATER SYSTEM

8.1 General

In the raw or seawater systems, the baitwell seawater pump is mounted to a seacock on a thru-hull fitting located in the aft systems compartment bilge. The water system pressure pump is connected to an auxiliary supply fitting at the base of the baitwell pump. Always make sure all valves are open before attempting to operate any component of the raw water system.

Priming the System

Make sure the seacock valve is open and the Raw Water switch in the helm switch panel is on. Run the pressure pump by turning on the raw water washdown hose until all of the air is purged from the system, then turn the hose off. Turn the Baitwell switch on and run the baitwell pump until all of the air is purged from the system, then turn the pump off.

The intake for the baitwell centrifugal pump is equipped with a scoop and ball valve. If the pump runs but will not prime, make sure the valve is open. If the pump still won't prime, it may be air locked. Make sure the valve is open and run the boat at or above 15 M.P.H. The water pressure from the scoop will force the trapped air through the pump and allow it to prime. If this procedure doesn't work, contact your Everglades dealer.

Closing the thru-hull valve before the boat is hauled from the water will help to eliminate air locks in the raw water system. The valve should also be closed whenever you leave the boat unattended.

Notice:

It may be necessary to reprime the raw water system if it is not used for an extended period and at the time of launching.

8.2 Raw Water System Operation

A high pressure pump, controlled by a pressure sensor, is activated by the Raw Water switch in the helm switch panel. When activated, the pressure switch will automatically control the pump that supplies the raw water hose connector.

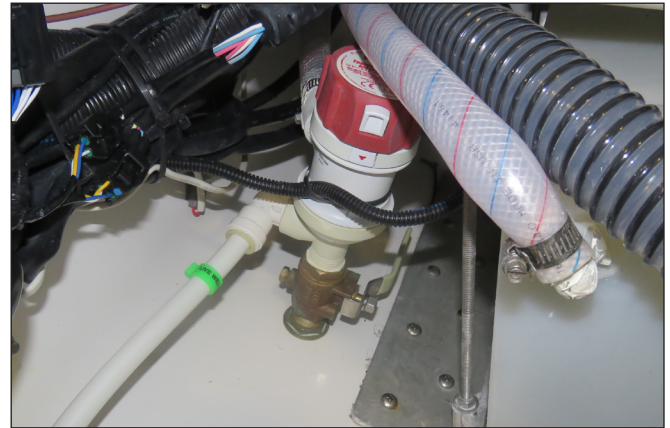

Baitwell Pump, Washdown Pump Supply Fitting & Seacock



Washdown Quick-Release Hose Connection

As the pressure builds in the system, the pump will shut off. When the system is in use and the pressure drops, the pump will turn on. The water system is equipped with a strainer on the intake side of the pump. The strainer should be checked frequently and cleaned as necessary.

Whenever the boat is left unattended, the Raw Water switch should be placed in the OFF position.

Washdown Hose Connector

The raw water washdown quick-release hose connection is located on the port side of the cockpit. The connector has an automatic valve that is always closed until the washdown hose is connected. The hose requires a special fitting that snaps into the connector and activates the automatic valve.

Raw Water System

The cover on the connector should always be in the closed position to keep the connector clean when the washdown hose is not attached. Contact your dealer for information on replacement fittings and hoses.

Make sure the Raw Water switch in the helm switch panel is on before using the washdown hose and that the washdown faucet valve or hose spray nozzles are off when the water system is activated.

CAUTION

DO NOT ALLOW THE WATER PUMP TO RUN DRY. THE PUMP WORKS ON DEMAND AND WILL NOT SHUT OFF AUTOMATICALLY IF NO WATER IS AVAILABLE. THIS CAN RESULT IN DAMAGE TO THE PUMP. ALWAYS TURN THE RAW WATER SWITCH OFF WHEN THE RAW WATER SYSTEM IS NOT IN USE.

8.3 Baitwell

Seawater is provided to the baitwell by a 12 volt circulation pump. This pump is designed to carry a constant flow of water to the baitwell. The pump does not have a pressure sensor and is activated by the Baitwell Pump switch in the helm switch panel. There is also a light in the baitwell that is activated by the Baitwell Light switch.

Notice:
If your boat is equipped with an optional 2nd livewell, it will have a separate pickup and pump.

An overflow built into the baitwell drain automatically controls the water level in the baitwell. Always turn the pump off at the switch panel when the baitwell is not in use.

To fill the baitwell, insert the plug into the drain fitting at the bottom of the baitwell. Make sure the seacock at the pump and the supply valve in the baitwell are open. Then activate the baitwell pump. When the water level reaches the overflow, it will begin to circulate.

The baitwell raw water intake is equipped with a high speed pickup that will supply water to the baitwell if the pump should fail and helps prime the system during normal operation. To supply water to the baitwell using the high speed pickup, make sure the seacock valve is open and run the boat at a speed above 15 miles per hour. Water will circulate through the baitwell and out the overflow.



Baitwell Overflow, Intake Valve, Drain Plug & Drain Fitting

To drain the baitwell, turn off the baitwell pump and remove the plug in the drain fitting. When the baitwell has completely drained, use the washdown hose to flush the baitwell and drain of debris. The baitwell seacock valve should be closed whenever the baitwell is not in use. This will prevent water from entering the baitwell while the boat is cruising.

Notice:
Do not use the baitwell as a dry storage area when it is not in use. Seawater could accidentally be delivered to the baitwell from the thru-hull fitting and damage equipment stored there.

CAUTION



A RUPTURED RAW WATER INTAKE OR PRESSURE LINE COULD CAUSE THE BOAT TO TAKE ON WATER. ALWAYS TURN THE RAW WATER SYSTEMS OFF AND CLOSE THE THRU-VALVES WHEN LEAVING THE BOAT UNATTENDED.

Raw Water System

8.4 Raw Water System Maintenance

The following items should be done routinely to help maintain your raw water system:

- Check hoses, particularly the seawater supply lines, for signs of deterioration. Tighten fittings or replace deteriorated hoses and components as necessary.
- Periodically remove and clean the water strainer located near the intake side of the washdown pump. To clean the strainer, make sure the Raw Water switch is off and close the valve at the thru-hull fitting. Rotate the strainer bowl counterclockwise to release it. Remove and clean the screen with fresh water. Lubricate the O-ring lightly with silicon or Teflon grease and reinstall the strainer bowl.
- Spray pumps and thru-hull valves with a protective oil periodically.
- Fishboxes and baitwells should be drained and cleaned after each use.
- Operate all seacock valves at least once a month to keep them operating properly.

	CAUTION	
<p>SHOULD A HOSE RUPTURE, TURN THE PUMP OFF IMMEDIATELY. ALWAYS CLOSE THE THRU-HULL VALVE WHEN PERFORMING MAINTENANCE ON A SEAWATER PUMP.</p>		
<p>THE BATTERIES MUST BE PROPERLY CHARGED. OPERATING ANY PUMPS FROM A BATTERY WITH A LOW CHARGE MAY LEAD TO A PUMP FAILURE.</p>		
<p>THE RAW WATER SYSTEM MUST BE PROPERLY WINTERIZED PRIOR TO WINTER LAY-UP. SEE SECTION ON WINTERIZING.</p>		



Raw Water Pressure Pump & Sea Strainer

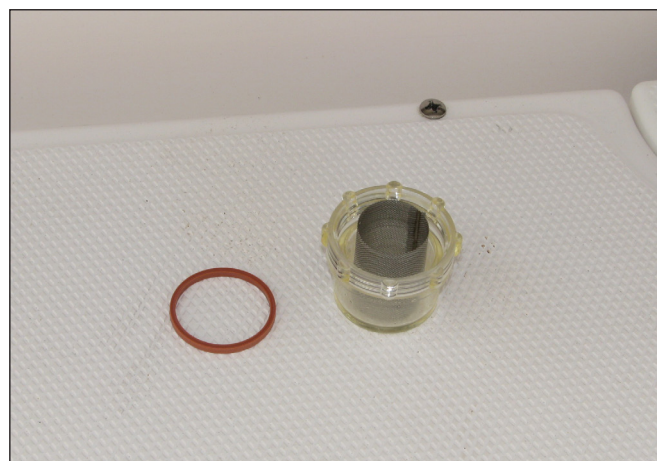

Typical Raw Water Pump Strainer Removed for Cleaning

NOTES

DRAINAGE SYSTEMS

9.1 General

All water is drained by gravity to overboard thru-hull fittings located in the hull above the water line. It is important to check the drain system frequently to ensure it is free flowing and that the hoses on the thru-hull fittings are secure and not leaking. Please review the drainage schematic to become familiar with the location of the drain thru-hull fittings.

9.2 Cockpit Sole Drains

Your Everglades has two scupper drains located in the rear of the cockpit.

A ball valve in each drain hose can be closed to prevent seawater from flowing into the cockpit or bilge through the drain system in an emergency. These valves should always be open during normal operating conditions.

Before operating the vessel, confirm that the ball valves are open. Failure to open the valves could result in inadequate cockpit drainage. The valves are located in the bilge and can be accessed through the bilge hatch. Make sure to open and close each valve at least once a month to keep the valves free and ensure they will work if you need them.

Water is channeled away from all hatches by a gutter or drain rail system. The water then drains overboard through the scupper drain system or thru-hull fittings in the hull.

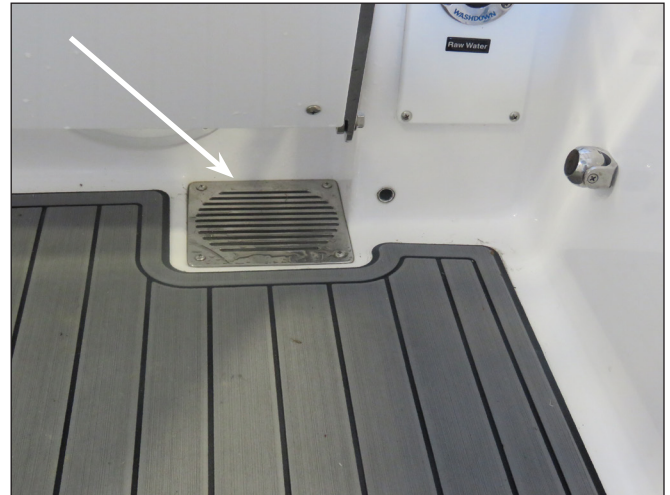



Cockpit Scupper Drain

9.3 Hardtop Drains

There is a hole drilled in the leg bases on Hardtop frame to prevent water from being trapped within the legs. Additional drain holes are drilled in the tubing to drain other areas as required.

Always make sure the drain holes are clear when the boat is laid up for the winter. Water trapped inside the legs and frame could freeze and cause the legs to split.

	WARNING	
CONFIRM THAT THE BALL VALVES FOR THE COCKPIT DRAINAGE ARE OPEN BEFORE OPERATING THIS VESSEL. INADEQUATE DRAINAGE COULD OCCUR IF THE BALL VALVES ARE CLOSED.		

9.4 Bilge Drainage

There are two bilge pumps, aft bilge 1 and aft bilge 2/emergency. The bilge pumps are activated both manually by switches in the helm switch panel and automatically by water activated switches located next to the pump. The automatic switches are connected directly to the batteries. They are protected by fuses in the continuous power fuse panel and remain activated when the battery switches are in the OFF position. The manual switches are supplied current when the battery switch is activated.

All bilge pumps pump water out of thru-hull fittings located above the waterline in the hull sides. Aft bilge 1 pump and automatic switch are located near the transom. Aft bilge 2/emergency pump and automatic switch are located just aft of bilge pump 1.

The manual bilge pump switches should be activated briefly each time the boat is used. This will ensure that the pumps are operating properly and increase the service life of the pumps. The automatic switches should be manually tested periodically to verify operation. This is particularly important before operating the boat offshore.

Aft bilge 2/emergency pump and automatic switch is mounted higher in the bilge than aft pump 1. Aft bilge 2/emergency pump is activated if the bilge water level rises above the normal operating range of the bilge pump 1 automatic switch.

Bilge High Water Alarm

Bilge pump 2 automatic switch will sound an alarm at the same time the emergency bilge pump is activated if the bilge water level rises above the normal operating range of the bilge pump 1 automatic switch. The alarm and bilge pump 2 automatic switch is connected to the batteries. It remains activated when the battery switches are in the OFF position and the batteries are connected.

Garboard Drain Plug

When the boat is out of the water the bilge can be drained by a garboard drain located in the transom near the bottom of the hull. The plug should be removed whenever the boat is hauled out of the water and installed just prior to launching. It is important to check the drain plug regularly to make sure it is tight.



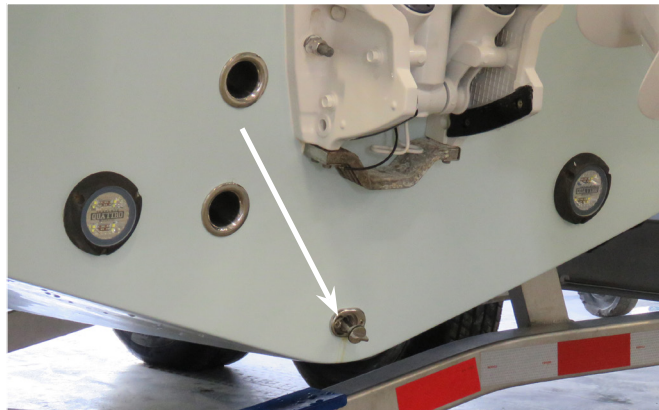

Aft Bilge Pumps & Automatic Switches





Garboard Drain Plug

Important:

Any oil spilled in the bilge must be thoroughly removed and properly disposed of before operating the bilge pump. The discharge of oil from the bilge is illegal and subject to a fine.

 WARNING 
A LOOSE DRAIN PLUG WILL ALLOW SEAWATER TO ENTER THE BILGE AND COULD CAUSE THE BOAT TO SINK. IT IS VERY IMPORTANT TO CHECK THE DRAIN PLUG FREQUENTLY TO ENSURE IT IS PROPERLY TIGHTENED.

 CAUTION 
THE FEDERAL WATER POLLUTION CONTROL ACT PROHIBITS THE DISCHARGE OF OIL OR OILY WASTE INTO OR UPON THE NAVIGABLE WATERS OF THE UNITED STATES OR THE WATERS OF THE CONTIGUOUS ZONE IF SUCH DISCHARGE CAUSES A FILM OR SHEEN UPON OR A DISCOLORATION OF THE SURFACE OF THE WATER OR CAUSES A SLUDGE OR EMULSION BENEATH THE SURFACE OF THE WATER. VIOLATORS ARE SUBJECT TO A PENALTY OF \$10,000.



Forward Fishbox



Typical Forward Fishbox Pump Out System

9.5 Fishboxes, Baitwell & Storage Compartment Drains

Forward Fishbox

The forward fishbox below the cockpit sole is drained overboard by a pump out system located in the bilge, forward of the batteries in the head compartment. The pump out system is activated by the Fishbox switch in the helm switch panel.

Monitor the water level as the pump drains the fishbox and turn it off immediately when draining is complete. The pump will be damaged if it is allowed to run dry for more than 30 seconds.

The fishbox hatch gutter drains by gravity to a seacock valve on a thru-fitting in the hull. The access is located below the porta potty. The seacock valve should be open during normal operation.

Bow Storage Compartments/Coolers & Rod Lockers

The forward storage/cooler compartments below the bow seats drain by gravity to the fishbox.

Baitwell and Cooler

The baitwell and cooler are drained by gravity to thru-hull fittings in the hull. The baitwell overflow drains to the drain system.

Cup Holder Drains

Most cup holders in the helm and cockpit areas drain by gravity to the cockpit sole. The forward bow seat cup holder drains to the anchor locker.



Bow Storage Compartments/Coolers

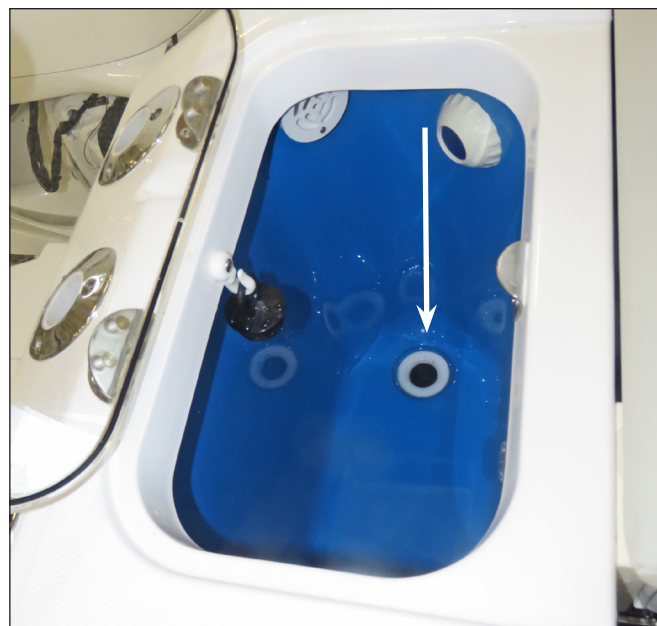

Baitwell Drain Fitting

Drainage Systems

Console Seat Storage Compartment/Cooler

The storage compartment/cooler below the forward console seat is drained to the thru-fitting and seacock located below the porta potty.



Console Seat Compartment/Cooler

Systems Compartment Hatch

The systems compartment hatch gutter drains to a thru-hull fitting and seacock in the transom. The thru-hull fitting and seacock are accessed through the splashwell access plate.

Forward Fishbox Hatch

The forward fish box gutter drains to a thru-hull fitting with a seacock located in the hull below the porta potty.

Rope Locker Drain

The rope locker drains overboard through a small drain hole in the bottom of the locker. It is important to inspect the drain frequently to remove any accumulated debris.



Rope Locker Drain

9.6 Drainage System Maintenance

It is essential that the following items be done periodically to maintain proper drainage of your boat:

- Clean the cockpit gutters with a hose to remove debris that can block water drainage.
- Clean the hardtop leg drain holes. This is especially important just before winter lay-up.
- Clean the bilge pump strainers of debris and check the bilge for foreign material that can cause the automatic switch to malfunction.
- Frequently test the automatic bilge pump switches for proper operation. This is accomplished by using a garden hose to flood the bilge until the water level is high enough to activate the pumps.
- Flush all gravity drains with fresh water to keep them clean and free flowing.

- Clean and flush fishboxes, coolers and storage boxes with soap or a bilge cleaner and fresh water after each use to keep them clean and fresh.
- Operate all seacock valves at least once a month to keep them operating properly.

Note: All drains and pumps must be properly winterized before winter lay-up.

CAUTION

NEVER USE HARSH CHEMICAL DRAIN CLEANERS IN MARINE DRAIN SYSTEMS. PERMANENT DAMAGE TO THE HOSES AND FITTINGS MAY RESULT.

VENTILATION SYSTEM

10.1 Cabin Ventilation

Cabin Door & Vents

Vents in the console door provide ventilation to the head compartment below the center console. Before using the head in hot weather, it is best to open the door for several minutes to provide maximum ventilation and cool the head compartment as much as possible.

Make sure the door is fully latched in the closed position when the head compartment is not being used and before operating the boat above idle speed.

Port Window

An opening port window is located in the side of the head compartment. The port window is equipped with a screen and secured in the closed position by three twist action locks. The locks should be adjusted so they are tight enough to seal the window in the closed position, but not so tight that they break the plastic.

Always make sure the window is closed and secured with the cam levers whenever the boat is underway. Sea spray could enter the head compartment through the open window and damage equipment or items stowed there.



Console Door & Vents



Cabin Port Window & Twist Action Locks



Port Window Open

Ventilation System

10.2 Windshield Ventilation

The windshield can be lowered to provide ventilation at the helm and improved visibility. The windshield is raised and lowered by hydraulic cylinders activated by an electric hydraulic pump in the aft systems compartment. The system is controlled by the Windshield switches in the helm switch panel.

To lower the windshield, press and hold the Down switch until the windshield is lowered to the desired position, then release the switch. To close the windshield, press and hold the Up switch until the windshield is completely closed. Always release the switch immediately when windshield reaches the full down or closed position.



Opening Windshield Raised

10.3 Bilge Ventilation

Ventilation to the bilge is provided by vents located on each side of the cockpit liner, below the gunnels. The vents provide air circulation in the bilge compartment to reduce odors, mildew and provide ventilation for the batteries. Make sure to keep these vents clear and unobstructed.

10.4 Maintenance

- Periodically lubricate all hinges and latch assemblies with a light oil.
- Keep the windshield slide tracks clean. Periodically coating the tracks with silicone spray will reduce friction and keep the windshield sliding smoothly.
- Periodically clean and coat gasket materials with silicone to help keep them pliable.



Windshield Switches

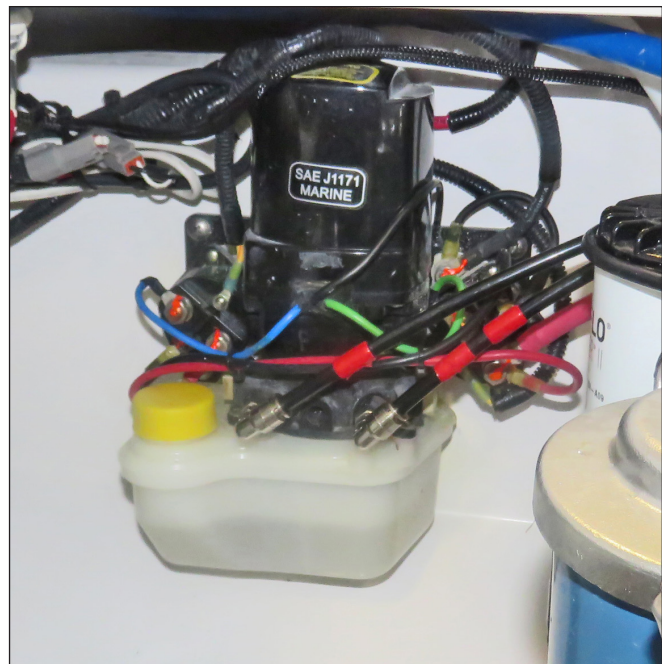

Hydraulic Pump System for Windshield
In Aft Systems Compartment

EXTERIOR EQUIPMENT

11.1 Deck Rails & Deck Hardware

The rail system and hardware fittings have been selected and installed to perform specific functions. Hand rails are installed to provide a handhold in certain areas of the boat. You should make sure you keep at least one hand on the handholds as you move about the boat.

Fenders or mooring lines should be secured to the cleats or optional fender pins and not to rails or stanchions. The cleats on your boat are retractable and flush with the deck when not in use. To use the cleats, pull up on the center of the cleat until it locks in the mooring position. Be sure a clear lead exists when running dock lines or anchor lines. A line inadvertently run around a stanchion or over the rail could cause damage.

Important:

All fittings must be periodically inspected for loose fit, wear or damage. Any problems should be corrected immediately.



WARNING



EVERGLADES BOATS ARE NOT EQUIPPED WITH HARDWARE DESIGNED FOR TOWING PURPOSES. THE MOORING CLEATS ARE NOT TO BE USED FOR TOWING ANOTHER VESSEL OR HAVING THIS BOAT TOWED.



Stern Cleat Deployed



Stern Cleat Retracted

11.2 Rope Locker & Optional Windlass

Bow Roller

The bow roller is built into the hull and equipped with hardware that allows the anchor to be operated and stored at the roller. The roller assembly, anchor line and chain binder are concealed below a hatch in the deck. The anchor line is stored in the rope locker and routed out the locker or optional windlass, through the roller and connected to the anchor chain. A chain binder is provided to secure the anchor when it is raised. An anchor cleat near the chain binder is used to secure the anchor line when the anchor is deployed. The cleat is also used to keep the anchor tight in the roller when it is raised if the boat is not equipped with a windlass. Always make sure the anchor is



Bow Roller & Anchor

Exterior Equipment

properly secured by the chain binder when it is in the stored position on the roller.

The chain binder is accessed by opening the hatch and is designed to connect to a link in the anchor chain when the anchor is hauled in. To release the binder, pull the anchor chain in slightly to relieve the tension on the binder, then release the binder from the chain.

To secure the anchor in the up and stored position, raise the anchor until it seats firmly in the roller with the chain snug using the windlass or cleat. Attach the chain binder to a link in the chain. Before getting underway after hauling the anchor, always make sure the binder is properly attached to the anchor chain link and the hatch is closed and latched.

Anchor Rope Locker

The anchor rope locker is concealed below a recessed compartment that is accessed through a hatch in the deck. A flush, twist lock latch secures the hatch in the closed position. Always make sure the hatch is closed with the latch in the secured position before operating the boat above idle speed.

The rope locker and anchor line is accessed through an opening in the bottom of the compartment. The anchor line is always stored in the rope locker and there is an eye fitting to secure the bitter end of the anchor line.

The rope locker is designed for the anchor line and not for storing anchors or additional anchor lines. Do not store anchors or any heavy objects in the locker. Anchors and weights for floating markers will bounce and damage the hull or rope locker if they are stored there. They will also interfere with the operation of the optional windlass or deploying the anchor manually. Always store and secure additional anchors and weights in a storage compartment in the cockpit, as far aft as possible.



Chain Binder, Rope Locker, Anchor Line Cleat and Bow Roller

The rope locker is drained by a fitting in the hull side near the bottom of the locker. It is very important to check the drain frequently to make sure it is clean and free flowing.

Periodically remove the anchor line from the rope locker, rinse it with fresh water and allow it to dry in the sun. Cleaning the anchor line regularly will reduce odors in the rope locker and increase the life of the line.

The line should also be inspected for abrasions or signs of deterioration. Replace the line if it shows any sign of damage or deterioration. If the boat is equipped with a windlass, it is important to replace the anchor line with a new line of the type recommended or supplied by the windlass manufacturer.

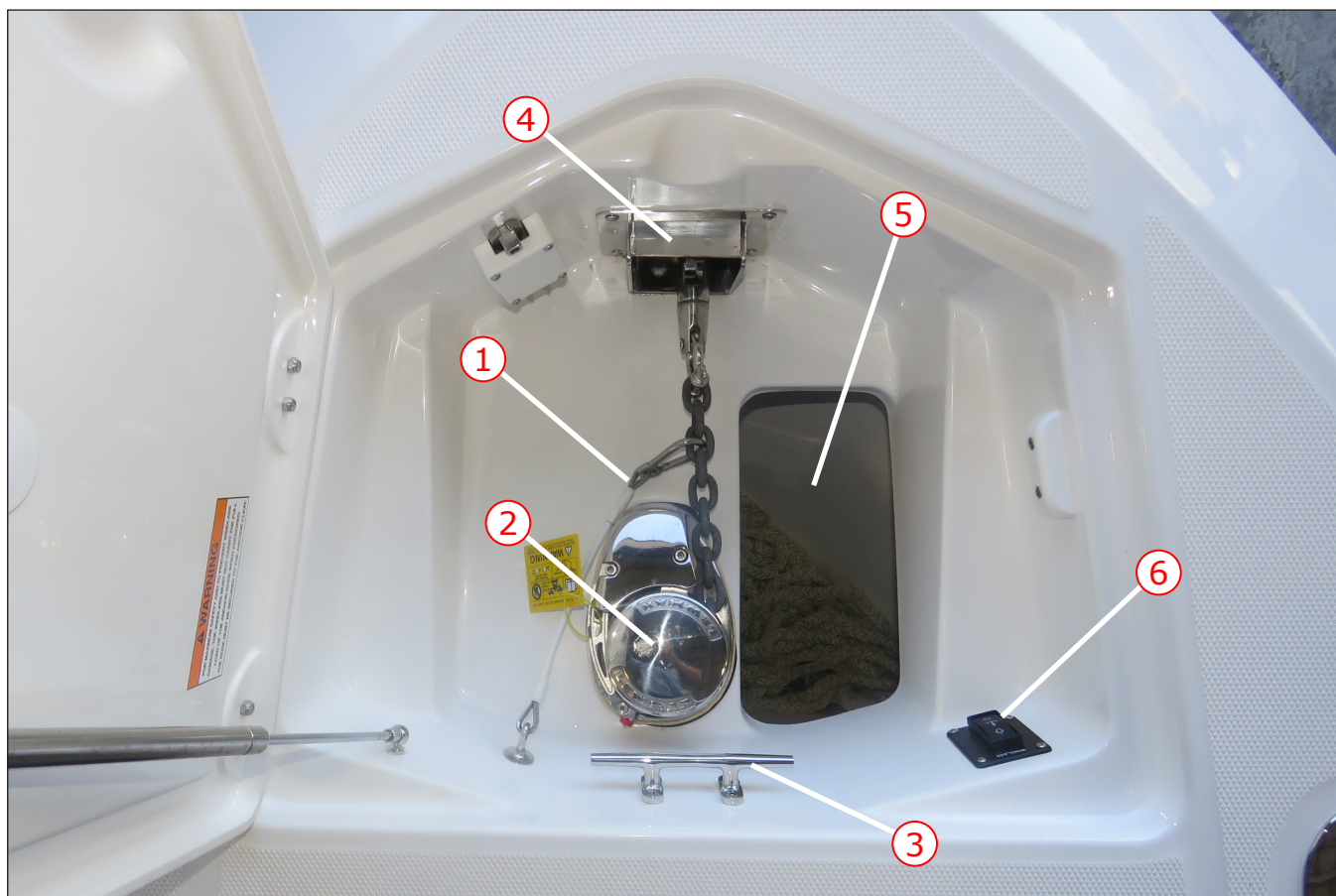

Windlass Compartment & Rope Locker

- | | |
|----------------------|------------------------|
| 1. Chain Binder | 4. Bow Roller Assembly |
| 2. Windlass | 5. Rope Locker |
| 3. Anchor Line Cleat | 6. Windlass Switch |

Windlass (Optional)

The windlass is mounted in the compartment below the hatch in the deck. The anchor is stored on the roller and is raised and lowered by the windlass. The anchor line is stored in the rope locker and routed out through the windlass to the anchor chain.

The anchor is lowered by releasing the anchor chain from the chain binder and pressing the DOWN switch at the helm or using the windlass switch in the windlass compartment. The windlass control switches are protected by circuit breakers and fuses in the battery compartment and below the helm.

After the anchor is set, the windlass must not be left to take the entire force from the anchor line. Boats lying to their anchor in a high swell or heavy weather conditions will snub on the line. This can cause slippage or apply excessive loads to the



Windlass UP/DOWN Switches in Helm Switch Panel

Exterior Equipment

windlass. The line should be made fast to the cleat provided to relieve the load on the windlass.

The anchor is hauled in by releasing the line from the cleat and pressing the UP switch at the helm or using the windlass switch in the windlass compartment. Always start the engine before hauling the anchor and motor up to the anchor as the line is retrieved to relieve the load on the windlass. Once the anchor is retrieved, independently secure the anchor to the chain binder to prevent it from being accidentally released. This is especially important while the boat is underway.

The windlass manufacturer provides an owner's manual with its product. It is extremely important that you read the manual and become familiar with the proper care and operation of the windlass. Refer to the Operation chapter for tips on anchoring your boat.



Windlass Rocker Switch in Windlass Compartment



WARNING



A WINDLASS MUST BE USED WITH CARE. IT IS EXTREMELY IMPORTANT THAT YOU READ THE OWNER'S MANUAL AND BECOME FAMILIAR WITH THE SAFETY INSTRUCTIONS AND PROPER OPERATION OF THE WINDLASS BEFORE USING IT WITH YOUR BOAT. ALWAYS ENSURE THAT LIMBS, FINGERS, HAIR AND CLOTHING ARE KEPT CLEAR OF THE WINDLASS AND ANCHOR LINE DURING OPERATION.

A PARTIALLY LOWERED AND LOOSE ANCHOR CAN CAUSE CONSIDERABLE DAMAGE TO THE HULL. DO NOT USE A WINDLASS AS A SOLE MEANS OF SECURING AN ANCHOR IN THE BOW PULPIT. ALWAYS SECURE THE ANCHOR TO A CHAIN BINDER BEFORE OPERATING YOUR BOAT.

Exterior Equipment

11.3 Hull

Engine Mounting System



Your Everglades is equipped with an engine mounting system that is integrated into the hull and stringer system that is designed to distribute the stresses of engine weight and thrust throughout the entire hull.

The engine cowling, hoses and cables or the transom gel coat can be damaged by tilting the engine to the full up position with the engine turned to the wrong position. You should monitor the engine as it tilts to determine best full tilt engine position for your boat.

A swim platform built into the engine mounting system with a boarding ladder and grab rail is standard on your boat.

Boarding Ladder

A telescoping boarding ladder is recessed into a compartment in the swim platform below a hatch. To use the ladder, make sure the engines are off and the steering wheel is turned straight ahead or slightly to port to move the propellers as far away from the ladder location as possible. Open the hatch and rotate the ladder out of the recess to the down position. Pull the bottom step to extend the ladder, then close the hatch. The ladder must be retracted, folded into the recess and the hatch closed before starting the engines.

	WARNING	
<p>MOVING PROPELLERS ARE DANGEROUS. THEY CAN CAUSE DEATH, LOSS OF LIMBS, OR OTHER SEVERE INJURY. DO NOT USE THE SWIM PLATFORM OR LADDER WHILE AN ENGINE IS RUNNING. STOP THE ENGINES IF DIVERS OR SWIMMERS ARE ATTEMPTING TO BOARD. ALWAYS PROPERLY STORE THE LADDER BEFORE STARTING THE ENGINES.</p>		

Unassisted Boarding Situations

When using the swim platform ladder in an unassisted boarding situation in deep water, hold the swim platform and brace your feet against the transom and hull side for stability. Then open the ladder hatch and rotate the ladder out of the recess to the down position with your free hand. Hold the side rail of the ladder for stability, then use your free hand and feet to extend the ladder. Close the hatch and use the ladder side rails and platform grab rail for stability while boarding. Remember to retract the ladder, fold it into the recess and close the hatch before starting the engines.



Swim Platform & Engine Mounting System



Ladder Folded in Platform Recess



Ladder Deployed

Exterior Equipment

Trim Tabs

The trim tabs are located on the transom below the swim platform. Trim tabs are an important part of the control systems. Refer to the Helm Control Systems chapter for detailed information on the trim tabs.

Underwater Lights (Optional)

LED underwater lights are mounted in the transom, below the water line. The lights are activated by the Underwater switch at the helm and should only be used when the boat is in the water with the lights submerged.

Heavy Duty Bow Eye (Optional)

The heavy duty towing package includes a heavy duty bow eye. The eye includes a welded stainless steel plate with internal bow reinforcement and backing plates that distribute the force on the bow eye to a larger area of the hull than with the standard bow eye. This option should always be selected if you intend to tow the boat behind a larger vessel.



Typical Heavy Duty Bow Tow Eye



DANGER



TOWING A BOAT BEHIND A LARGER VESSEL REQUIRES SPECIAL KNOWLEDGE AND SKILL. THE USE OF TOW LINES OR HARDWARE NOT INTENDED FOR TOWING OR RATED FOR THE FORCES EXERTED ON EQUIPMENT DURING THE TOW IS EXTREMELY DANGEROUS AND CAN CAUSE SEVERE INJURY OR DEATH TO PASSENGERS IF THAT EQUIPMENT FAILS. NEVER TOW THE BOAT BEHIND A LARGER VESSEL USING THE STANDARD BOW EYE OR A TOW LINE, HARNESS OR OTHER EQUIPMENT NOT RATED FOR THE EXPECTED LOADS EXPERIENCED DURING THE TOW. IF YOU ARE NOT EXPERIENCED IN TOWING A VESSEL, CONSULT WITH AN OPERATOR AND A MARINE FACILITY EXPERIENCED IN TOWING VESSELS FOR HELP SELECTING PROPER EQUIPMENT AND FOR TRAINING.



CAUTION



BOATS THAT ARE TOWED BEHIND LARGER VESSELS REQUIRE SPECIAL MAINTENANCE. ATTENTION TO THE ALUMINUM AND STAINLESS STEEL HARDWARE IS ESSENTIAL. SALT SPRAY, SALTY STEAM AND CHEMICALS IN EXHAUST GASES ARE PARTICULARLY CORROSIVE AND WILL DAMAGE THE SURFACE OF STAINLESS HARDWARE OR ANODIZED AND POWDER COATED ALUMINUM. IT IS IMPERATIVE THAT THE BOAT AND HARDWARE ARE CLEANED THOROUGHLY AT THE COMPLETION OF EACH TRIP OR AT THE END OF EACH DAY ON LONG CRUISES TO REDUCE ACCELERATED DETERIORATION AND PREMATURE CORROSION TO ALUMINUM, STAINLESS STEEL AND OTHER COMPONENTS ON THE BOAT.

Exterior Equipment

11.4 Cockpit Features

General



Most hatches and doors in the cockpit are secured with automatic push to close latches. Other hatches are secured with draw or cam latches. Gas charged springs are used on most hatches that help raise the hatches and hold them in the open position.

Some large hatches in the cockpit sole are secured with special flush mounted, twist lock latches with handles that store flush in the latch in the latched position. Always make sure that all hatches are closed with the latches in the secured position before operating the boat above idle speed.

Round access plates or removable storage compartments in the sides of the cockpit liner provide access to fill hoses and fittings. Other access plates in the cockpit sole provide accesses to fuel supply lines, fuel gauge sender and fuel fill and vent hose connections on the fuel tank.



Hatch Twist Lock Latch & Gas Charged Spring

	WARNING	
<p>IN CERTAIN CONDITIONS, OPEN EXTERIOR DOORS AND HATCHES THAT ARE NOT SECURED PROPERLY CAN SLAM CLOSED UNEXPECTEDLY AND CAUSE INJURY TO PASSENGERS OR DAMAGE TO THE BOAT. SOME DOORS AND HATCHES ARE EQUIPPED WITH SPECIAL FASTENERS, HATCH LIFTERS, MAGNETIC LATCHES OR SNAPS AND STRAPS TO SECURE THEM IN THE OPEN POSITION. ALWAYS MAKE SURE THAT THESE HATCHES AND DOORS ARE PROPERLY SECURED WHENEVER THEY ARE IN THE OPEN POSITION.</p>		



Side Utility Door Open

Side Utility Door

A utility door is located in the port hull side. The door makes boarding and exiting the boat much easier in many docking situations.

A magnetic latch in the cockpit holds the door when it is open and a special latch mounted on the inboard side of the door secures it when it is closed. The door latch has a spring loaded safety button. When the door is closed, make sure the latch is completely engaged and that the safety button is engaged to prevent the latch from opening accidentally.

The door should only be opened when the boat is not in motion with the engines shutdown. The door must be secured in either the open position to the side of the cockpit or in the closed position



Side Utility Door Closed

Exterior Equipment



with the main latch and safety pin. Never leave the side door unlatched.

Notice:

Periodically inspect the door hinges and hardware for wear, damage or loose fit. Any problems found should be corrected immediately.





Utility Door Latch & Safety Release Button

	WARNING	
<p>THE UTILITY DOOR SHOULD BE CLOSED AND PROPERLY LATCHED WHENEVER THE ENGINE IS RUNNING. NEVER OPEN THE DOOR WHILE UNDERWAY OR IN ROUGH SEA CONDITIONS. IN CERTAIN SITUATIONS, AN OPEN UTILITY DOOR COULD ALLOW A SUBSTANTIAL AMOUNT OF WATER TO ENTER THE COCKPIT CREATING A POTENTIALLY DANGEROUS CONDITION.</p> <p>OPERATING THE BOAT UNDER POWER WITH THE UTILITY DOOR OPEN MAY ALLOW PERSONS TO FALL OVERBOARD AND INTO THE BOAT PROPELLER OR TO BE LOST IN OPEN WATER. ALWAYS CHECK TO MAKE SURE THE UTILITY DOOR IS PROPERLY CLOSED AND LATCHED BEFORE STARTING THE ENGINE. NEVER OPERATE THE BOAT UNDER POWER WITH THE DOOR OPEN.</p>		

Side Boarding Ladder (Optional)

The side boarding ladder is mounted to special brackets in a bow seat storage compartment when it is stored. To use the ladder, remove it from the storage clips and mount it to bracket below the side utility door.

To prevent damage to the ladder or hull side, the ladder must be removed from the bracket and properly secured in the storage clips before starting the engines.

	WARNING	
<p>MOVING PROPELLERS ARE DANGEROUS. THEY CAN CAUSE DEATH, LOSS OF LIMBS OR OTHER SEVERE INJURY. DO NOT USE THE UTILITY DOOR OR LADDER WHILE THE ENGINES ARE RUNNING. STOP THE ENGINES IF DIVERS OR SWIMMERS ARE ATTEMPTING TO BOARD. ALWAYS PROPERLY STORE THE LADDER AND CLOSE THE DOOR BEFORE STARTING THE ENGINES.</p>		

Scupper Drain Ball Valve

Exterior Equipment

Stern Bench Seats

Your boat is equipped with forward facing bench seats in the rear of the cockpit. Each seat is designed to fold flush against the cockpit when it is not in use. Access plates behind each seat provide access to baitwell and cooler hose fittings or other components.

To use the seats, pull the top of the seat base out of the recess toward the cockpit. The side supports move out with the seat as it rotates out. When the seat is half way out, lift the rear of the seat with one hand while pushing the front of the seat down with the other hand until it stops in the seat position.

To store the seats, lift the front of the seat with one hand while pushing the rear of the seat down with the other hand until the seat rotates to the half closed position. Push the top of the seat firmly into the recess. The seat will automatically be secured in the stored position when it is completely folded into the recess.

Aft Systems Compartment Access Hatch

A hatch in the rear of the cockpit provides access to the fuel filter, pumps and other equipment in the stern bilge. The hatch is held open by two gas charged springs and secured closed with a flush, compression latch. Always make sure the hatch is closed with the latch in the secured position before operating the boat above idle speed.

Splashwell Access Plate

A removable access plate in the splashwell forward of the engine provides additional access to bilge pumps and the scupper drain valves. The access plate is threaded and removed by rotating it counter clockwise.

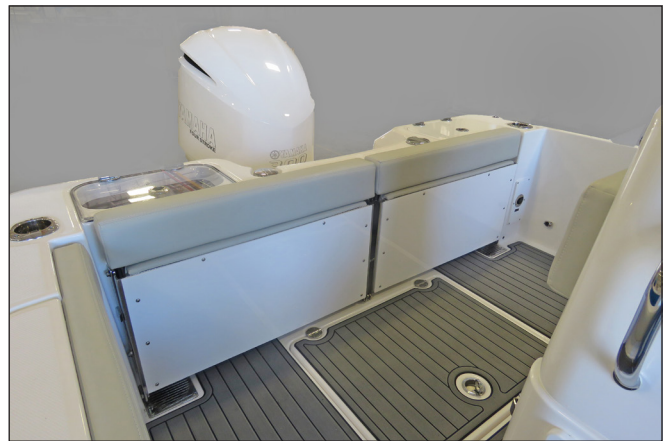

Stern Bench Seat Closed



Stern Bench Seat Down



Splashwell Access Plate



Aft Systems Access Hatch

Exterior Equipment

Aft Baitwell And Cooler

A baitwell is located in the starboard rear of the cockpit. A cooler on the port rear of the cockpit can be converted to a baitwell as optional equipment.

The cooler is insulated and drained by gravity to a thru-hull fitting in the hull. It is accessed through a hatch with a push to close latch. If the cooler is converted to a baitwell, it will be equipped and operate just like the standard starboard baitwell.

The baitwell in the starboard rear of the cockpit is provided as standard equipment. It is accessed through a clear acrylic hatch with a push to close latch and is equipped with a light, built in overflow and recirculation pump. It is drained by gravity to a thru-hull fitting in the hull.

The baitwell is supplied seawater by a centrifugal raw water pump located in the aft systems compartment. An overflow built into the side of the baitwell automatically controls the water level.

Notice:
If your boat is equipped with the optional port baitwell, it will be equipped with two baitwell pumps.

Baitwells should be drained and rinsed clean with fresh water after each use. Refer to the Raw Water System and Drainage Systems chapters for more information on the operation of the baitwell.

Cockpit Rod Rack

There is a recessed rod storage rack located below the gunnel on the starboard side of the cockpit. It is equipped with stretch cords to secure the rods to the racks. Always make sure the rods are properly secured in the storage racks with the rod tips forward.



Starboard Baitwell

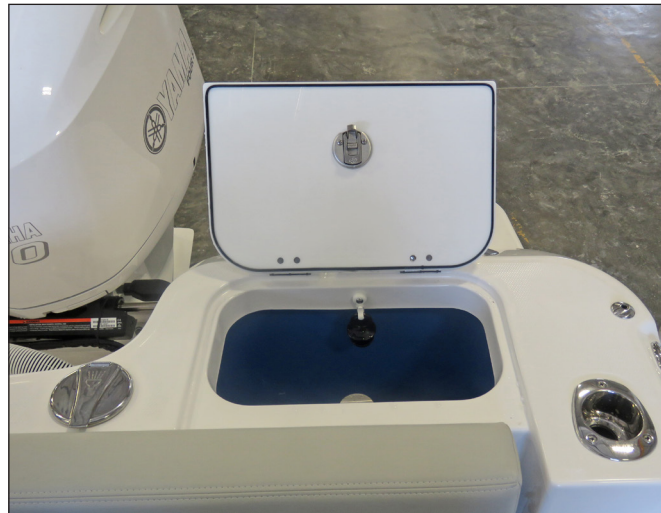

Port Cooler



Cockpit Rod Rack

Exterior Equipment



Helm Seat Bolsters Down



Helm Seat Bolsters Up

Helm Seats

The helm and passenger seats are equipped with a flip up bolster to provide more room between the seats and the helm. The bolsters convert the seats to a leaning post style seat with a backrest, allowing the operator and passenger to sit or stand at the helm. To convert each seat to a leaning post, lift the front of the seat cushion to raise the bolster and push it back above the seat cushion.

Arm rests on each side provide a more comfortable driving position. A molded in footrest on the rear of the console makes the helm more comfortable when the bolsters are set to the seat position.

Rotating Helm Seat Base

The helm seat base pivots to convert them to rear facing seats. A heavy duty, spring loaded latch built into the base automatically secures the seats in the forward or rear facing positions. A bolt latch on each side of the seat base secure the helm seats whenever the engine is running.

To rotate the helm seats to the rear facing position, push the sliding bolts down to release them from the base. Then pull the latch handle on the forward side of the base to release the latch. Continue holding latch handle and rotate the seats part way, then release the handle. Continue rotating the seats slowly to the rear facing position. The latch will automatically engage when the seats reach the rear facing position, securing the seats.



Helm Seat Pivot Latch and Sliding Bolt Latches

Exterior Equipment

A footrest on the rear of the seat base swings down to provide a foot rest when the seats are in the rear facing position. Sliding bolt latches secure the footrest when it is raised. To lower the footrest, release the bolt latches and lower the footrest. Make sure the footrest is secured with both latches when it is raised.

To rotate the seats back to the forward facing, helm position, pull the latch handle on the forward side of the base to release the latch. Continue holding latch handle and rotate the seats part way, then release the handle. Continue rotating the seats slowly to the forward facing position. The latch will automatically engage when the seats reach the forward facing position. Engage the sliding dead bolt on each side of the seat to lock the seats for operation.



Helm Seats Facing Aft & Footrest Deployed



WARNING



OPERATING THE BOAT IN HEAVY SEAS WITH THE SEAT BASE DEAD BOLTS UNLATCHED COULD CAUSE THE SEAT BASE LATCH TO FAIL. THIS WILL CAUSE THE SEATS TO SWIVEL UNEXPECTEDLY AND COULD RESULT IN LOSS OF CONTROL AND/OR INJURY TO PASSENGERS. ALWAYS MAKE SURE THE DEAD BOLTS ARE ENGAGED WHILE UNDERWAY.

Helm Seat Storage

There is a large storage compartment behind the bolster at the rear of the helm seats. The bolster is mounted to a door secured with a push to close latch that swings open to access to the compartment. Cables on each side of the door hold the door when it is open.

There are storage drawers and could be optional removable tackle storage trays behind doors on each side of the helm seat base. Lockable push to close latches secure each door when they are closed.



Rear Storage Compartment



Tackle Tray & Storage Drawer Compartments

Exterior Equipment



Side Storage Compartment



Forward Below Deck Storage Compartment

Side Storage/life Jacket Compartments

There are storage compartments on each side of the cockpit. The compartments are designed to accommodate life jackets or dunnage. Each compartment drains to the bilge and is accessed by a door secured with push to close latches.

Forward below Deck Fishbox

An insulated fishbox is located below the cockpit sole, just forward of the console seat. The hatch is equipped with two gas charged springs that hold the hatch in the open position. Gutters around the hatch drain by gravity to a thru-hull fitting in the hull below the water line. A flush, twist lock latch secures the hatch in the closed position. Always make sure the hatch is closed and latched before operating the boat above idle speed.

The fishbox is drained by a macerator pump activated by a switch in the helm switch panel. Be sure to monitor the water level in the fishbox closely during pump out operations and turn the pump off as soon as pumping is complete. The pump could be damaged if it is allowed to run dry for more than 30 seconds. The fishbox should be pumped out and cleaned after each use. Refer to the Drainage Systems chapter for more information on the fishbox system.

Bow Seats and Storage Compartments

There are two storage/cooler compartments located in the bow below the port and starboard seats. The compartments are insulated and can be used for dunnage or coolers. They drain to the fishbox by gravity. The seat bases are equipped with gas charged springs that hold them open. Draw latches secure the seat bases when they are closed.



Bow Seats with Backrest Installed



Bow Seat Storage Compartments

Exterior Equipment

To secure the seats in the closed position, stretch the latch until the hole in latch aligns with the retainer on the seat base. Press firmly to seat the latch on the retainer. Always make sure the hatches are closed and secured with the latches before operating the boat above idle speed.

The bow seat cushions are removable and are secured to the hatches or seat base with snaps. The cushions should be removed and stored in the head compartment or another safe location out of the weather when the boat is not being used.

The port and starboard bow seats are equipped with removable backrest cushions that convert each bow seat to a forward facing lounge. The backrest cushions are equipped with support stanchions that slide into receivers at the rear of each seat. The backrests can be removed and stored when not in use.

To install the backrests, slide the backrest supports into the receivers and push down firmly until each support bottoms in the receiver. To remove the backrests, move the backrest side to side slightly while simultaneously lifting to slide the backrest stanchions up and out of the receivers.

Casting Deck and Sun Lounge (Optional)

A removable insert converts the bow area into either a sitting area, sun lounge or a casting/fishing deck. The insert is secured with quick release hinges at the front and a sliding bolt latch on each rear side. The insert should be stored in a safe place when it is not being used.

To use bow area as a casting/fishing deck, remove the bow cushions and install the insert.

To install the insert, raise the back of the insert so it is at a 45 degree angle. Then slide the quick release hinge pins on the insert into the receivers on the seat base. Lower the rear of the insert until the bolt latch on each side is aligned with the receivers. Slide each bolt into the receiver. Make sure the spring loaded lock pin engages to secure each slide bolt.

Install the seat cushions and insert filler cushion to use the area as a sun lounge. Remove the filler cushion and insert to convert the bow area to a sitting area.



Backrest Cushions & Support Stanchions

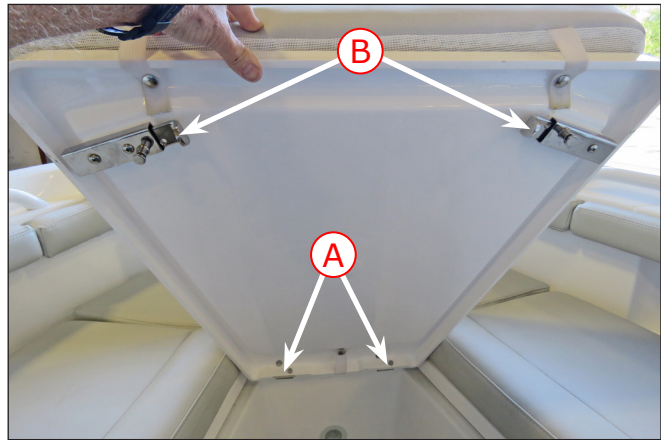

Removable Insert at 45 Degree Angle
& Quick Release Hinges Attached

A. Quick Release Hinges B. Sliding Bolt Latches & Lock Pins



Casting Deck Converted to a Sun Lounge

Exterior Equipment

11.5 Center Console & Helm

Helm

The steering, engine controls, engine instruments and switches for exterior equipment and navigation lights are located on the helm station. An area for flush mounted electronics is located forward of the steering and engine controls. The helm is also equipped with cup holders, storage trays, grab rails and a lockable storage compartment. There is also a MP3 and USB plug. A 12 volt accessory plug is an available option.

Two removable hatches in the head compartment provide access to the back of the helm for servicing equipment and installing electronics or other accessories. There are also fuse panels that provide protection for equipment installed by Everglades or other equipment added by you or dealer.

Windshield

Your boat is equipped with a tinted, tempered safety glass windshield. The front and side panels are also tempered safety glass.

The windshield slides down to provide ventilation at the helm and/or improved visibility. The windshield is lowered and raised by hydraulic cylinders on each side of the windshield. The cylinders are activated by an electric hydraulic pump located in the aft systems compartment that is controlled by the Windshield switches in the helm switch panel. You should always monitor the travel of the windshield as it is opened or closed and be ready to release the switch immediately when the windshield reaches the full up or down position. Refer to the Ventilation chapter for instructions on operating the windshield.

The windshield wiper and washer is standard equipment. A special lockout mechanism prevents the windshield wiper or washer from activating unless the windshield is in the full up (raised) position. You should always make sure the windshield is completely raised before activating the windshield wiper.

The windshield wiper should only be used when the windshield is wet. The windshield glass can be scratched by activating the wiper when there is dried salt or dirt on the windshield.

The windshield/hardtop frame is powder coated aluminum. Powder coated aluminum is very durable and provides excellent resistance to the corrosive effects of saltwater, however, it must be maintained properly and certain precautions must be observed.



Helm



Typical Opening Windshield In Lowered Position

The windshield should be washed after each use with soap water to keep it clean and reduce the corrosive effects of the saltwater. Saltwater allowed to remain on the windshield frame will eventually begin to attack the aluminum, usually around fasteners and hardware mounted to the frame.

Do not drill into or install any hardware to the aluminum frame. Poor maintenance or hardware and snaps mounted to the frame can void the warranty on the powder coated windshield/hardtop frame.



Refer to the Routine Maintenance chapter for more information on the care and maintenance of powder coated aluminum.

Exterior Equipment

Head Compartment Door

The head compartment door on the port side of the console is equipped with vents that provide ventilation for the head compartment.

It is very important that the head compartment door is closed and latched properly whenever the boat is operated above idle speed. The door is heavy and if it is not closed and properly latched, it could slam shut when the boat rocks and pinch someone's fingers between the door and cabin or damage the door.

	WARNING	
<p>NEVER LEAVE THE HEAD COMPARTMENT DOOR UNLATCHED. THE DOOR IS HEAVY SWINGS EASILY. IF THE DOOR IS LEFT UNLATCHED, IT COULD SLAM UNEXPECTEDLY AS THE BOAT ROCKS, DAMAGING THE DOOR OR CAUSING AN INJURY TO A PASSENGER. ALWAYS MAKE SURE THE DOOR IS PROPERLY SECURED IN THE OPEN OR CLOSED POSITION.</p>		



Head Compartment Door

Forward Console Seat and Cooler

A molded, insulated cooler that drains to the cockpit drain system is installed below the forward console seat. The console seat cushion is attached to a hinged hatch that is equipped with a gas charged spring that helps raise the hatch and holds it in the open position or closed position. The cooler should be drained and cleaned after each use.

The hatch and seat are held closed with two cam latches of the front of the seat. Always make sure the seat is closed and latched before operating the boat at cruising speeds.



Forward Console Seat & Cooler



11.6 Hardtop

The standard hardtop consists of a laminated fiberglass top mounted to a welded, powder coated aluminum frame that is bolted to the console. It is equipped with red/white LED overhead lighting for the helm and a mounting area for a VHF radio, stereo or other electronics. There is also storage in the rear of the hardtop liner, above the helm seats for life jackets and other light items.

The top is designed to accommodate radio antennas, radar antennas, forward and aft spreader lights, navigation lights, courtesy lights and rod holders. It could also be equipped with optional outriggers. The spreader lights, hardtop lights and retractable windshield are controlled by switches in the helm switch panel.

The hardtop is not designed to support the additional weight of heavy items like a life raft. Radar and electronics antennas must be mounted to the top between the front and rear legs in the mounting areas provided. Do not mount any antennas



Hardtop Storage

or equipment to the brow area forward of the front legs. The hardtop frame is not designed to support the weight of accessories in this area and could be damaged. The rear legs provide the wire chase for lights and antennas mounted to the top.

Exterior Equipment

Ski Tow

Some hardtop frames are equipped with a ski tow designed for pulling one average sized skier or wakeboarder. You should never tow more than one skier or wakeboarder from the ski tow. Towing more than one skier will put too much strain on the fabrication and could cause damage to the hardtop, console or cockpit sole.

Always use high quality tow ropes with attachment loops when pulling wakeboarders or skiers. The tow rope should always be attached using the attachment loops and never tied to the ski tow or to any type of metal hook. Tied ski ropes are very difficult to remove and metal hooks will damage the ski tow and the powder coated aluminum around it. Additionally, a metal hook can cause injury to your skier if it breaks under the strain of the tow.

When attaching a tow rope using the attachment loops, hold the attachment loop in one hand and pull a length of rope on the handle side of the loop through the loop, creating another 6" loop. Slide the loop just created over the ski tow fitting and pull the handle side of the rope to tighten the loop around the tow fitting. This procedure will attach the rope securely to the ski tow, be easy to remove and will not come off if the skier or wakeboarder falls.

Refer to Water Skiing in the Operation chapter for safety information on operating the boat with a skier.

Notice:

The warranty for the hardtop will be void if it is modified in any way or overloaded by towing too many skiers, wakeboarders or another boat. Additionally, if items like antennas, spotlights and other accessories are mounted improperly or in the wrong location, the war-



Typical Hardtop Ski Tow

ranty could be void. If you intend to add equipment or make modifications to the hardtop, you should contact your dealer or Everglades Customer Service to make sure the equipment you would like to add or the intended modification will not void the warranty.

11.7 Aftermarket Hardtop or Tower

Everglades does not recommend installing an after market hardtop or tower. An improperly designed or installed fabrication can cause structural damage to the deck structure and void the Limited Warranty. Additionally, Everglades will not be responsible for any damage resulting from the installation of a fabrication not installed at the Everglades factory. If you intend to install an aftermarket hardtop, upper helm station or tower on your boat, please contact your dealer or Everglades Customer Service.

INTERIOR EQUIPMENT

12.1 Head Compartment

The head compartment is equipped with a battery compartment and storage. The compartment drains to the bilge through a drain fitting in the floor.

Daylight and ventilation is provided by an opening port window and vents in the cabin door. There is also a 12 volt light in the head compartment that is activated by a switch in the light fixture.

Hatches in the rear bulkhead provide access to the back of the helm station to service helm components or install electronics. Other fuse panels for 12 volt accessories and electronics are located behind these panels. The stereo amplifier is also located on the rear bulkhead.

The batteries, battery charger, main 12 volt circuit breakers and continuous power fuse panel are located behind a removable hatch in the forward bulkhead. An access panel forward of the batteries provides access to the fishbox macerator pump and discharge valves.

The battery switch and circuit breakers that protect some 12 volt accessories is located on the starboard side of the compartment.



Head Compartment & Optional Portable Marine Head



Lower Access Hatch in Rear Bulkhead



12 Volt Light, Port Window
& Upper Rear Bulkhead Access Hatch



Forward Storage, Battery Compartment Access Hatch
& Battery Switch Panel

12.2 Portable Marine Head

A portable marine head is an available option. The system is made up of two major components, an upper tank and a lower tank. The upper tank contains the fresh water supply, a bellows pump, a seat and the lid. The bottom tank contains the flush valve, a waste holding tank, a chemical storage compartment and the drain nozzle. The components are secured together by a clamping mechanism when the portable head is ready for use.

In some areas the law requires that portable heads be equipped with an optional permanent deck mounted pump out system to evacuate the waste with a dockside pump. Boats with a portable head pump out will be equipped with a deck fitting marked "WASTE" located on the side of the console. Since this system is required to be permanent, the bottom waste tank cannot be removed and the only way to evacuate the system is by a dockside pump.

To use the portable head, add the recommended amount of holding tank deodorant to the waste tank and fill the fresh water tank. To flush after use, pull the waste valve handle straight out, then press the flushing bellows one or more times to rinse. To close and seal the waste holding tank, simply push the valve handle all the way in. Monitor the level in the waste tank and empty as necessary.

Maintenance

To keep your portable head operating properly it must be emptied and properly cleaned at least once every two weeks. Refer to the manufacturer owner's manual for detailed instructions on the proper operation of your portable head.



Portable Marine Toilet

Notice:

In some areas the law requires a waste pump out system on portable heads. If your boat is equipped with the waste pump out, make sure you know the laws for the areas in which you boat before modifying or removing the pump out system.

Notice

The portable head must be properly winterized before winter lay-up or for cold weather use. Refer to the manufacturer owner's manual for winterizing and cold weather instructions

ROUTINE MAINTENANCE

13.1 Exterior Hull & Deck

Hull Cleaning-Below The Water Line

When the boat is removed from the water, clean the outer bottom surface immediately. Algae, grass, dirt and other marine growth is easier to remove while the hull is still wet. Use a pressure cleaner or a hard bristle brush to clean the surface.

Bottom Painting

If the boat is to be left in saltwater for extended periods, the hull must be protected from marine growth by antifouling paint. Because of variations in water temperature, marine growth and pollution in different regions, a qualified boat yard in your area should be consulted when deciding what bottom paint system to apply to your hull. This is extremely important as pollution and marine growth can damage fiberglass hulls.

Use only standard antifouling paints and fiberglass wax removers and primers recommended by the antifouling paint manufacturer when preparing the hull for bottom paint. Light sanding, just enough to scuff the gel coat or a skip sand primer system can be used to prepare the hull for bottom paint. The use of a coating other than standard antifouling paint or epoxy barrier coatings are not recommended and will void the hull blister warranty.

Do not allow the hull antifouling paint to contact the outboard motors. Most antifouling paints designed for hull bottoms contain copper and can cause severe galvanic corrosion damage to the motors. Always leave at least a 1" barrier between the hull bottom paint and outboard motors.



CAUTION



SANDBLASTING THE HULL BOTTOM WILL DAMAGE THE FIBERGLASS. USE A FIBERGLASS WAX REMOVER AND SAND TO SCUFF THE GELCOAT SURFACE. THE INSTRUCTIONS AND RECOMMENDATIONS OF THE BARRIER COATING AND ANTIFOULING PAINT MANUFACTURERS SHOULD BE FOLLOWED EXACTLY.



CAUTION



BARRIER COATINGS AND BOTTOM PAINT SHOULD BE APPLIED ONLY BY QUALIFIED MARINE PROFESSIONALS IN A BOAT YARD OR DEALERSHIP THAT SPECIALIZES IN THEIR APPLICATION. USE ONLY STANDARD, HIGH QUALITY ANTIFOULING PAINTS AND BARRIER COATINGS FROM NAME BRAND MANUFACTURERS SUCH AS INTERLUX AND PETTIT.

DO NOT ALLOW THE HULL ANTIFOULING PAINT TO CONTACT THE OUTBOARD MOTORS. MOST ANTIFOULING PAINTS DESIGNED FOR HULL BOTTOMS CONTAIN COPPER AND CAN CAUSE SEVERE GALVANIC CORROSION DAMAGE TO THE OUTBOARD DRIVE UNIT. USE ONLY ANTIFOULING PAINT DESIGNED FOR OUTBOARD MOTORS IF APPLYING ANTIFOULING PAINT TO THE ENGINES. ALWAYS LEAVE A ONE INCH BARRIER BETWEEN THE HULL BOTTOM PAINT AND OUTBOARD MOTOR.

Most bottom paints require some maintenance. Proper maintenance is especially important when the boat is in saltwater and not used for extended periods or after dry storage. If the hull bottom has been painted with antifouling paint, contact your dealer or local boat yard for the recommended maintenance procedures.

Anodes

Sacrificial anodes are installed on the outboard motor, engine bracket and could be installed on the transom and/or trim tabs. The anodes are less noble than copper based alloys, stainless steel and aluminum. They will deteriorate first, protecting the more noble underwater hardware against galvanic corrosion.

They must be monitored if the boat is to be left in the water. Anodes should be checked monthly and changed when they are 75% of their original size. When replacing the anodes, make sure the contact surfaces are clean, shiny metal and free of paint and corrosion. Never paint over the anode.

Boats stored in saltwater will normally need to have the anodes replaced every 6 months to one year. Anodes requiring replacement more frequently may indicate a stray current problem within the boat or at the slip or marina. Anodes that do not need to be replaced after one year may

Routine Maintenance

not be providing the proper protection. Loose or low quality anodes could be the problem. Contact your dealer or Everglades Customer Service for the proper size and type of anodes to be used and the specific installation procedure.

There are 2 anodes on Yamaha engines. There is a large anode on the bottom of the clamp bracket and another anode on the anti-cavitation plate, above the propeller.

Fiberglass Gel coat

Normal maintenance requires only washing with mild soap and water. A stiff brush can be used on the nonskid areas. Kerosene or commercially prepared products will remove oil and tar which could be a problem on trailered boats. Harsh abrasive and chemical cleaners are not recommended because they can damage or dull the gel coat, reducing its life and making it more susceptible to stains. When the boat is used in saltwater, it should be washed thoroughly with soap and water after each use.

At least once a season, wash and wax all exposed fiberglass surfaces. Use a high quality automotive or boat wax. Follow the procedure recommended by the wax manufacturer. The washing and waxing of your boat will have the same beneficial effects as they have on an automobile finish. The wax will fill minute scratches and pores thus helping to prevent soiling and will extend the life of the gel coat or paint.

After the boat is exposed to the direct sunlight for a period of time, the gel coat or painted surfaces tend to fade, dull or chalk. A heavier buffing is required to bring the finish back to its original luster. For power cleaning use a light cleaner. To clean the boat by hand, use a heavier automotive cleaner. Before cleaning the surfaces, read the instructions given with the cleaner. After cleaning the surfaces, apply wax and polish all fiberglass surfaces except the nonskid areas.

Avoid the following on gelcoat surfaces:

- Do not use plastic or other nonporous (non-breathable) materials to cover gelcoat surfaces. Trapped moisture from condensation can cause gelcoat damage. Shrink wrap storage covers must be properly ventilated, including hull sides.
- Do not use abrasives, bleaches, ammonia, acids or harsh detergents. See your dealer for special marine formulations. Harsh abrasive and chemical cleaners are not recommended because they can damage or dull the gelcoat, reducing its life and making it more susceptible to stains.
- NEVER apply wax or buffing compound to a gelcoat surface in direct sunlight.

Chalking, stains and minor scratches can be removed in most cases with careful rubbing and polishing with appropriate compounds or chemicals and is best done by a professional - see your dealer.

If the fiberglass should become damaged and need repair, contact your dealer or Everglades Customer Service for assistance in finding an authorized repair person to make the repairs.

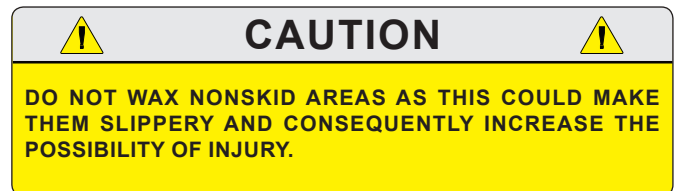

Stainless Steel Hardware

When using the boat in saltwater, the hardware should be washed with soap and water after each use. When your boat is used in a corrosive environment such as saltwater, water with a high sulfur content or polluted water, the stainless steel will periodically develop surface rust stains. This is perfectly normal under these conditions.

The following guidelines will help keep stainless steel looking good for many years.



- Clean stainless steel frequently (daily in salt or polluted environments) with mild soap and plenty of water. Any cleaner safe for use on glass is usually safe for stainless.
- Remove rust spots (especially around welds) immediately with a brass, silver or chrome cleaner. Irreversible pitting will develop under rust allowed to remain on stainless for any period of time.
- Remove rust stains on gelcoat. See dealer for recommended product.

Routine Maintenance

- Stainless Steel can normally be cleaned and protected by using a high quality boat or automotive wax or a commercial metal cleaner and protectant.

Never do the following on Stainless Steel.

- Do not use coarse abrasives like sandpaper or steel wool which may actually cause rusting.
- Do not use acids or bleaches which may etch the naturally occurring protective coating.
- Do not leave stainless steel in contact with iron, steel or other metals which cause contamination leading to rust or corrosion.



 **CAUTION** 

UNDER NO CIRCUMSTANCES SHOULD ANY ABRASIVE MATERIALS SUCH AS SANDPAPER, BRONZE WOOL OR STEEL WOOL BE USED ON STAINLESS STEEL. DAMAGE TO THE HARDWARE WILL RESULT.

Anodized Aluminum Surfaces

Anodized aluminum should be washed periodically with soap and water to keep it clean. If the boat is used in saltwater or polluted water, the aluminum should be washed with soap and water after each use. Saltwater allowed to remain on anodized aluminum will penetrate the anodized coating and attack the aluminum.

Hardtops, bimini tops or T-tops with canvas and/or fiberglass tops require special attention to the anodized aluminum just below the top. This area is subject to salt build up from salty condensation and sea spray. It is also frequently overlooked when the boat is washed and will not be rinsed by the rain. Consequently, the aluminum just below the top is more likely to become pitted than the exposed aluminum on the structure. Make sure the aluminum in this area is washed frequently with soap and water and rinsed thoroughly. Pay particular attention to places where the top material or lacing contact the frame. Once a month coat the entire frame with a metal protector made for anodized aluminum to protect against pitting and corrosion caused by the harsh effects of saltwater. Do not use automotive or boat wax designed for paint or gel coat on anodized aluminum. Wax can contaminate the aluminum and damage the anodized surface.

 **CAUTION** 

ONE DRAWBACK TO METAL PROTECTORS IS THAT THEY CAN MAKE THE METAL SLIPPERY. THEREFORE, THEY SHOULD BE NOT BE USED ON TOWER LADDERS, STEERING WHEELS AND OTHER AREAS WHERE A GOOD GRIP AND SURE FOOTING IS IMPORTANT.

Stains can be removed with a metal polish or fine polishing compound. To minimize corrosion, use only high quality stainless steel fasteners on aluminum fabrications. Isolate the fasteners from the aluminum by using fiber washers and caulking compound or Tef Gel to bed hardware and fasteners mounted to aluminum fabrications. If the anodized coating is badly scratched, it will require special attention and more frequent cleaning to the damaged area. With proper care, anodized aluminum will provide many years of service.

Powder Coated Aluminum

Powder coated aluminum should be washed periodically with soap and water to keep it clean. If the boat is used in saltwater or polluted water, the aluminum should be washed with soap and water after each use. Saltwater allowed to remain on powder coated aluminum will penetrate the coating and attack the aluminum, usually around fasteners and hardware mounted to the aluminum.

Pay special attention to the area just below the top. This area is subject to salt buildup from salty condensation and sea spray. It is also frequently overlooked when the boat is washed and will not be rinsed by the rain. Consequently, the powder coating near fasteners and hardware mounted just below the top is more likely to be attacked by the salt and become corroded than the exposed areas on the structure. Make sure the aluminum in this area is washed frequently with soap and water and rinsed thoroughly. Pay particular attention to places where the top material and lacing contact the frame.

Once a month check the entire frame for damaged powder coating and corrosion around fasteners and hardware. Nicked or badly scratched powder coating can be sanded and touched up with enamel paint. Corrosion will have to be sanded, then touched up with paint. Periodically applying automotive or boat wax to the powder coating will provide additional protection from the harsh effects of saltwater.

Routine Maintenance

We strongly recommend that you do not drill into or install any hardware to the aluminum frame. Poor maintenance or hardware and snaps mounted to the fabrication can void the warranty on the powder coated frame. If you do install hardware to the frame, the fasteners will require fiber washers and sealing with caulk or Tef Gel to isolate the fastener from the aluminum and reduce damage to the powder coating when the fastener is installed.

Always repair scratches, nicks and corroded areas in powder coating as soon as possible. Corrosion left unaddressed will lift the powder coating allowing moisture to travel between the powder coating and the aluminum causing corrosion to spread below the coating and damage the aluminum.

If excessive chipping and peeling occurs, it could be an indication of an electrical fault in the boat or aluminum fabrication. You should contact a qualified marine electrician to inspect your boat immediately and correct the problem if you suspect that your boat may have a fault in the aluminum frame. You should also contact your dealer or Everglades Customer Service.

Notice:

Boats that are towed behind larger vessels require special attention to the aluminum hardware. The salt spray, salty steam and chemicals in exhaust gases are particularly corrosive and will damage the surface of anodized or powder coated aluminum. It is imperative that the boat and the aluminum are cleaned thoroughly at the completion of each trip or at the end of each day on long cruises to reduce accelerated deterioration of the anodizing or powder coating and premature corrosion to the aluminum.

Notice:

You should contact Everglades Customer Service before making any modifications to aluminum fabrications. Unauthorized modifications can void the warranty.

Chrome Hardware

Use a good chrome cleaner and polish on all chrome hardware.

Acrylic Plastic Glass

Acrylic glass scratches easily. Never use a dry cloth or glass cleaning solutions on acrylic. Use a soft cloth and mild soap and water for routine

cleaning. Solvents and products containing ammonia can permanently damage acrylic plastic glass.

Fine scratches can be removed with a fine automotive clear coat polishing compound. A coat of automotive or boat wax is beneficial to protect the surface.

Do not use the following on acrylic glass:

Abrasive cleaners	Acetone
Solvents	Alcohol
Cleaners containing ammonia	Glass cleaners

Engines and Fuel

Proper engine maintenance is essential to the proper performance and reliability of your outboard engine. Maintenance schedules and procedures are outlined in your engine owner's manual. They should be followed exactly.

If the boat is used in saltwater, flush the cooling system after each daily use. To flush the system when the boat is out of the water, follow the procedure outlined in your engine owner's manual.

Proper engine operation requires a good supply of clean, dry fuel. Improper marina fuel storage techniques, limited boat usage, etc. can cause the fuel to become contaminated.

The age of fuel can affect engine performance. Chemical changes occur as the fuel ages that can cause deposits and reduce the octane rating of the fuel. Severely degraded fuel can damage the engine and boat fuel tank and lines. Therefore, if your boat is not being run enough to require at least one full tank of fresh fuel a month, a fuel additive should be added to protect it from degradation. Your dealer or the engine manufacturer can provide additional information on fuel degradation and fuel stabilizers recommended for your engine.

In many states, most gasoline is blended with ethanol alcohol. Ethanol is a strong solvent and can absorb water during periods of storage. You should refer to the engine operating manual for information regarding alcohol blended fuels and how it affects the operation of your marine engine.

13.2 Upholstery, Canvas & Enclosures

Vinyl Upholstery

The vinyl upholstery used on the seats, cushions, bolsters and for the headliner in some cabins, should be cleaned periodically with mild soap and water. Any stain, spill or soiling should be cleaned up promptly to prevent the possibility of permanent staining. When cleaning, always rub gently. Avoid using products containing ammonia, powdered abrasive cleaners, steel wool, ink, strong solvents, acetone and lacquer solvents or other harsh chemicals as they can cause permanent damage or shorten the life of vinyl. Never use steam heat, heat guns or hair dryers on vinyl.

Stronger cleaners, detergents and solvents may be effective in stain removal, but can cause either immediate damage or slow deterioration. Lotions, sun tan oil, waxes and polishes, etc., contain oils and dyes that can cause stiffening and staining of vinyls.

- Dry soil, dust and dirt - Remove with a soft cloth.
- Dried on dirt - Wash with a soft cloth dampened with water.
- Variations in surface gloss - Wipe with a water dampened soft cloth and allow to air dry.
- Stubborn dirt - Wash with a soft cloth dampened with Ivory Flakes® and water. Rinse with clean water.
- Stubborn spots and stains - Spray with either Fantastik Cleaner® or Tannery Car Care Cleaner® and rub with a soft cloth. Rinse with clean water.
- Liquid spills - Wipe immediately with a clean absorbent cloth. Rinse with clean water.
- Food grease and oily stains - Spray immediately using either Fantastik Cleaner® or Tannery Car Care Cleaner®, wiping with a soft cloth. Take care not to extend the area of contamination beyond its original boundary. Rinse with clean water.

Acrylic Canvas (Sunbrella)

Modern, bright colored canvas tops are usually fabricated from acrylic fabrics with the trade names like Sunbrella®, Argonaut®, etc. Acrylic fabrics look similar to cotton canvas but are much more durable and color fast.

Acrylic canvas can be cleaned by using Ivory Flakes, Ivory Liquid or another mild soap and water. Scrub lightly and rinse thoroughly to remove the soap. Do not use detergents, as they will deteriorate the waterproofing in the fabric. The underside can be brushed with a soft brush and sprayed with a disinfectant to prevent the accumulation of dirt and mildew. The top or accessories should never be folded or stored wet.

In fresh water areas, the top and curtains should be washed weekly. This is particularly important if the boat is stored near a highway, airport or in a large city. Residue from jet fuel, exhaust fumes and industrial pollution can shorten the life of tops and enclosures.

In saltwater areas, the top and curtains should be rinsed with fresh water after each use and at least weekly if it is stored outside. Saltwater attracts moisture and dirt can shorten the life of fabric tops and enclosures. The salt is also abrasive and can cause premature wear in the fabric and stitching.

After several years, the acrylic canvas may lose some of its ability to shed water. If this occurs, wash the fabric and let it dry thoroughly. Then treat the outside surface with a commercially available waterproofing designed for this purpose. Waterproofing is available in bulk at most canvas shops. One-gallon garden sprayers are excellent for applying waterproofing.

Notice:

Some leakage at the seams is normal and unavoidable with acrylic enclosures.

Laminated Vinyl Tops

Laminated vinyl top material is a lamination of two plies of specially formulated vinyl with an inner reinforcing core fabric. The most common trade name for this fabric is Weblon.® It is not unusual for the interior ply to be a different color than the exterior. There is a greater tendency for this type of fabric to leak at the seams than with acrylic or vinyl coated polyester. Paraffin wax that matches the top can be used to seal the seams if necessary.

Laminated vinyl fabrics should be cleaned periodically by using Ivory Flakes, Ivory Liquid or another mild soap and water. Scrub lightly and rinse thoroughly to remove the soap. Do not use detergents or harsh cleaners like bleach and ammonia. They will attack the vinyl in the fabric and shorten its life. The top or accessories should never be folded or stored wet.

In fresh water areas, the top and curtains should be washed weekly. This is particularly important if the

boat is stored near a highway, airport or in a large city. Residue from jet fuel, exhaust fumes and industrial pollution can shorten the life of tops and enclosures.

In saltwater areas, the top and curtains should be rinsed with fresh water after each use and at least weekly if it is stored outside. Saltwater attracts moisture and dirt can shorten the life of fabric tops and enclosures. The salt is also abrasive and can cause premature wear in the stitching.

Clear Curtains and Connectors

Side curtains and clear connectors can be cleaned with mild soap and water. They should not be allowed to become badly soiled. Dirt, oil, mildew and cleaning agents containing ammonia, will shorten the life of the vinyl that is used for clear curtains. After cleaning the curtains and allowing them to dry, apply a non-lemon furniture polish or an acrylic glass and clear plastic protector to extend the life of the curtains.

Vinyl curtains should be stored either rolled or flat, without folds or creases. Folding the curtains will make permanent creases that could cause the vinyl to crack.

Notice:

Do not use any polish containing lemon scents or lemon. The lemon juice will attack the vinyl and shorten its life.

Snaps should be lubricated periodically with Teflon or silicone grease or a lubricant designed for snaps. Zippers should be lubricated with silicone spray, paraffin or silicone stick.

Strataglass

Strataglass® is a special coated vinyl that could be used in the curtains for the hardtop enclosure. The coating protects the vinyl glass and resists scratching. Waxes and Plexiglas polishing compounds should not be used on strataglass as the protective coating prevents them from penetrating into the vinyl and they will build up on the surface. These products will create a hazy, greasy appearance that will affect the clarity of the strataglass. Products that repel water, like Rainex®, should not be used as they will not take well to the surface and could appear spotty and may also yellow or dull the Strataglass over time.

Strataglass can be cleaned by rinsing off dirt or salt deposits with fresh water, then washing with a clean cloth and mild soap. Chamois dry to re-

move water spots and improve clarity. If a polish is accidentally used, use Windex® or its equivalent to remove it. While window cleaners will destroy the standard vinyl normally used in side curtains and clear connectors, it will not harm strataglass. Always roll down the curtains and snap in place at the end of each day so the curtains will maintain their shape and to minimize fold distortions.

Depending upon usage, it is recommended that an occasional application of Aquatech Strataglass Cleaner be done. Treat this like a polish, as opposed to a cleaner - wash and dry curtains first, then apply Aquatech Strataglass Cleaner, actually buffing the surface to a beautiful sheen. This is not just a wipe on/ wipe off product...it needs to be buffed to perform.

Remember, the coating on strataglass is scratch resistant and not scratch proof. Always handle the curtains with care and never roll up curtains that are salty or dirty. If you have any questions about the clear curtains used on your boat, please contact the Everglades Customer Service Department.

Hardtop enclosures must be removed when trailering. Canvas enclosures are not designed to withstand the extreme wind pressure encountered while trailering and will be damaged. Always remove and properly store the enclosure before trailering your boat.

13.3 Interior

The cabin or head interior can be cleaned just like you would clean a home interior. To preserve woodwork, use teak oil. To maintain carpeting, use a vacuum cleaner. Because air and sunlight are very good cleansers, periodically put cushions, sleeping bags, etc. on deck, in the sun and fresh air, to dry and air out. If cushions or equipment get wet with saltwater, remove and use clean, fresh water to rinse off the salt crystals. Salt retains moisture and will cause damage. Dry thoroughly and reinstall.

Vinyl headliner material should be cleaned periodically as explained in the previous section. Avoid using products containing ammonia, bleach or harsh chemicals as they can shorten the life of vinyl. Fiberglass headliners should be wiped down with a damp towel as necessary to remove dust and dirt.

Routine Maintenance

If you leave the boat for a long period of time, put all cushions on their sides, open all interior cabin and locker doors and hang a commercially available mildew protector in the cabin.

Notice:

Always read the label carefully on mildew protectors. Remove the protector and allow the cabin to ventilate completely before using the cabin.

Counter Tops - Faux Granite

A mild liquid detergent and water or disinfectant cleaners will remove most dirt and stains from Faux Granite. Rinse with a clean cloth moistened with fresh water. Wipe dry with a clean cloth.

Never use granite cleaners, bleaches, ammonia, household cleaners, polishes or scouring pads. Harsh cleaners and scouring pads will damage the polymer surface of Faux Granite.

In most cases, Faux Granite can be repaired if accidentally damaged. Small scratches that do not penetrate the coating can be repaired using an automotive buffing compound. Deep scratches and heavy damage require a professional repair. Contact your dealer or a counter top repair professional for assistance in repairing deep scratches or other damage on your counter tops.

Interior Woodwork

Oiled and varnished woodwork or laminated, simulated wood can be cleaned with a damp cloth. For heavy duty cleaning, use a mixture of water and Murphy's Oil Soap or a solution of 10% white vinegar and water to clean the wood and wipe it dry with a clean towel. Apply a furniture polish to add luster and help to preserve the finish.

13.4 Bilge, Pumps & Components

To keep the bilge clean and fresh, it is recommended that you use a commercial bilge cleaner on a regular basis. Follow the directions carefully. All exposed pumps and metal components in the bilge should be sprayed periodically with a protector to reduce the corrosive effects of the high humidity always present in these areas.

Periodically check the bilge pumps and alarms for proper operation and clean debris from the strainers and float switches. Inspect all hoses, clamps and thru-hulls for leaks and tightness on a regular

basis. Operate all thru-hull valves at least once a month to keep them operating properly.

Frequently test the automatic switches for the bilge pumps and alarms for proper operation.

Windshield Hydraulic System

The hydraulic pump operates at very high pressures and has specific maintenance requirements. You should perform all recommended maintenance according to the pump manufacturers' specifications.

Inspection and Routine Maintenance

- Check the hydraulic oil level frequently or immediately following the repair of a leaking fitting or any hydraulic system service. Use only hydraulic oil meeting the pump manufacturer's specifications. Refer to the pump manufacturer's operating and information manual for information on the operation and maintenance of the hydraulic system and oil specifications.

Notice:

Always check the hydraulic oil level with the windshield down to provide an accurate oil level reading and avoid overfilling the reservoir.

- Inspect all hoses, fittings, valves and seals for leaks and proper operation monthly.
- Periodically inspect all electrical connections, paying close attention to the heavy electrical wires, to make sure the connectors are corrosion free and tight. Corroded terminals should be thoroughly cleaned with sandpaper or replaced, tightened securely and sprayed with a metal and electrical protector. Coating the connectors with dielectric, Teflon or silicone grease will protect them and reduce future corrosion.

13.5 Drainage System

It is essential that the following items be done periodically to maintain proper drainage of your boat:

- Clean the cockpit drains with a hose to remove debris that can block water drainage.
- Clean the hardtop leg drain holes. This is especially important just before winter lay-up.
- Flush all gravity drains with fresh water to keep them clean and free flowing.

Routine Maintenance

- Operate the thru-hull valves once a month and service as required.
- Run all overboard pumps briefly at least once a month to keep them operating properly.

Notice:
All drains and pumps must be properly winterized before winter lay-up.

SEASONAL MAINTENANCE

14.1 Storage & Lay-up

Before Hauling:

- Pump out the head holding tank. Flush the holding tank using clean water, soap and a deodorizer. Pump out the cleaning solution.
- The fuel tank should be left nearly full to reduce condensation that can accumulate in the tank. Allow enough room in each tank for the fuel to expand without leaking out the vents. Moisture from condensation in the fuel tank can reach such concentrations that it becomes heavy enough to settle out of the fuel to the bottom of the tank. Since fuel pickup tubes are located near the bottom of the tank, this accumulated moisture can cause the engine to run poorly or not at all after extended storage.



Chemical changes also occur as the gasoline ages that can cause deposits and varnish in the fuel system as well as reduce the octane rating of the fuel. Severely degraded fuel can damage the engine and boat fuel tank and lines. Therefore, if your boat is not being run enough to require at least one full tank of fresh fuel a month or during winter storage, a fuel stabilizer should be added to the gasoline to help protect the fuel system from these problems. Operate the boat for at least 15 minutes after adding the stabilizer to allow the treated fuel to reach the engine. Yamaha recommends using Yamaha Fuel Conditioner and Stabilizer for their engines.

Your dealer or the engine manufacturer can provide additional information on fuel degradation and fuel stabilizers recommended for your engines. For more recommendations for your specific area, check with your local Everglades dealer.

- Drain water from the fresh water system.
- Consult the engine owner's manual for detailed information on preparing the engine for storage.

Lifting

It is essential that care be used when lifting your boat. Make sure the spreader bar at each sling is at least as long as the distance across the widest point of the boat that the sling will surround. Put the slings in position. Sling labels on the gunnels just above the rubrail identify the correct position for the lifting slings. The fore and aft slings should be tied together to prevent the slings from sliding on the hull.

 **CAUTION** 

BOATS CAN BE DAMAGED FROM IMPROPER LIFTING AND TRANSPORTING WITH FORK LIFTS. CARE AND CAUTION MUST BE EXERCISED WHEN TRANSPORTING A BOAT WITH A FORK LIFT. NEVER HOIST THE BOAT WITH A SUBSTANTIAL AMOUNT OF WATER IN THE BILGE.

SEVERE GEL COAT CRACKING OR MORE SERIOUS HULL DAMAGE CAN OCCUR DURING HAULING AND LAUNCHING IF PRESSURE IS CREATED ON THE GUNWALES (SHEER) BY THE SLINGS. FLAT, WIDE BELTING SLINGS AND SPREADERS LONG ENOUGH TO KEEP PRESSURE FROM THE GUNWALES ARE ESSENTIAL. DO NOT ALLOW ANYONE TO HAUL YOUR BOAT WHEN THE SPREADERS ON THE LIFT ARE NOT WIDE ENOUGH TO TAKE THE PRESSURE OFF THE GUNWALES.

Supporting The Boat For Storage

A trailer, elevating lift, well-made cradle or proper blocking is the best support for your boat during storage.

When storing the boat on a trailer for a long period:

- Make sure the trailer is large enough to properly support your boat and that it is rated to support the weight.
- Make sure the trailer is on a level surface and the bow is high enough so that water will drain from the bilge and cockpit.
- Make sure the engine is in the down position.

Seasonal Maintenance

- The trailer must properly support the hull. The bunks and rollers should match the bottom of the hull and should not be putting pressure on the lifting strakes.
- Make sure the hitch is properly supported.
- Check the tires once each season. Add enough air for the correct amount of inflation for the tires as necessary.
- Use at least two heavy duty jacks on each side of the hull and make sure the boat is level from side to side. The jacks must be on a solid surface like packed gravel, concrete or pavement. All of the supports must be set up properly to prevent the boat from shifting while it is in storage.

Notice:

Read the owner's manual for the trailer for the correct amount of inflation for the tires.

When storing the boat on a lift or cradle:

- The cradle must be specifically for boat storage.
- Make sure the cradle or lift is well supported with the bow high enough to provide proper drainage of the bilge and cockpit.
- Make sure the engine is in the down position.
- The cradle or lift must be in the proper fore and aft position to properly support the hull. When the cradle or lift is in the correct location, the bunks should match the bottom of hull and should not be putting pressure on the lifting strakes.



CAUTION



BOATS HAVE BEEN DAMAGED BY TRAILERS, LIFTS AND CRADLES THAT DON'T PROPERLY SUPPORT THE HULL. ALWAYS MAKE SURE THE BUNKS AND ROLLERS ARE ADJUSTED SO THEY ARE NOT PUTTING PRESSURE ON THE LIFTING STRAKES AND ARE PROVIDING ENOUGH SUPPORT FOR THE HULL. HULL DAMAGE RESULTING FROM IMPROPER CRADLE OR TRAILER SUPPORT IS NOT COVERED BY THE EVERGLADES WARRANTY.

When supporting the boat with blocking:

- Make sure the boat is blocked on a level surface and the bow is high enough so that water will drain from the bilge and cockpit.
- Make sure the keel is supported with large, solid wood blocks in at least three points.

Preparing The Boat For Storage:

- Remove the bilge drain plug, if installed.
- Thoroughly wash the fiberglass exterior, especially the antifouling portion of the bottom. Remove as much marine growth as possible. Lightly wax the exterior fiberglass components.
- Remove all oxidation from the exterior hardware and apply a light film of moisture displacing lubricant, wax or a metal protector.
- Remove propellers and grease the propeller shafts using light waterproof grease.
- Remove the batteries and store in a cool place. Clean using clear, clean water. Be sure the batteries have sufficient water and clean terminals. Keep the batteries charged and safe from freezing throughout the storage period.

Notice:

Refer to the Electrical System chapter, for information on the maintenance of the AC and DC electrical systems.

- Coat all faucets and exposed electrical components in the cabin and cockpit with a protecting oil.
- Clean out, totally drain and completely dry the fish boxes, coolers, sinks and baitwells.
- Thoroughly clean the interior of the boat. Vacuum all carpets and dry clean drapes and upholstery.
- Remove cushions and open as many locker doors as possible. Leaving as many of these areas open as possible will improve the boat's ventilation during the storage period.

Notice:

It is recommended that a mildew preventer be hung in the head compartment before it is closed for storage.

- Clean the exterior upholstery with a good vinyl cleaner and dry thoroughly. Spray the weather covers and boat upholstery with a spray disinfectant. Enclosed areas such as the shower basin, storage locker areas, etc. should also be sprayed with this disinfectant.

14.2 Winterizing Fresh Water System

The entire fresh water system must be completely drained. Disconnect all hoses, check valves, etc. and blow all the water from the system. Make sure the filters and fresh water tank are completely drained. Use only very low air pressure when doing this to prevent possible system damage. Because of the check valve mechanism built in the pump, blowing the lines will not remove the water from the fresh water pump. Remove the inlet and outlet hoses on the pump. Turn the pump on and allow it to pump out any remaining water... about a cupful.

A recommended alternative to the above-mentioned procedure is the use of commercially available non toxic, fresh water system antifreeze. After draining the fresh water tank, lines and filters, pour the antifreeze mixture into the fresh water tank, prime and operate the pump until the mixture flows from all fresh water faucets. Be sure to open all water faucets, including the fresh water washdown hose. Make sure antifreeze has flowed through all of the fresh water drains.

For additional information refer to the Fresh Water System and Drainage Systems chapters.

Raw Water System

Completely drain the raw water systems including the sea strainers in the stern bilge. Disconnect all hoses and blow the water from the system. Use only very low air pressure when doing this to prevent possible system damage. Because of the check valve mechanism built in the raw water washdown pump, blowing the lines will not remove the water from the raw water pump. Remove the inlet and outlet hoses on the pump. Turn the pump on and allow it to pump out any remaining water....about a cupful.

A recommended alternative to the above-mentioned procedure is the use of commercially available nontoxic, potable water system antifreeze. If potable water antifreeze is used, pour the mixture

into a pail and put the raw water intake lines into the solution. Run the pumps one at a time until the antifreeze solution is visible at all raw water faucets and discharge fittings and drains. Be sure antifreeze has flowed through all of the raw water drains.

Make sure to run the fish box pumps until all the water is removed from the fish boxes and the pump. Then pour potable water antifreeze in each fish box and activate the pumps until antifreeze is visible at the discharge thru-hull fittings. To avoid damage to the pump, be careful not to run the pump dry for more than a few seconds.

Make sure all water is removed from the livewell and that the drain is clear and free flowing. Install the livewell drain plug, pour potable water antifreeze in livewell and activate the recirculation pump until antifreeze is visible at the discharge fitting. Remove the drain plug and wipe down the inside of the baitwell.

Refer to the Raw Water System chapter for additional information on the raw water system.

Marine Toilet

The marine toilet must be properly winterized by following the manufacturer's winterizing instructions in the marine toilet owner's manual. Drain the intake and discharge hoses completely using low air pressure if necessary. The head holding tank and overboard discharge pump must be pumped dry and one gallon of potable water antifreeze poured into the tank through the deck waste pump out fitting. After the antifreeze has been added to the holding tank, open the overboard discharge valve and activate the overboard macerator pump until the antifreeze solution is visible at the discharge thru-hull.

Notice:

Make sure you follow the marine toilet manufacturer's winterizing instructions exactly.

Portable Marine Toilet

The portable head must be properly winterized by following the manufacturer's winterizing instructions in the portable head owner's manual.

Notice:

Make sure you follow the marine toilet manufacturer's winterizing instructions exactly.

Bilge

Coat all metal components, wire busses and connector plugs in the bilge with a protecting oil. It is also important to protect all strainers, seacocks and steering components. The bilge pumps and bilge pump lines must be completely free of water and dried out when the boat is laid-up for the winter in climates where freezing occurs. Compartments in the bilge that will not drain completely should be pumped out and then sponged until completely free of water. Dry the hull bilge and self-bailing cockpit troughs. Water freezing in these areas could cause damage.

Outboard Engine

The engine should be flushed with fresh water for at least 15 minutes prior to winter storage. This will remove salt, sand and other contaminants that can damage the engine. It is also important to "Fog" the cylinders, change the gear oil, fill the oil tanks (2-cycle engines) or change the oil in 4-cycle engines, coat the engine with a protector, wax the exterior and properly store and charge the batteries. You should refer to the engine owner's manual or contact your dealer for specific instructions on winterizing your engines.

Notice:

Properly winterize the engine and fuel system by following the engine manufacturer's winterizing procedures located in your engine owner's manuals or contact an Everglades dealer.

Hardtop



It is imperative that all drain holes in the legs are open and that the legs are completely free of water. Remove the canvas and thoroughly clean and store in a safe, dry place. Remove all electronics. Coat all wire connectors and bus bars in the helm compartment with a protecting oil.

Clean the aluminum frame with soap and water and dry thoroughly. Apply an aluminum metal protector to the entire frame on anodized aluminum to reduce corrosion and pitting. Apply an automotive or boat wax to powder coated aluminum to protect it during storage periods.

Special Notes Prior To Winter Storage

If the boat will be in outside storage, properly support a storage cover and secure it over the boat. It is best to have a frame built over the boat to support the canvas. It should be a few inches wider than the boat so the canvas will clear the rails and allow passage of air. If this cover is fastened too tightly there will be inadequate ventilation and this can lead to mildew, moisture accumulation, etc. It is essential to fasten the canvas down securely so that the wind cannot remove it or cause chafing of the hull superstructure. Do not store the boat in a damp storage enclosure. Excessive dampness can cause electrical problems, corrosion and excessive mildew.

Whenever possible, do not use the bimini top or convertible top canvas in place of the winter storage cover. The life of these canvases may be significantly shortened if exposed to harsh weather elements for long periods.



	CAUTION	
PLACING AN ELECTRIC OR FUEL BURNING HEATING UNIT IN THE BILGE AREA CAN BE POTENTIALLY HAZARDOUS AND IS NOT RECOMMENDED.		

Proper storage is very important to prevent serious damage to the boat. If the boat is to be stored indoors, make sure the building has enough ventilation. It is very important that there is enough ventilation both inside the boat and around the boat.

Notice:



If the boat is to be stored indoors or outdoors, open all interior drawers, clothes lockers, cabinets and doors a little. If possible, remove the upholstery, mattresses, clothing and rugs. Then hang a commercially available mildew protector in the interior compartments.

14.3 Recommissioning

	WARNING	
DO NOT OPERATE THE BOAT UNLESS IT IS COMPLETELY ASSEMBLED. KEEP ALL FASTENERS TIGHT. KEEP ADJUSTMENTS ACCORDING TO SPECIFICATIONS.		

Notice:

It is important and recommended that the fitting out procedure for the marine gear be done by a qualified service person. Read the engine owner's manual for the recommended procedure.

	CAUTION	
BEFORE LAUNCHING THE BOAT, MAKE SURE THE HULL DRAIN PLUG IS INSTALLED.		

Reactivating The Boat After Storage:

- Charge and install the batteries.
- Install the drain plug in the hull.
- Check the engine for damage and follow the manufacturer's instructions for recommissioning.
- Check the mounting bolts for the engine to make sure they are tight.

- Perform all routine maintenance.
- Check all hose clamps for tightness.
- Pump the antifreeze from the fresh and raw water systems and flush several times with fresh water.
- Check and lubricate the steering system.
- Clean and wash the boat.
- Install all upholstery, cushions and canvas.

After Launching:

- Carefully check all water systems and the engine bolts for leaks. Operate each system one at a time checking for leaks and proper operation.
- Check the bilge pump manual and automatic switches.
- When the engine starts, check the cooling system port below the engine cowling for a strong stream of water. This ensures that the cooling pump is operating.
- Carefully monitor the gauges and check for leakage and abnormal noises.
- Operate the boat at slow speeds until the engine temperature stabilizes and all systems are operating normally.

NOTES

SCHEMATICS

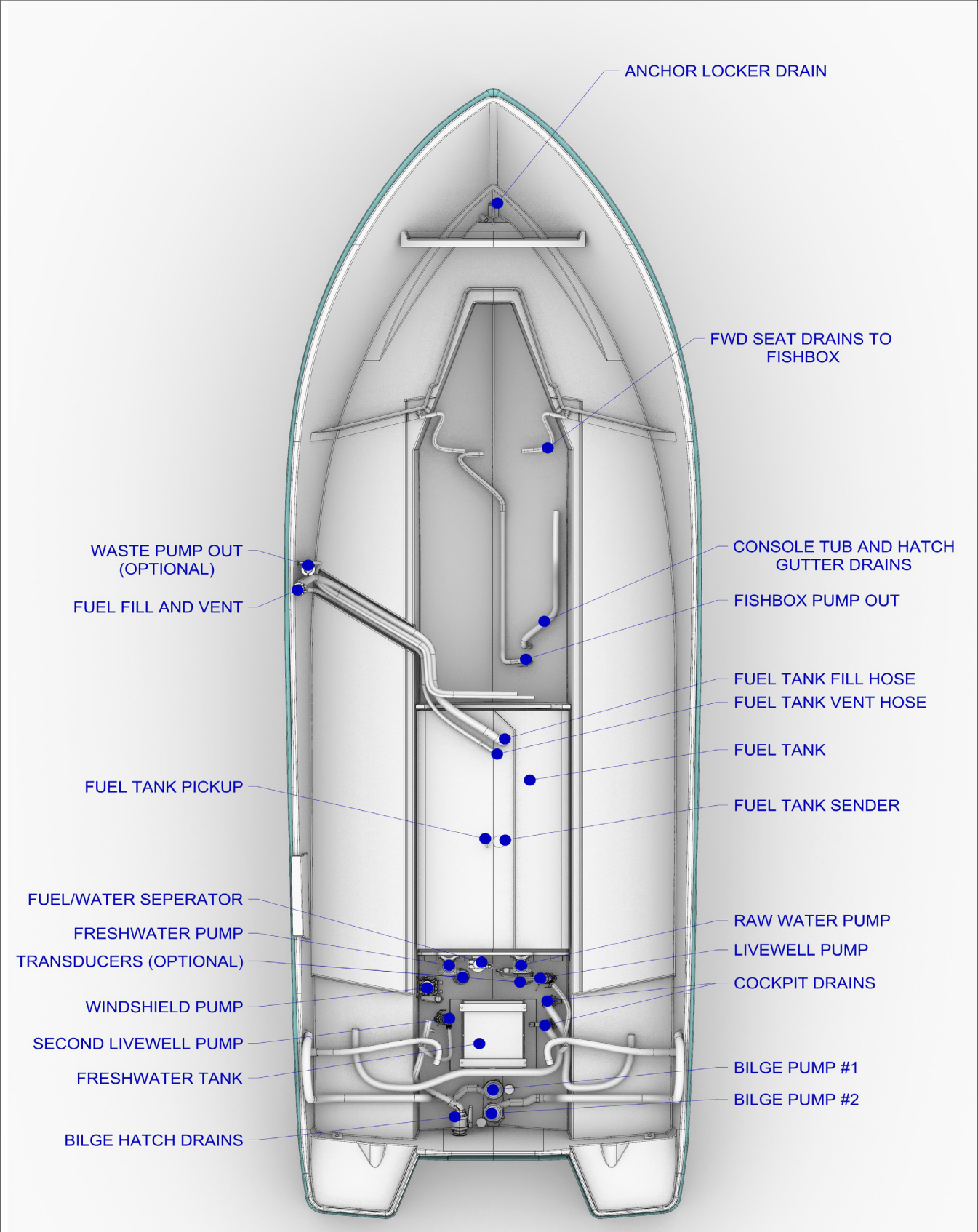

Drainage System

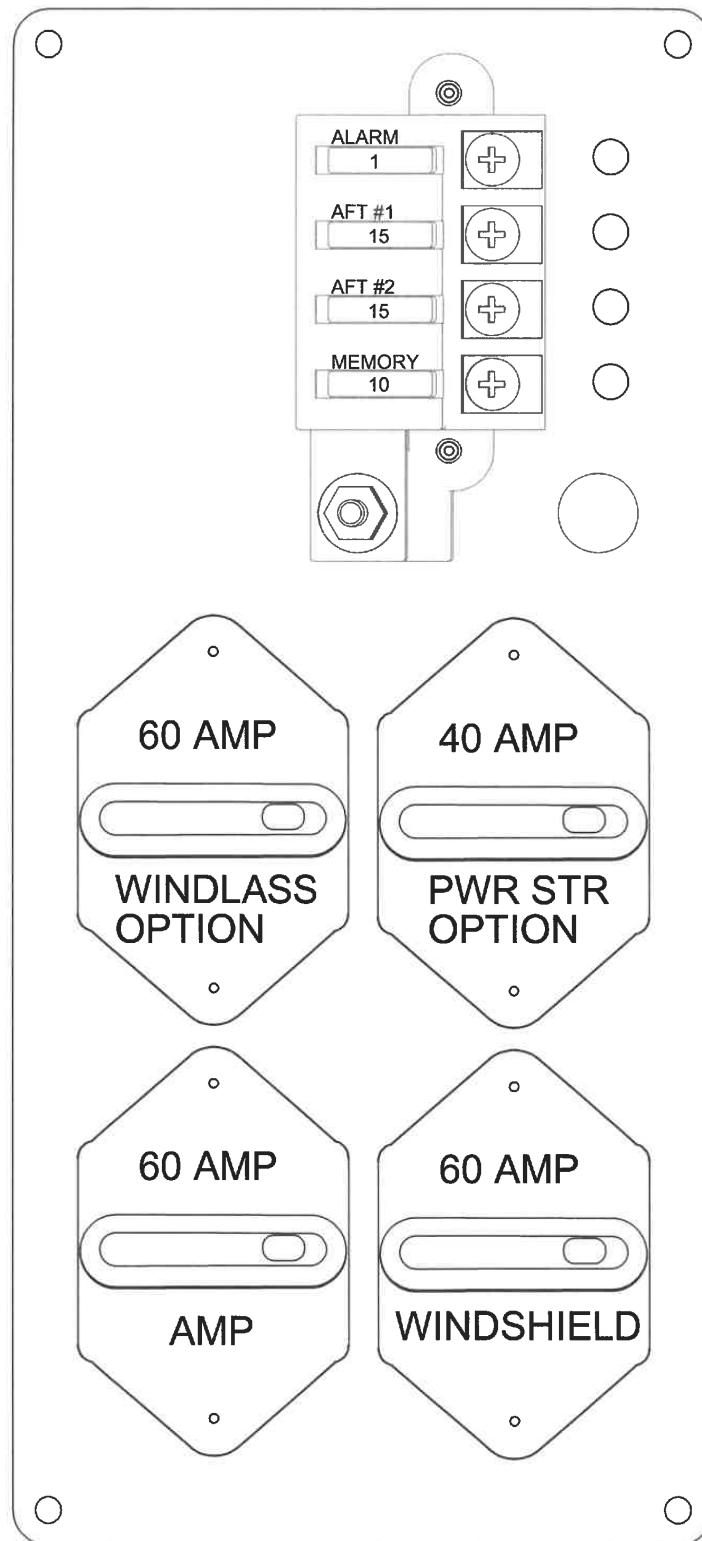

Battery Board Fuse Location

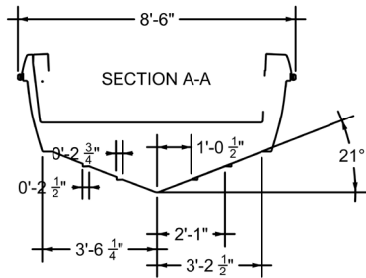
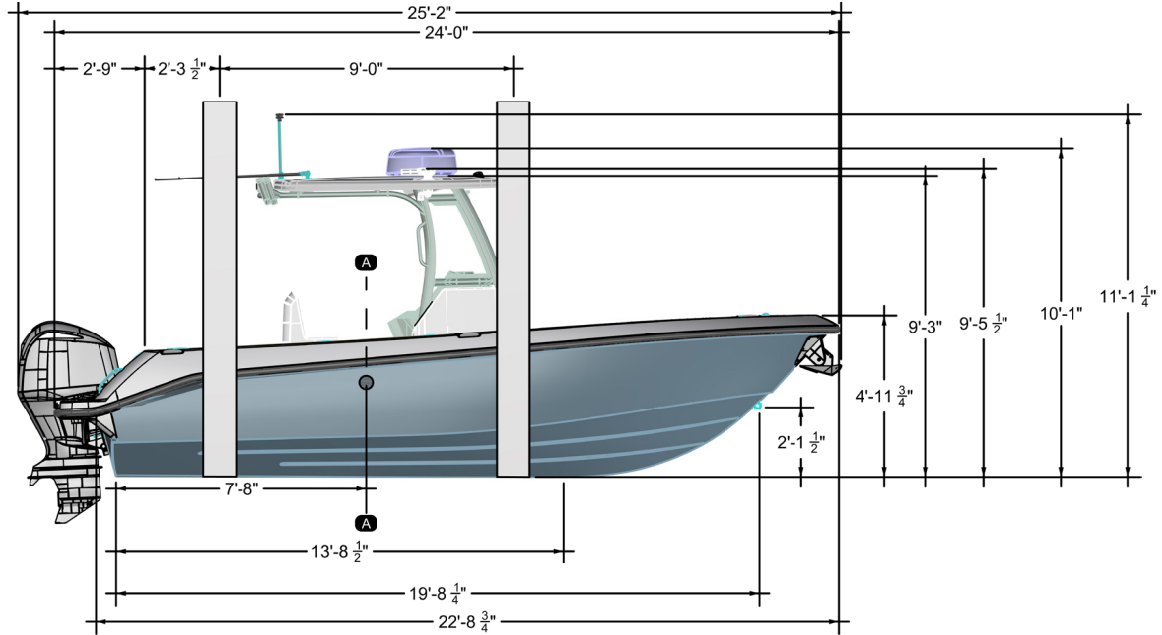

NOTES:

- 1) THE VESSEL IS SHOWN WITH 300HP YAMAHA V6
- 2) THE DRY WEIGHT WITH THE ENGINE IS 5,600 LB
- 3) THE VESSEL WEIGHT WITH FULL FUEL & WATER, INCLUDING OPTIONS IS 6,400 LB
- 4) ACTUAL VESSEL WEIGHTS DO NOT INCLUDE OWNER STORES & CAN VARY FROM HULL TO HULL.
- 4) THE TRANSOM DEADRISE IS 19 DEGREES
- 5) THE VESSEL IS SHOWN WITH OPTIONAL EQUIPMENT

Graving Plan

NOTES

OCCUPANT SEATING LOCATIONS

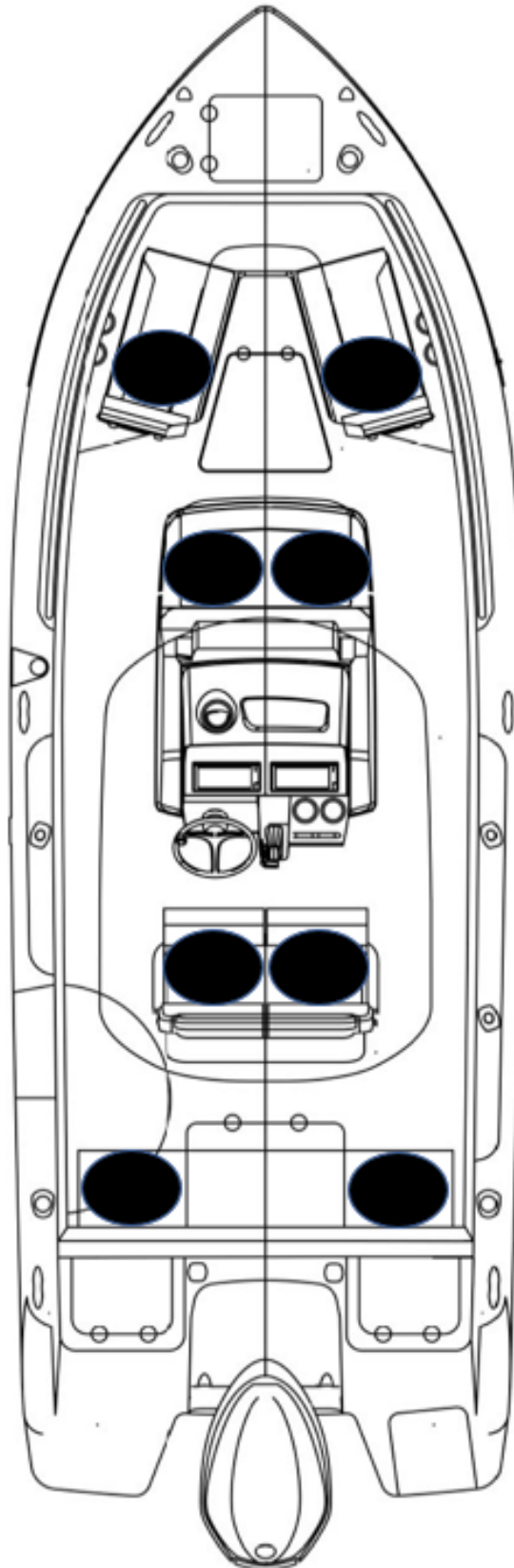

NOTES

GLOSSARY OF TERMS

Aft: In, near or toward the stern of a boat.

Aground: A boat stuck on the bottom.

Amidships: In or toward the part of a boat midway between the bow and stern.

Anchor: A specially shaped heavy metal device designed to dig efficiently into the bottom under a body of water and hold a boat in place.

Anchorage: An area specifically designated by governmental authorities in which boats may anchor.

Ashore: On shore.

Astern: Behind the boat, to move backwards.

Athwartship: At right angles to the center line of the boat.

Barnacles: Small, hard-shelled marine animals which are found in salt water attached to pilings, docks and bottoms of boats.

Beam: The breadth of a boat usually measured at its widest part.

Bearing: The direction of an object from the boat, either relative to the boat's direction or to compass degrees.

Berth: A bunk or a bed on a boat.

Bilge: The bottom of the boat below the flooring.

Bilge Pump: A pump that removes water that collects in the bilge.

Boarding: Entering or climbing into a boat.

Boarding Ladder: Set of steps temporarily fitted over the side of a boat to assist persons coming aboard.

Boat Hook: Short shaft of wood or metal with a hook fitting at one end shaped to aid in extending one's reach from the side of the boat.

Bow: The front end of a boat's hull

Bow Line: A line that leads forward from the bow of the boat.

Bow Rail: Knee high rails of solid tubing to aid in preventing people from falling overboard.

Bridge: The area from which a boat is steered and controlled.

Bridge Deck: A deck forward and usually above the cockpit deck.

Broach: When the boat is sideways to the seas and in danger of capsizing; a very dangerous situation that should be avoided.

Bulkhead: Vertical partition or wall separating compartments of a boat.

Cabin: Enclosed superstructure above the main deck level.

Capsize: When a boat lays on its side or turns over.

Chock: A deck fitting, usually of metal, with inward curving arms through which mooring or anchor lines are passed so as to lead them in the proper direction both on board and off the boat.

Cleat: A deck fitting, usually of metal with projecting arms used for securing anchor and mooring lines.

Closed Cooling System: A separate supply of fresh water that is used to cool the engine and circulates only within the engine.

Coaming: A vertical piece around the edges of cockpit, hatches, etc. to stop water on deck from running below.

Cockpit: An open space, usually in the aft deck, outside of the cabin.

Companionway: Opening in the deck of a boat to provide access below.

Compartment: The interior of a boat divided off by bulkheads.

Cradle: A framework designed to support a boat as she is hauled out or stored.

Cutlass Bearing: A rubber bearing in the strut that supports the propeller shaft.

Glossary of Terms

Deck: The floor-like platform of a boat that covers the hull.

Displacement: The volume of water displaced by the hull. The displacement weight is the weight of this volume of water.

Draft: The depth of water a boat needs to float.

Dry Rot: A fungus attack on wood areas.

Dry-dock: A dock that can be pumped dry during boat construction or repair.

Electrical Ground: A connection between an electrical connector and the earth.

Engine Beds: Sturdy structural members running fore and aft on which the inboard engines are mounted.

EPIRB: Emergency Position Indicating Radio Beacon. Operates as a part of a worldwide satellite distress system.

Even Keel: When a boat floats properly as designed.

Fathom: A measure of depth. One Fathom = 6 feet.

Fender: A soft object of rubber or plastic used to protect the topsides from scarring and rubbing against a dock or another vessel.

Fend off: To push or hold the boat off from the dock or another boat.

Flying Bridge: A control station above the level of the deck or cabin.

Flukes: The broad portions of an anchor which dig into the ground.

Fore: Applies to the forward portions of a boat near the bow.

Foundering: When a boat fills with water and sinks.

Freeboard: The height from the waterline to the lowest part of the deck.

Galley: The kitchen of a boat.

Grab Rail: Hand-hold fittings mounted on cabin tops or sides for personal safety when moving around the boat, both on deck and below.

Ground Tackle: A general term including anchors, lines and other gear used in anchoring.

Grounds: A boat touches the bottom.

Gunwale: The upper edge of a boat's side.

Hand Rail: Rail mounted on the boat, for grabbing with your hand, to steady you while walking about the boat.

Harbor: An anchorage which provides reasonably good protection for a boat, with shelter from wind and sea.

Hatch: An opening in the deck with a door or lid to allow for access down into a compartment of a boat.

Head: A toilet on a boat.

Heat Exchanger: Used to transfer the heat that is picked up by the closed cooling system to the raw cooling water.

Helm: The steering and control area of a boat.

Hull: The part of the boat from the deck down.

Inboard: A boat with the engine mounted within the hull of the boat. Also refers to the center of the boat away from the sides.

Inboard/outboard: Also stern drive or I/O. A boat with an inboard engine attached to an outboard drive unit.

Keel: A plate or timber plate running lengthwise along the center of the bottom of a boat.

Knot: Unit of speed indicating nautical miles per hour. 1 knot = 1 nautical mile per hour (1.15 miles per hour). A nautical mile is equal to one minute of latitude: 6076 feet. Knots times 1.15 equals miles per hour. Miles per hour times .87 equals knots.

Lay-up: To decommission a boat for the winter (usually in northern climates).

Leeward: The direction toward which the wind is blowing.

Glossary of Terms

Length On The Waterline (l.w.l.): A length measurement of a boat at the waterline from the stern to where the hull breaks the water near the bow.

Limber Hole: A passage cut into the lower edges of floors and frames next to the keel to allow bilge water to flow to the lowest point of the hull where it can be pumped overboard.

Line: The term used to describe a rope when it is on a boat.

Lists: A boat that inclines to port or starboard while afloat.

L.O.A.: Boat length overall.

Locker: A closet, chest or box aboard a boat.

Loran: An electronic navigational instrument which monitors the boat's position using signals emitted from pairs of transmitting stations.

Lunch hook: A small light weight anchor typically used instead of the working anchor. Normally used in calm waters with the boat attended.

Midships: The center of the boat.

Marina: A protected facility primarily for recreational small craft.

Marine Ways or Railways: Inclined planes at the water's edge onto which boats are hauled.

Moored: A boat secured with cables, lines or anchors.

Mooring: An anchor permanently embedded in the bottom of a harbor that is used to secure a boat.

Nautical Mile: A unit of measure equal to one minute of latitude. (6076 feet)

Nun Buoy: A red or red-striped buoy of conical shape.

Outboard: A boat designed for an engine to be mounted on the transom. Also a term that refers to objects away from the center line or beyond the hull sides of a boat.

Pad Eye: A deck fitting consisting of a metal eye permanently secured to the boat.

Pier: A structure which projects out from the shoreline.

Pile or Piling: A long column driven into the bottom to which a boat can be tied.

Pitching: The fore and aft rocking motion of a boat as the bow rises and falls.

Pitch: The measure of the angle of a propeller blade. Refers to the theoretical distance the boat travels with each revolution of the propeller.

P.F.D: Personal Flotation Device.

Port: The left side of the boat when facing the bow.

Porthole (port): The opening in the side of a boat to allow the admittance of light and air.

Propeller: A device having two or more blades that is attached to the engine and used for propelling a boat.

Propeller Shaft: Shaft which runs from the back of the engine gear box, aft, through the stuffing box, shaft log, struts and onto which the propeller is attached.

Pyrotechnic Distress Signals: Distress signals that resemble the brilliant display of flares or fireworks.

Raw Water Cooled: Refers to an engine cooling system that draws seawater in through a hull fitting or engine drive unit, circulates the water in the engine and then discharges it overboard.

Reduction Gear: Often combined with the reverse gear so that the propeller turns at a slower rate than the engine.

Reverse Gear: Changes the direction of rotation of the propeller to provide thrust in the opposite direction for stopping the boat or giving it sternway.

Roll: A boat's sideways rotational motion in rough water.

Rope Locker: A locker, usually located in the bow of a boat, used for stowing the anchor line or chain.

Rubrail: Railing (often rubber or hard plastic) that runs along the boat's sheer to protect the hull when coming alongside docks, piers or other boats.

Rudder: A moveable flat surface that is attached vertically at or near the stern for steering.

Sea anchor: An anchor that does not touch the bottom. Provides drag to hold the bow in the most favorable position in heavy seas.

Glossary of Terms

Scupper: An opening in the hull side or transom of the boat through which water on deck or in the cockpit is drained overboard.

Seacock: Safety valves installed just inside the thru-hull fittings and ahead of the piping or hose running from the fittings.

Shaft Log: Pipe through which the propeller shaft passes.

Sheer: The uppermost edge of the hull.

Sling: A strap which will hold the boat securely while being lifted, lowered or carried.

Slip: A boat's berth between two pilings or piers.

Sole: The deck of a cockpit or interior cabin.

Spring Line: A line that leads from the bow aft or from the stern forward to prevent the boat from moving ahead or astern.

Starboard: The right side of a boat when facing the bow.

Steerageway: Sufficient speed to keep the boat responding to the rudder or drive unit.

Stem: The vertical portion of the hull at the bow.

Stern: The rear end of a boat.

Stow: To pack away neatly.

Stringer: Longitudinal members fastened inside the hull for additional structural strength.

Strut: Mounted to the hull which supports the propeller shaft in place.

Strut Bearing: See "cutlass bearing."

Stuffing Box: Prevents water from entering at the point where the propeller shaft passes through the shaft log.

Superstructure: Something built above the main deck level.

Swamps: When a boat fills with water from over the side.

Swimming Ladder: Much the same as the boarding ladder except that it extends down into the water.

Taffrail: Rail around the rear of the cockpit.

Thru-hull: A fitting used to pass fluids (usually water) through the hull surface, either above or below the waterline.

Topsides: The side skin of a boat between the waterline or chine and deck.

Transom: A flat stern at right angles to the keel.

Travel Lift: A machine used at boat yards to hoist boats out of and back into the water.

Trim: Refers to the boat's angle or the way it is balanced.

Trough: The area of water between the crests of waves and parallel to them.

Twin-Screw Craft: A boat with two propellers on two separate shafts.

Underway: When a boat moves through the water.

Wake: Disrupted water that a boat leaves astern as a result of its motion.

Wash: The flow of water that results from the action of the propeller or propellers.

Waterline: The plane of a boat where the surface of the water touches the hull when it is afloat on even keel.

Watertight Bulkhead: Bulkheads secured so tightly so as not to let water pass.

Wharf: A structure generally parallel to the shore.

Working Anchor: An anchor carried on a boat for most normal uses. Refers to the anchor used in typical anchoring situations.

Windlass: A winch used to raise and lower the anchor.

Windward: Toward the direction from which the wind is coming.

Yacht Basin: A protected facility primarily for recreational small craft.

Yaw: When a boat runs off her course to either side.

Appendix E:

DEPARTMENT OF TRANSPORTATION U.S. COAST GUARD CG-3865 (Rev. 9/95)		BOATING ACCIDENT REPORT		FORM APPROVED OMB NO. 2115-0010		
STATE ASSIGNED CASE NO. _____						
THE OPERATOR/OWNER OF A VESSEL USED FOR RECREATIONAL PURPOSES IS REQUIRED TO FILE A REPORT IN WRITING WHENEVER AN ACCIDENT RESULTS IN: LOSS OF LIFE OR DISAPPEARANCE FROM A VESSEL; AN INJURY WHICH REQUIRES MEDICAL TREATMENT BEYOND FIRST AID; OR PROPERTY DAMAGE IN EXCESS OF \$2000 OR COMPLETE LOSS OF THE VESSEL. REPORTS IN DEATH AND INJURY CASES MUST BE SUBMITTED WITHIN 48 HOURS. REPORTS IN OTHER CASES MUST BE SUBMITTED WITHIN 10 DAYS. REPORTS MUST BE SUBMITTED TO THE REPORTING AUTHORITY IN THE STATE WHERE THE ACCIDENT OCCURRED. THIS FORM IS PROVIDED TO ASSIST THE OPERATOR IN FILING THE REQUIRED WRITTEN REPORT.						
COMPLETE ALL BLOCKS (INDICATE THOSE NOT APPLICABLE BY "NA")						
ACCIDENT DATA						
DATE OF ACCIDENT	TIME	AM PM	NAME OF BODY OF WATER	LOCATION (GIVE LOCATION PRECISELY)		
NUMBER OF VESSELS INVOLVED	NEAREST CITY OR TOWN		COUNTY	STATE	ZIP CODE	
WEATHER (CHECK ALL APPLICABLE) [] CLEAR [] RAIN [] CLOUDY [] SNOW [] FOG [] HAZY	WATER CONDITIONS [] CALM (WAVES LESS THAN 6") [] CHOPPY (WAVES 6" TO 2') [] ROUGH (WAVES 2' TO 6') [] VERY ROUGH (GREATER THAN 6') [] STRONG CURRENT		TEMPERATURE (ESTIMATE) AIR _____ °F WATER _____ °F	WIND [] NONE [] LIGHT (0-6 MPH) [] MODERATE (7-14 MPH) [] STRONG (15-25 MPH) [] STORM (OVER 25 MPH)		
VISIBILITY DAY NIGHT [] GOOD [] [] FAIR [] [] POOR []			NAME OF OPERATOR			
OPERATOR TELEPHONE NUMBER ()			OPERATOR ADDRESS			
OPERATOR TELEPHONE NUMBER ()	DATE OF BIRTH MO DAY YR	OPERATOR'S EXPERIENCE [] NONE [] UNDER 100 HOURS [] > 100 HOURS		INSTRUCTION IN BOATING SAFETY [] STATE COURSE [] U.S. POWER SQUADRON [] USCG AUXILIARY [] AMERICAN RED CROSS [] NONE		
[] MALE [] FEMALE	NAME OF OWNER					
OWNER TELEPHONE NUMBER ()			OWNER ADDRESS			
OWNER TELEPHONE NUMBER ()	NUMBER OF PEOPLE ON BOARD	NUMBER OF PEOPLE BEING TOWED		RENTED BOAT? [] YES [] NO		
BOAT NO. 1 (THIS VESSEL)						
BOAT REGISTRATION OR DOCUMENTATION NUMBER		STATE	HULL IDENTIFICATION NUMBER		BOAT NAME	
BOAT MANUFACTURER		LENGTH	MODEL		YEAR BUILT	
TYPE OF BOAT [] OPEN MOTORBOAT [] CABIN MOTORBOAT [] AUXILIARY SAIL [] SAIL (ONLY) [] ROWBOAT [] CANOE/KAYAK [] PERSONAL WATERCRAFT [] PONTOON BOAT [] HOUSEBOAT [] OTHER (SPECIFY)	HULL MATERIAL [] WOOD [] ALUMINUM [] STEEL [] FIBERGLASS [] RUBBER/VINYL/CANVAS [] RIGID HULL INFLATABLE [] OTHER (SPECIFY)		ENGINE [] OUTBOARD [] INBOARD [] INBOARD- STERNDRIVE (I/O) [] AIRBOAT	PROPULSION [] PROPELLER [] WATER JET [] AIR THRUST [] MANUAL [] SAIL	PERSONAL FLOTATION DEVICES (PFDS): WAS BOAT ADEQUATELY EQUIPPED WITH COAST GUARD APPROVED PFDS? [] YES [] NO WERE PFDS ACCESSIBLE? [] YES [] NO	
FUEL [] GASOLINE [] DIESEL [] ELECTRIC		NUMBER OF ENGINES TOTAL HORSEPOWER		FIRE EXTINGUISHERS ON BOARD? [] YES [] NO USED? [] YES [] NO		
OPERATION AT TIME OF ACCIDENT (CHECK ALL APPLICABLE) [] CRUISING [] CHANGING DIRECTION [] CHANGING SPEED [] DRIFTING [] TOWING [] BEING TOWED [] ROWING/PADDLING [] SAILING [] LAUNCHING [] DOCKING/UNDOCKING [] AT ANCHOR [] TIED TO DOCK/MOORED [] OTHER (SPECIFY)		ACTIVITY AT TIME OF ACCIDENT (CHECK ANY IF APPLICABLE) [] FISHING [] TOURNAMENT [] HUNTING [] SWIMMING/DIVING [] MAKING REPAIRS [] WATERSKIING/TUBING/ETC. [] RACING [] WHITEWATER SPORTS [] FUELING [] STARTING ENGINE [] NON-RECREATIONAL [] OTHER (SPECIFY)		TYPE OF ACCIDENT [] GROUNDING [] CAPSIZING [] FLOODING/SWAMPING [] SINKING [] FIRE OR EXPLOSION (FUEL) [] FIRE OR EXPLOSION (OTHER) [] SKIER MISHAP [] COLLISION WITH VESSEL [] COLLISION WITH FIXED OBJECT [] COLLISION WITH FLOATING OBJ. [] FALLS OVERBOARD [] FALLS IN BOAT [] STRUCK BY BOAT [] STRUCK BY MOTOR/PROPELLER [] STRUCK SUBMERGED OBJECT [] OTHER (SPECIFY)		WHAT CONTRIBUTED TO ACCIDENT? (CHECK ALL APPLICABLE) [] WEATHER [] EXCESSIVE SPEED [] IMPROPER LOOKOUT [] RESTRICTED VISION [] OVERLOADING [] IMPROPER LOADING [] HAZARDOUS WATERS [] ALCOHOL USE [] DRUG USE [] HULL FAILURE [] MACHINERY FAILURE [] EQUIPMENT FAILURE [] OPERATOR INEXPERIENCE [] OPERATOR INATTENTION [] CONGESTED WATERS [] PASSENGER/SKIER BEHAVIOR [] DAM/LOCK [] OTHER (SPECIFY)
ESTIMATED SPEED [] NONE [] UNDER 10 MPH [] 10 - 20 MPH [] 21 - 40 MPH [] OVER 40 MPH	[] HIT AND RUN					

Accident Report

DECEASED (IF MORE THAN 2 FATALITIES, ATTACH ADDITIONAL FORMS)			
NAME OF VICTIM		ADDRESS OF VICTIM	
DATE OF BIRTH	[] MALE [] FEMALE	DEATH CAUSED BY	[] DROWNING [] OTHER [] DISAPPEARANCE
NAME OF VICTIM		ADDRESS OF VICTIM	
DATE OF BIRTH	[] MALE [] FEMALE	DEATH CAUSED BY	[] DROWNING [] OTHER [] DISAPPEARANCE
INJURED (IF MORE THAN 2 INJURIES, ATTACH ADDITIONAL FORMS)			
NAME OF VICTIM		ADDRESS OF VICTIM	
DATE OF BIRTH	MEDICAL TREATMENT BEYOND FIRST AID? [] YES [] NO ADMITTED TO HOSPITAL? [] YES [] NO	DESCRIBE INJURY	
WAS PFD WORN? [] YES [] NO	PRIOR TO ACCIDENT? [] YES [] NO	AS A RESULT OF ACCIDENT? [] YES [] NO	
WAS IT INFLATABLE? [] YES [] NO			
NAME OF VICTIM		ADDRESS OF VICTIM	
DATE OF BIRTH	MEDICAL TREATMENT BEYOND FIRST AID? [] YES [] NO ADMITTED TO HOSPITAL? [] YES [] NO	DESCRIBE INJURY	
WAS PFD WORN? [] YES [] NO	PRIOR TO ACCIDENT? [] YES [] NO	AS A RESULT OF ACCIDENT? [] YES [] NO	
WAS IT INFLATABLE? [] YES [] NO			
OTHER PEOPLE ABOARD THIS BOAT (IF MORE THAN 2 PEOPLE, ATTACH ADDITIONAL FORMS)			
NAME		ADDRESS	
DATE OF BIRTH	WAS PFD WORN? [] YES [] NO AS A RESULT OF ACCIDENT [] YES [] NO	PRIOR TO ACCIDENT? [] YES [] NO	WAS IT INFLATABLE? [] YES [] NO
NAME		ADDRESS	
DATE OF BIRTH	WAS PFD WORN? [] YES [] NO AS A RESULT OF ACCIDENT [] YES [] NO	PRIOR TO ACCIDENT? [] YES [] NO	WAS IT INFLATABLE? [] YES [] NO
BOAT NO. 2 (IF MORE THAN 2 VESSELS, ATTACH ADDITIONAL IDENTIFYING INFORMATION)			
NAME OF OPERATOR		OPERATOR ADDRESS	
OPERATOR TELEPHONE NUMBER ()		BOAT REGISTRATION OR DOCUMENTATION NUMBER	STATE
NAME OF OWNER		OWNER ADDRESS	
OWNER TELEPHONE NUMBER ()			
PROPERTY DAMAGE			
ESTIMATED AMOUNT: THIS BOAT AND CONTENTS:	OTHER BOAT(S) AND CONTENTS:	OTHER PROPERTY:	
\$	\$	\$	
DESCRIBE PROPERTY DAMAGED			
WITNESSES NOT ON THIS VESSEL			
NAME	ADDRESS	TELEPHONE NUMBER ()	
NAME	ADDRESS	TELEPHONE NUMBER ()	
PERSON COMPLETING REPORT			
NAME	ADDRESS	TELEPHONE NUMBER ()	
SIGNATURE	QUALIFICATION [] OPERATOR [] OWNER [] INVESTIGATOR [] OTHER	DATE SUBMITTED	
FOR AGENCY USE ONLY			
CAUSES BASED ON (CHECK ONE): [] THIS REPORT [] INVESTIGATION [] INVESTIGATION AND THIS REPORT [] OTHER			
NAME OF REVIEWING OFFICE	DATE RECEIVED	RECREATIONAL []	NON-REPORTABLE []
PRIMARY CAUSE	COMMERCIAL [] SECONDARY CAUSE		

Call the Coast Guard Infoline 1-800-368-5647 for information on **Federal Requirements for Recreational Boats**

Accident Report

ACCIDENT DESCRIPTION

DESCRIBE WHAT HAPPENED (SEQUENCE OF EVENTS. INCLUDE FAILURE OF EQUIPMENT. INCLUDE A DIAGRAM IF NEEDED. CONTINUE ON ADDITIONAL SHEETS IF NECESSARY. INCLUDE ANY INFORMATION REGARDING THE INVOLVEMENT OF ALCOHOL AN/OR DRUGS IN CAUSING OR CONTRIBUTING TO THE ACCIDENT. INCLUDE ANY DESCRIPTIVE INFORMATION ABOUT THE USE OF PFD'S.)

An agency may not conduct or sponsor and a person is not required to respond to an information collection, unless it displays a currently valid OMB Control Number. The Coast Guard estimates that the average burden for this report form is 30 minutes. You may submit any comments concerning the accuracy of this burden estimate or any suggestions for reducing the burden to: Commandant (G-OPB-1), U.S. Coast Guard, Washington, DC 20593-0001 or Office of Management and Budget, Paperwork Reduction Project (2115-0010), Washington, DC 20503.

NOTES

FLOAT PLAN

Everglades recommends filling out a float plan each time you use your boat for an off-shore day trip or a long cruise. Leave this information with a responsible person ashore, like a close friend or relative that you know well.

1. Name of person reporting and telephone number.

2. Description of boat.
Type _____ Color _____ Trim _____
Registration No. _____ Length _____
Name _____ Make _____ Other Info _____

3. Engine type _____ H.P. _____
No. of Engines _____ Fuel Capacity _____

4. Survival equipment: (Check as appropriate)

<input type="checkbox"/> PFDS	<input type="checkbox"/> Flares	<input type="checkbox"/> Mirror
<input type="checkbox"/> Smoke Signals	<input type="checkbox"/> Flashlight	<input type="checkbox"/> Food
<input type="checkbox"/> Paddles	<input type="checkbox"/> Water	<input type="checkbox"/> Others
<input type="checkbox"/> Anchor	<input type="checkbox"/> Raft or Dinghy	<input type="checkbox"/> EPIRB

5. Radio Yes No Type _____

6. Automobile license _____
Type _____ Trailer License _____
Color _____ and make of auto _____

7. Persons aboard _____
Name _____ Age _____ Address & telephone No. _____

8. Do any of the persons aboard have a medical problem?
 Yes No If yes, what? _____

9. Trip Expectations: Leave at _____
From _____ Going to _____
Expect to return by _____ (time)
and no later than _____

10. Any other pertinent info. _____

11. If not returned by _____ (time)
call the COAST GUARD or (Local authority) _____

12. Telephone Numbers.

NOTES

TROUBLESHOOTING GUIDE

PROBLEM	CAUSE AND SOLUTION
CONTROL SYSTEMS	
<p>Hydraulic Steering is slow to respond & erratic.</p>	<ul style="list-style-type: none"> • Steering system is low on fluid. Fill and bleed system. • Steering system has air in it. Fill and bleed system. • A component in the steering system is binding. Check and adjust or repair binding component. • Engine steering spindle is binding. Grease spindle.
<p>The boat wanders and will not hold a course at cruise speeds.</p>	<ul style="list-style-type: none"> • There could be air in the steering system. Fill & bleed the system. • The engine steering tab is corroded or out of adjustment. Replace or adjust steering tab. • Engine steering spindle is binding. Grease spindle.
<p>An engine will not start with the shift control lever in neutral.</p>	<ul style="list-style-type: none"> • The control cable is out of adjustment & not activating the neutral safety cut out switch. • The shift control lever is not in the neutral detent. Try moving the shift lever slightly. • There is a loose wire on the neutral safety switch on the control. Inspect wires and repair loose connections. • The starter or ignition switch is bad. • There is a problem with the electronic control system at the helm control, module or at the engine. Have the system serviced by a qualified marine technician.
PERFORMANCE PROBLEMS	
<p>Boat is sluggish and has lost speed & RPM.</p>	<ul style="list-style-type: none"> • The boat may need to have marine growth cleaned from hull and running gear. • Propellers may be damaged & need repair. • Weeds or line around the propellers. Clean propellers. • Boat is overloaded. Reduce load. • Check for excessive water in the bilge. Pump out bilge & find & correct the problem. • The throttle adjustment has changed and the engine is not getting full throttle. Adjust the throttle cable. • One of the throttles is not responding properly and the engine is not getting full throttle. Have the throttle control checked by a qualified marine technician.
<p>The boat vibrates at cruising speeds.</p>	<ul style="list-style-type: none"> • Propellers may be damaged & need repair. • A propeller or propeller shaft is bent. Repair or replace damaged components. • The running gear is fouled by marine growth or rope. Clean running gear. • The engines are not trimmed properly. Trim engines.

PROBLEM	CAUSE AND SOLUTION
ENGINE PROBLEMS	
<p>An engine is running too hot.</p>	<ul style="list-style-type: none"> • The engine raw water pick up strainer is clogged with marine growth. Clean pick up. • The engine raw water pump impeller is worn or damaged. Repair the pump. • The engine thermostat is faulty and needs to be replaced.
<p>An engine alternator is not charging properly.</p>	<ul style="list-style-type: none"> • The battery cable is loose or corroded. Clean and tighten battery cables. • The alternator is not charging and must be replaced. • The battery is defective. Replace the battery.
<p>An engine suddenly will not operate over 2000 RPM.</p>	<ul style="list-style-type: none"> • The engine emergency system has been activated. The on board computer has sensed a problem and has limited the RPM to protect the engine. Find & correct the problem. • The tachometer is bad and needs to be replaced. • The oil tank on 2-cycle engines is low on oil. Fill the engine oil tank. Refer to the engine owner's manual. • A throttle control is not responding properly. Have the throttle setting checked by a qualified technician.
<p>An engine is loosing RPM. The boat is not overloaded and the hull bottom and running gear are clean and in good condition.</p>	<ul style="list-style-type: none"> • The engine may be having a problem with a sticky Anti-siphon valve, located in the fuel line near the fuel tank, that is restricting the fuel flow. Remove & clean or replace the Anti-siphon valve. • The remote gasoline fuel filter could be dirty. Inspect and replace the fuel filter. • The primary fuel filter on the engine may be dirty. Inspect and replace the fuel filter. • The electronic engine control system on the engine is malfunctioning. Repair the engine control system. • The fuel injection system on the engine is malfunctioning. Repair the fuel injection system.

PROBLEM	CAUSE AND SOLUTION
ACCESSORY PROBLEMS	
The baitwell pump runs, but does not pump water.	<ul style="list-style-type: none"> • The strainer on the intake scoop is clogged preventing the water from getting to the pump. Put the boat in reverse to clean the strainer. • There is an air lock in the system. Prime the system. • The thru-hull valve is not open. Open valve.
The fresh water pump runs, but will not pump water.	<ul style="list-style-type: none"> • The water tank is empty. Fill the tank. • The intake hose is damaged and sucking air. Replace or repair the hose. • The pump is defective. Repair or replace the pump.
The fishbox pump out pump runs, but does not pump out the fishbox.	<ul style="list-style-type: none"> • The pump has an air lock. Fill the fishbox half full of water, then turn the pump on and off several times to move the air out and prime the pump. • The pump discharge line is clogged. Clean the discharge line. • The pump intake line is clogged. Clean the intake line.
The fresh water pump fails to turn off after all outlets are closed.	<ul style="list-style-type: none"> • There is a leak in a pressure line or outlet. Repair the leak. • There is an air leak in the intake line. Repair the air leak. • The pressure switch is defective. Replace the pressure switch. • The voltage to the pump is low. Check for corroded or loose wiring connections or low battery. • The strainer is clogged. Clean strainer. • The pump is defective. Repair or replace the pump.
The washdown pump runs, but the pump will not pump water.	<ul style="list-style-type: none"> • The thru-hull valve is not open. Open valve. • The in-line sea strainer for the pump is clogged. Clean the sea strainer.
The washdown or fresh water pump fails to turn off after all outlets are closed.	<ul style="list-style-type: none"> • The intake hose is damaged and sucking air. Replace hose. • The pump is defective. Repair or replace the pump. • There is a leak in a pressure line or outlet. Repair the leak. • There is an air leak in the intake line. Repair the air leak. • The pressure switch is defective. Replace the pressure switch. • The voltage to the pump is low. Check for corroded or loose wiring connections or low battery.
Reduction in water flow from the bilge pump.	<ul style="list-style-type: none"> • The strainer is clogged. Clean strainer. • The pump is defective. Repair or replace the pump. • Impeller screen plugged with debris. Clean screen at the base of the pump. • The discharge hose is pinched or clogged. Check discharge hose and clean or repair. • Low voltage to the pump. Check the battery and wire connections.

PROBLEM	CAUSE AND SOLUTION
ACCESSORY PROBLEMS	
<p>The automatic float switch on the bilge pump raises but does not activate the pump .</p>	<ul style="list-style-type: none"> • The circuit breaker or fuse for the automatic switch has tripped or blown. Reset the circuit breaker or replace the fuse. • The battery is dead. Charge or replace the battery. • The pump impeller is jammed by debris. Clean pump impeller housing. • The wire connections in the bilge have corroded. Replace connectors and secure above the bilge waterline. • The automatic switch is defective. Replace the switch. • The pump is defective. Replace pump.
<p>The bilge pump will not run when the manual switch is activated.</p>	<ul style="list-style-type: none"> • The circuit breaker supplying the switch has tripped. Reset the circuit breaker. Replace if defective. • The battery switch is off. Turn on the battery switch. • The pump impeller is jammed by debris. Clean pump impeller housing. • The wire connections in the bilge have corroded. Replace connectors and secure above the bilge waterline. • The switch is defective. Replace the switch. • The pump is defective. Replace pump.
<p>Excessive odor from portable marine head.</p>	<ul style="list-style-type: none"> • No deodorizer in the holding tank. Add deodorizer to the holding tank each time it is pumped out. • The waste in the tank is over two weeks old. Pump the holding tank if it has contained waste for two weeks or more.

Everglades

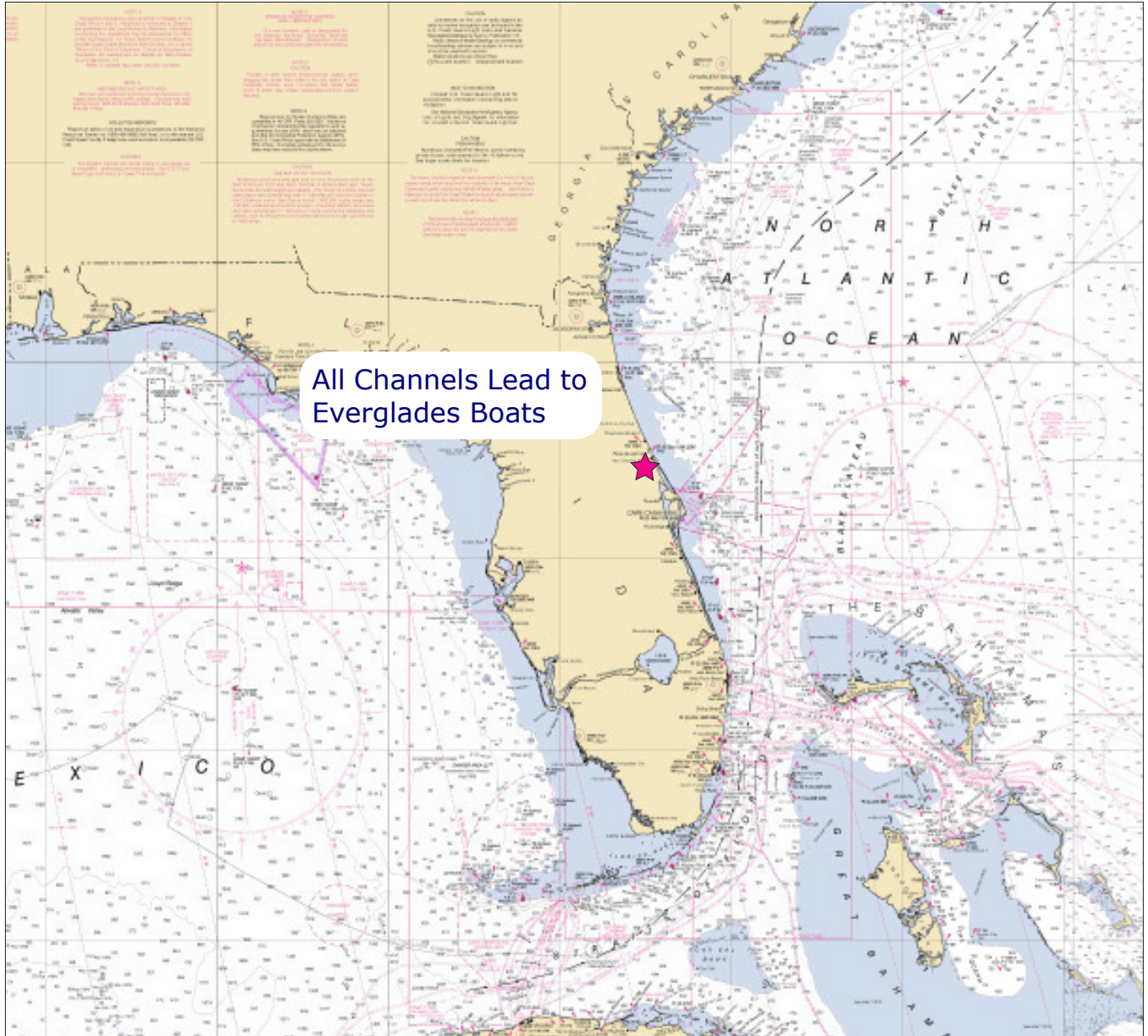

Everglades Boats
544 Air Park Road
Edgewater, Florida 32132