

350cc

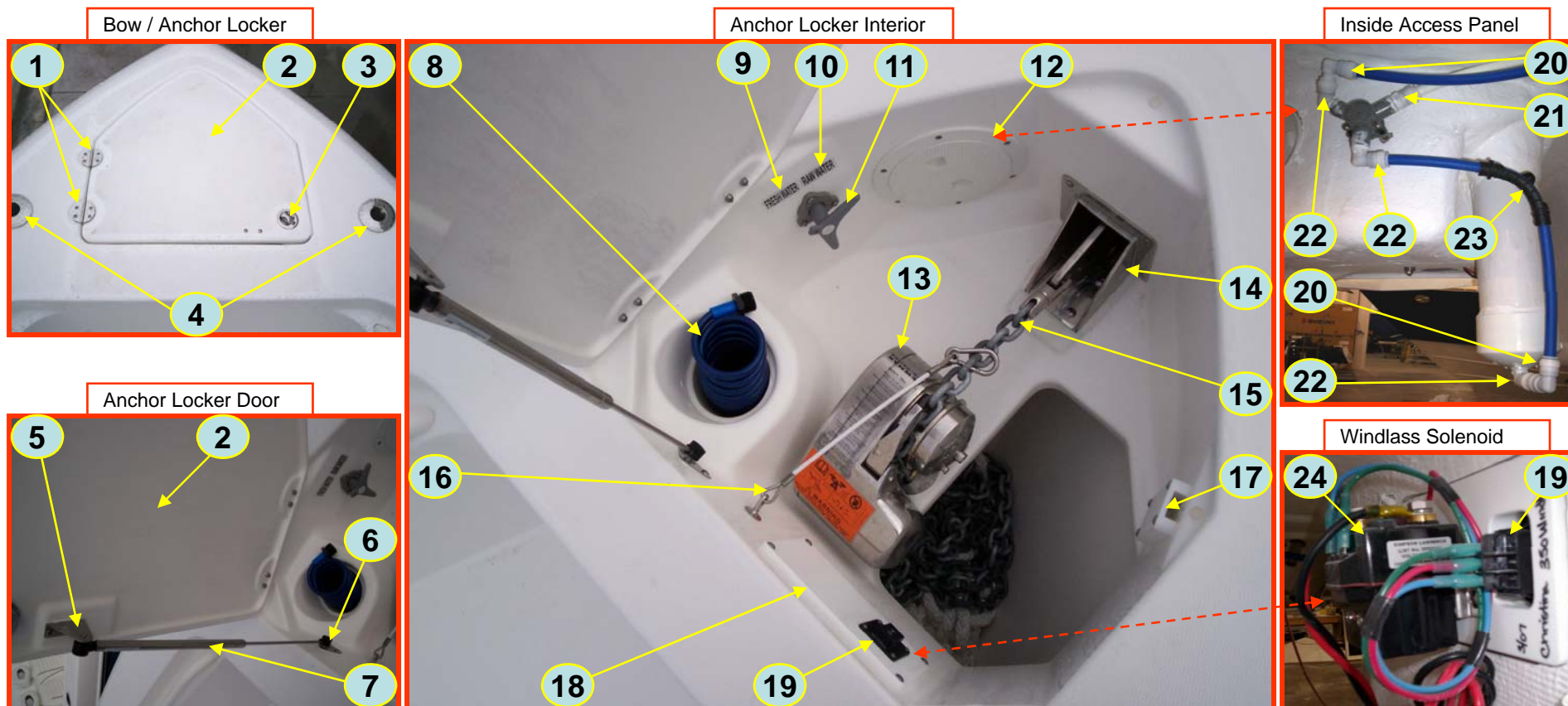

**Everglades**  
*by Dougherty*

## 350CC Anchor Locker



- |  |   |
|--|---|
| 1. GEM:130200 – Two Hole Round Hinge                   | 13. Lewmar:LM7015-09 – Windlass Pro Fish 1000G                            |
| 2. RJLM:35ANCHOR – 350 Anchor Lid                      | 14. Challenger:D35 – Bow Roller Hardware                                  |
| 3. Orcas:9121453 – Bridge Pull Slam Latch Non Locking  | 15. Lewmar:HM15HT185PX – Rope Chain Combo 185' x ½" Rope x 15' x ¼" Chain |
| 4. GEM:105532 – 30 Degree Rod Holder                   | 16. Seco South:310880 – Anchor Lanyard                                    |
| 5. SPD:BRX-1096-SS – Stainless Bracket                 | 17. Spartech:350928 – Windlass Wrench Holder                              |
| 6. SPD:BRX1020 – Stainless Flat Bracket                | 18. Spartech:350927 – 35 Windlass Panel                                   |
| 7. Ameritool:750-8-100lb – Stainless Gas Spring 100lb. | 19. Lewmar:68000593 – Rocker Switch                                       |
| 8. SeaTech:EC25201BX – Wash Down Coiled Hose 25'       | 20. SeaTech:2418-10 – ½" Stackable Elbow                                  |
| 9. BCH:Fresh Water-35 – Fresh Water Label              | 21. SeaTech:2401-1008 – ½" Male Threaded Connector                        |
| 10. BCH:Raw Water-35 – Raw Water Label                 | 22. SeaTech:2419-1008 – ½" Male Threaded Elbow                            |
| 11. Bosworth:M94A – Select Y Valve                     | 23. SeaTech:2349-15 – ½" Elbow Clip                                       |
| 12. Beckson:DP62-WP – 6" Twist Out Deck Plate          | 24. Lewmar:0052531 – Solenoid 12v.  |

## 350CC Bow Interior

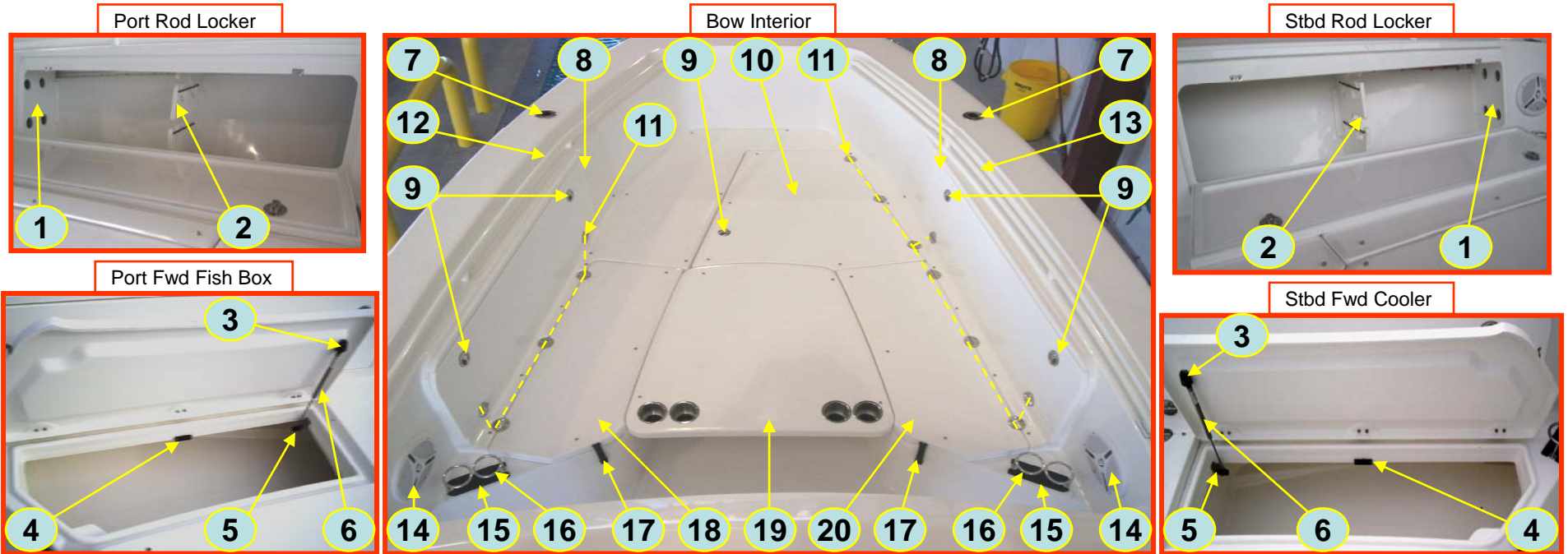

1. Spartech:350931 – Fwd Rod Holder Set
2. Teak Isle:290824 – Rod Rack Set
3. SPD:BRX1010-SS – Bracket Stainless
4. Innovative Light:006-4000-1 – 5 Red LED Light
5. RJAF:BRX – Stainless Flat Bracket
6. Ameritool:625-6L-40 – 10 ¼" x 40lb. Gas Spring
7. GEM:105532 – 30 Degree Rod Holder
8. Spartech:350912 – Fwd Rod Locker Set
9. Orcas:9121455 – Bridge Slam Latch Locking
10. RJLM:35-BOWLID – 350cc Bow Storage Lid
11. GEM:130200 – Round Two Hole Hinge
12. RJAF:35-BOWRAIL-P – 350cc Port Bow Rail
13. RJAF:35-BOWRAIL-S – 350cc Stbd Bow Rail

Fwd Bow Storage



Electric Bow Table

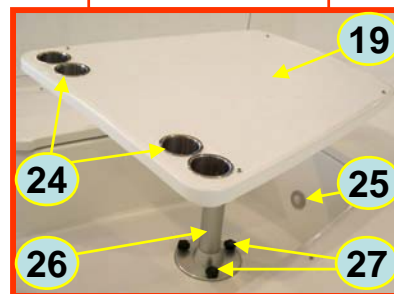

14. Prospect Electronics:JBLMS9200 – 6 x 9 Oval Speaker
15. Sano:RJCUPHOLDER – Cup Holder Tread Mat
16. King Marine:88004 – Double Ring Cup Holder Stainless
17. Southco:C7-10 – Soft Draw Latch
18. RJLM:35-FISHBOXLID – 350cc Port Fwd Fish Box Lid
19. RJLM:35-BOWTABLE – 350cc Bow Table
20. RJLM:35-COOLERLID – 350cc Stbd Fwd Cooler Lid
21. SPD:BRX1020 – 3 Hole 90 Degree Bracket
22. Ameritool:750-8-100 – 20" x 100lb. Gas Spring
23. SPD:BRX1050 – 3 Hole Flat Bracket
24. RDI:1006RDI – Single Stainless Cup Holder
25. ITC:69650-SS – Round Red / White Combo Light
26. Scandvik:40153 – Electric Table Base
27. Design / Rogan:RFS-5-J13 – Black Knob With Stud
28. Spartech:350932 – Table Switch Plate Panel

## 350CC Fwd Console

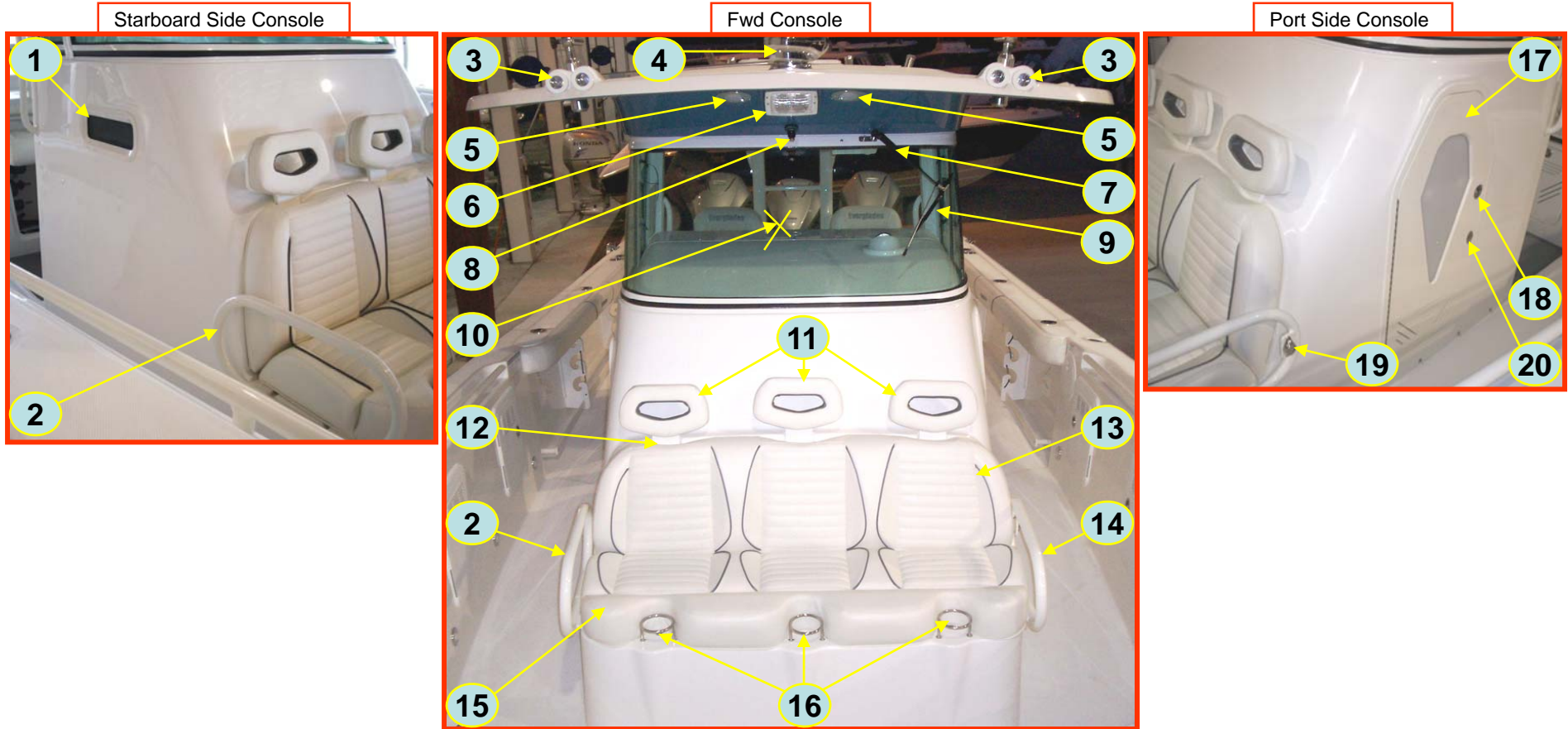

- |   |   |
|---|---|
| <ol style="list-style-type: none"> <li>1. Bomar:NC2414-THK – White Port Window</li> <li>2. RJAF:350-FCRAIL-S – Stbd Fwd Console Seat Rail</li> <li>3. BEP:MO51B-SS – Flush Mount Dock Lamps W / Cover</li> <li>4. Golight:3066 – Remote Spotlight</li> <li>5. Ongaro:11038-C – Stainless Horn Grill<br/>Ongaro:11037 – Mini Drop In Horn Hi / Low Pitch</li> <li>6. BEP:AE-06-633 – Flush Mount Twin Beam Light</li> <li>7. Ongaro:39153 – Wiper Arm 14”</li> <li>8. Orbit:54040 – Sprayer Head</li> <li>9. Ongaro:30514 – Wiper Blade 14”</li> <li>10. Taylor:885004000402 – Front Windshield<br/>Taylor:885004000506 – Port and Stbd Side Shield Wings</li> </ol> | <ol style="list-style-type: none"> <li>11. Emerald Coast:EGS35-07-130-CBR – Fwd Console Headrest</li> <li>12. Spartech:350906 – 350 Headrest</li> <li>13. Emerald Coast:EGS35-07-130CBR – Fwd Console Backrest</li> <li>14. RJAF:350-FCRAIL-P – Port Fwd Console Seat Rail</li> <li>15. Emerald Coast:EGS35-07-130-CBC – Fwd Console Seat Bottom</li> <li>16. King Marine:88002 – Single Cup Holder Stainless<br/>Seadeck:CUP-D-PAD – Cup Holder Tread Mat</li> <li>17. Teak Isle:22-19956 – Console Head Door W/ Latch</li> <li>18. Orcas:9121455 – Bridge Pull Slam Latch Locking</li> <li>19. Orcas:9321756 – Magnetic Latch Base</li> <li>20. Orcas:9121390 – Magnetic Latch Catch</li> </ol> |
|---|---|

## 350CC Aft Console

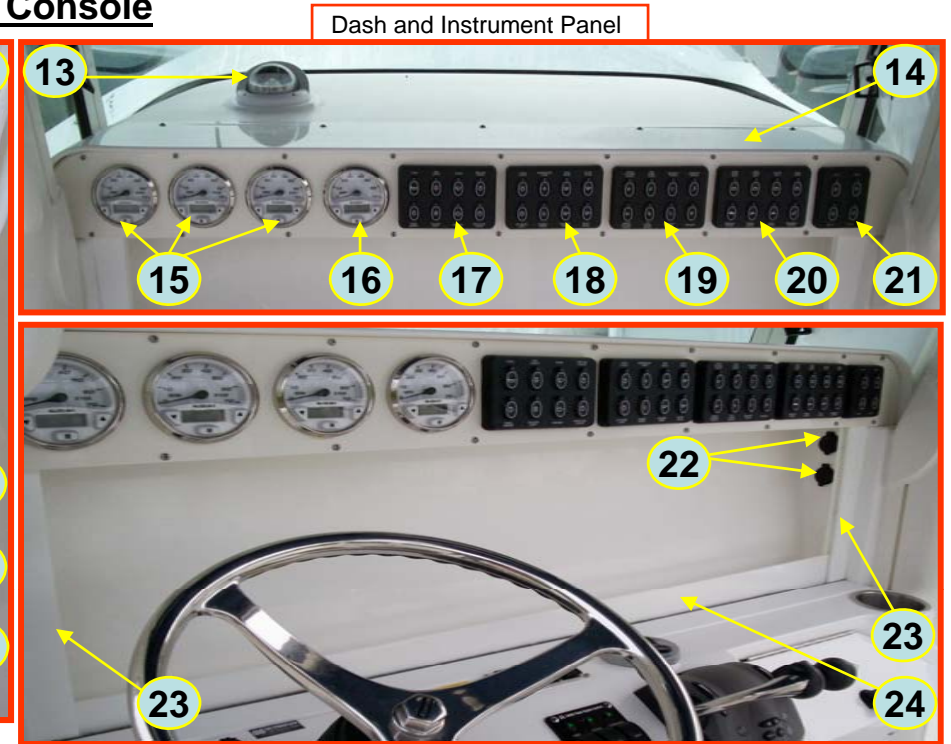
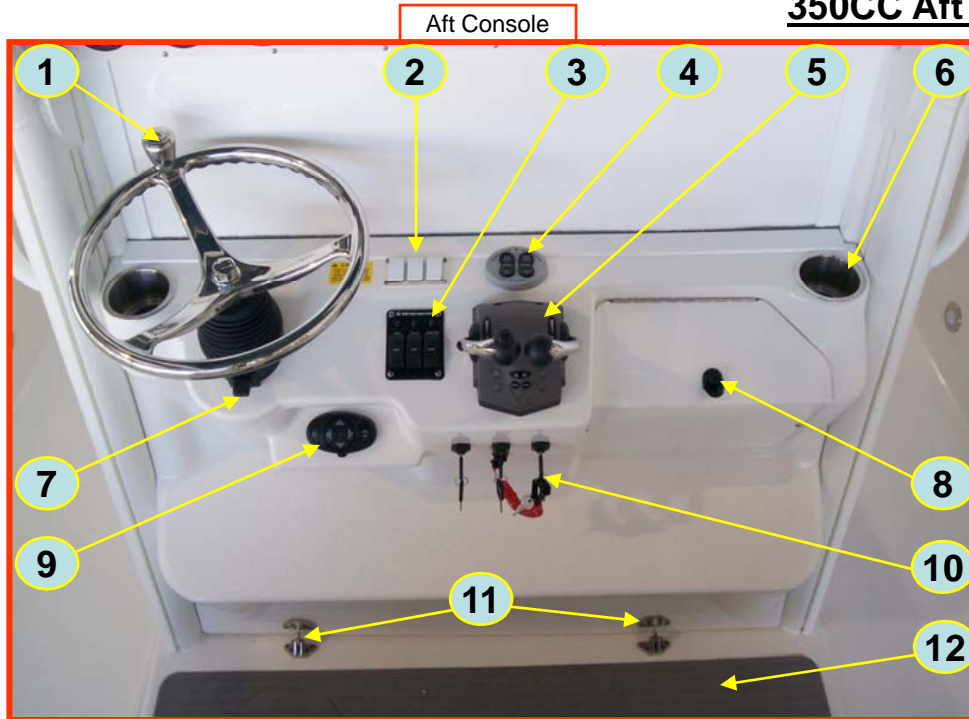

1. Edson:170ST-16-KIT – 16" Power Wheel SS Comfort Grip
2. Pacer:V8D1S00B-G0000 – Momentary Rocker Switch W / Cover
3. Teleflex:CP67600 – Triple Engine Control Panel
4. Linear:SET-50 – Trim Tab Switch Oval
5. Suzuki:67000-98J40 – Suzuki Binnacle (Suzuki Digital System)  
Teleflex::CH64502 – Dual Binnacle With Single Trim
6. RDI:1006RDI – Stainless Cup Holder Stainless
7. Teleflex:HH5290 – Hydraulic 2.0 Sport Tilt Helm
8. Spartech:350901 – 350 Glove Box
9. Golight Stryker Wireless Dash Mount Remote
10. Suzuki:37100-96J20 – Key Switch  
Honda:374452-ZW7-1a – Key Switch
11. Orcas:8631408 – Motor Box Hinge
12. Seadek:EB35HP – Anti Fatigue Mat

13. Ritchie:HF-743W – Front Read White Compass
14. Spartech:350908 – 350 Dash Visor
15. Suzuki:990C0-86W26 – Commander Multi Function Tach (Non Digital)  
Suzuki:990C0-88001 – 4" Multi Function Gauge (Digital System)  
Honda:06375-ZY3-800 – Tachometer
16. Suzuki:990C0-86W26 – Single White Speed Gauge (Non Digital)  
Suzuki:990C0-88001 – 4" Multi Function Gauge (Digital System)  
Honda:06373-ZY3-800 – Speedometer
17. DNA:91YY6248-1B – 8 Position Key Pad
18. DNA:91YY6250-1B – 8 Position Key Pad
19. DNA:91YY6249-1B – 8 Position Key Pad
20. DNA:91YY6251-1B – 8 Position Key Pad
21. DNA:91YY6252-1B – 4 Position Key Pad
22. Marincor:12VRC.OEM – 12v. Receptacle
23. Spartech:350909 – Security Shield Track (5 Pieces)
24. Spartech:350910 – Electronics Security Panel

## 350CC Electronics Security Panel

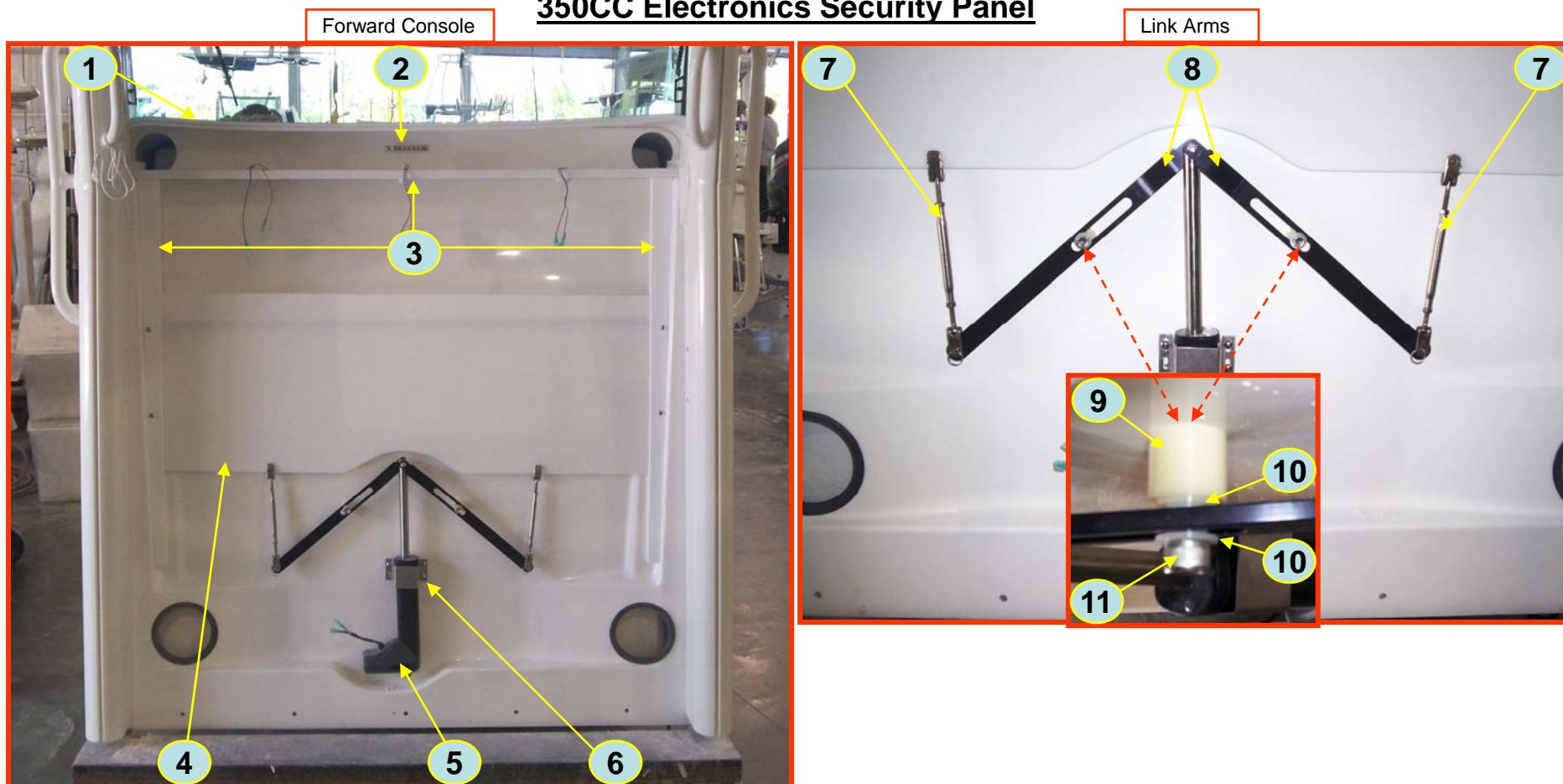

1. Spartech:350908 – 350 Dash Visor
2. Bocatech:BTMH-7 – Buss Bar
3. Spartech:350909 – 350 Security Shield Track Set
4. Spartech:350910 – 350 Electronics Security Panel
5. Miller Bearing:01-D012-0050-A08-LN – Security Shield Actuator
6. RJAF:E-BRACKET – Electronics Shield Actuator Bracket

7. C.Sherman:04-110 – Turnbuckle Jaw To Jaw SS ¼-28
8. Redline:011 – Security Shield Link Arm
9. Micro Plastic:13RS097518 – Nylon Spacer
10. Micro Plastic:12SWS2558 – 3/8” Nylon Shoulder Washer
11. Smith & Beaty Bolt:SHCS3816X214 – 3/8-16 x 2 ¼ Socket Head Screw

## 350CC Fwd Berth

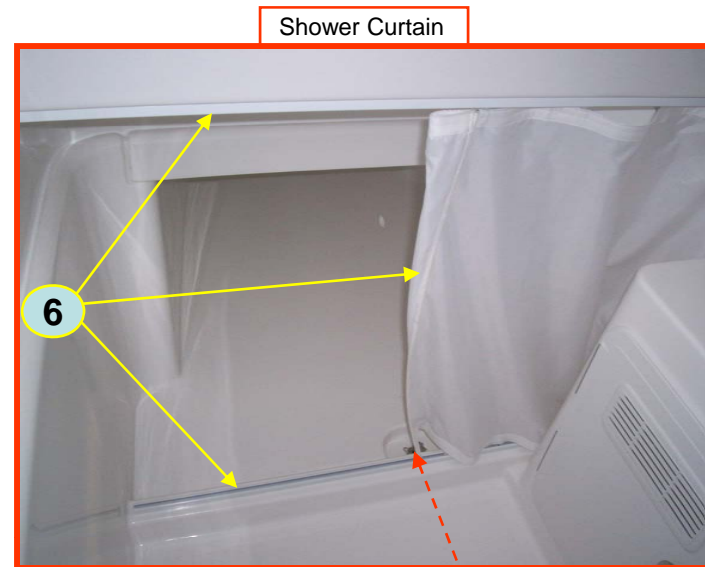

1. Spartech:350922 – 350 Head Door Access
2. Orcas:9121455 – Bridge Pull Slam Latch Locking
3. GEM:1172 – Butt Hinge
4. ITC:69660-SS – Round White Halogen Light
5. Spartech:350914 – Bow Thruster Access Cover

6. Emerald Coast:EGS35-07-150-SC – Shower Curtain and Tracks
7. Emerald Coast:EGS35-07-145-IBC – Interior Berth Cushion
8. Orcas:9005241 – 5/8" Straight Thru Hull
9. Whitecap:S-0289 – T-Handle Drain Plug

## 350CC Lower Vanity and Head



Lower Head and Vanity

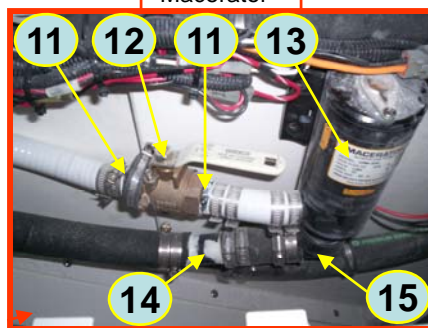

Macerator



Head Vanity

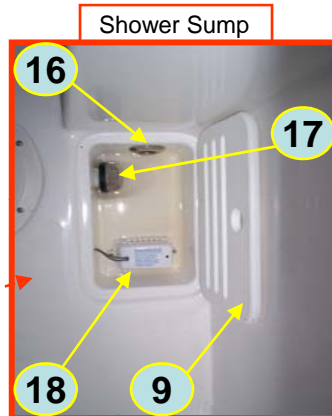

Shower Sump



Bilge Pump & Sump Pump

1. Shurflo:134-008-CP – Shower / Faucet Cold Only
2. Shurflo:136-0204-CP – Shower / Faucet Valve
3. SeaLand:371103 – Toilet Sanitation Unit
4. Innovative Marine:M1216APPW – 12" x 16" Access Panel
5. Spartech:350916 – 350 Head Close Out Front
6. Innovative Marine:MISC1618LS – 16" x 18" Left Swing Door
7. GEM:1172 – Butt Hinge
8. Beckson:DP82-WP – 8" Twist Out Deck Plate Non Skid
9. Spartech:350929 – 350 Sump Cover
10. Spartech:350915 – 350 Head Step Pad
11. Plastic Corp:62204 – Hose Adaptor
12. Groco:IBV1000 – 1" Ball Valve

13. Shurflo:3200-000 – Macerator Pump
14. Whale:YP6114 – 1 1/2" Y Fitting
15. Marine East:8060 – 1 1/2" FPT x 1 1/2" Hose Barb 90 Degree
16. Orcas:9005257 – 1 1/8" x 90 Degree Thru Hull
17. TH:AS-1 – Screen / Strainer
18. MPI:900-1000 – Sure Bail Float Switch
19. Jabsco Rule:10DM – 2000 GPH Bilge Pump
20. Whitecap:S-5051 – Brass Garboard Drain
21. Marine East:8840 – 3/4" Barb x 1 1/8" Barb Hose Adaptor
22. Jabsco Rule:403CDM – 800 GPH Bilge Pump
23. All Florida:100-107 – 3/4" inline Check Valve
24. GEM:130200 – Round Two Hole Hinge
25. Spartech:350917 – 350 Head Close Out Cover
26. Marine East:6324W – 1 1/8" x 90 Degree Drain
27. Orcas:9121390 – Magnetic Latch Catch  
Orcas:9321756 – Magnetic Latch Base
28. SSI: 30800000 – Recessed Toilet Paper Holder



## 350CC Head Aft Lockers

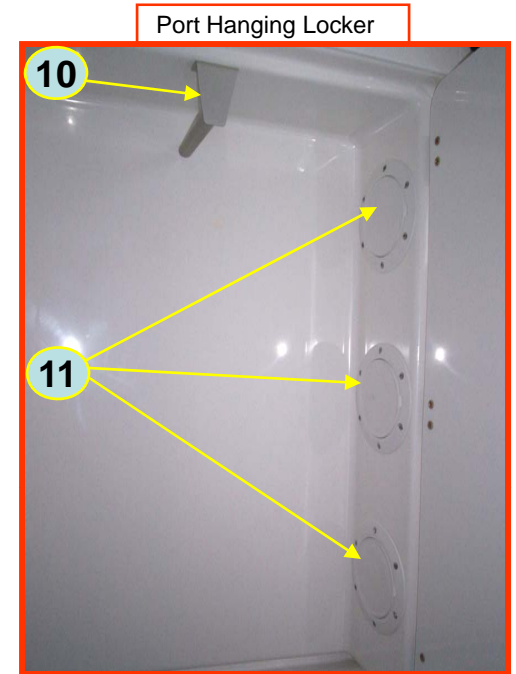
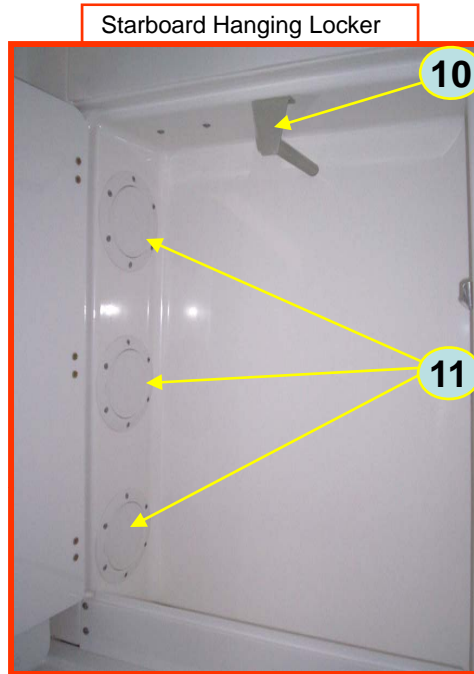
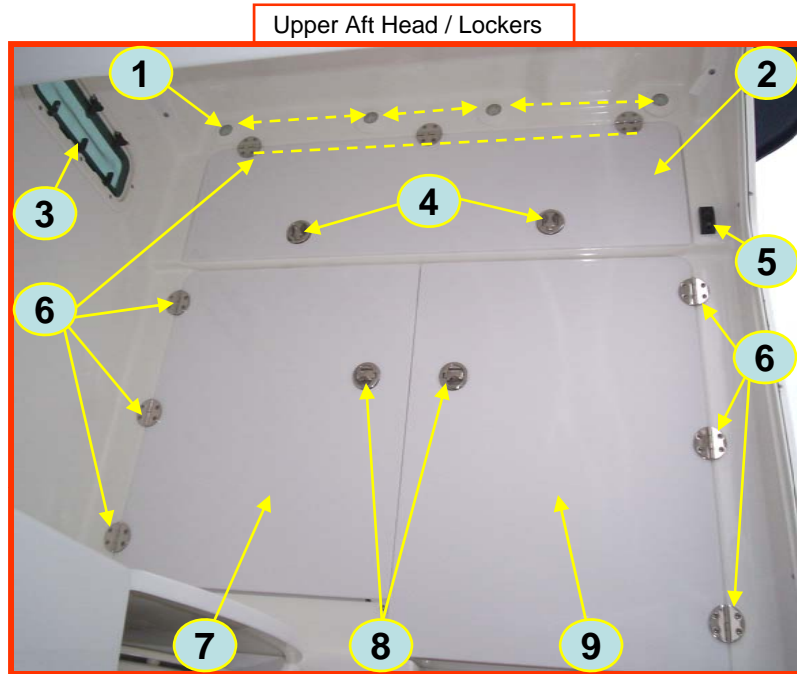

1. ITC:69660-SS – Round White LED Light White Frame
2. Spartech:350921 – 350 Electronics Access Door
3. Bomar:NC2414-THK – White Port Window
4. Orcas:9121453 – Bridge Pull Slam Latch Non Locking
5. BEP:100-BL-V-1 – Switch
6. GEM:130200 – Round Hinge Two Hole

7. Spartech:350923 – 350 Hanging Locker Door Stbd
8. Orcas:9121455 – Bridge Pull Slam latch Locking
9. Spartech:350924 – 350 Hanging Locker Door Port
10. RJAF:CLOTH-ROD – Hanging Locker Cloth Rod
11. DPI:DPPRY4W – 4" Pry Out Deck Plate

Fwd Interior Hard Top

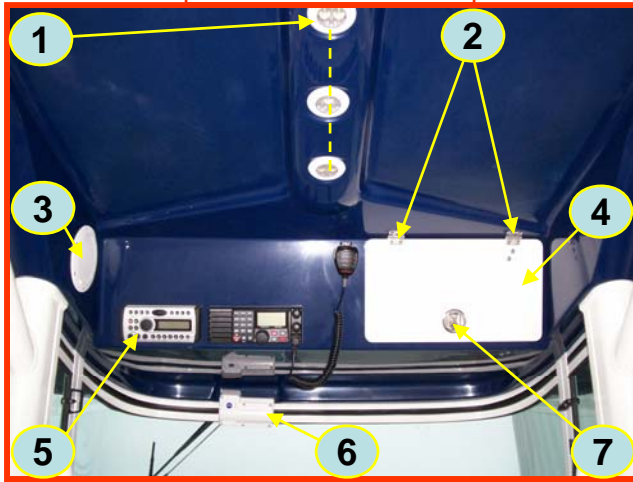

### 350CC Hard Top

Fwd Exterior Hard Top

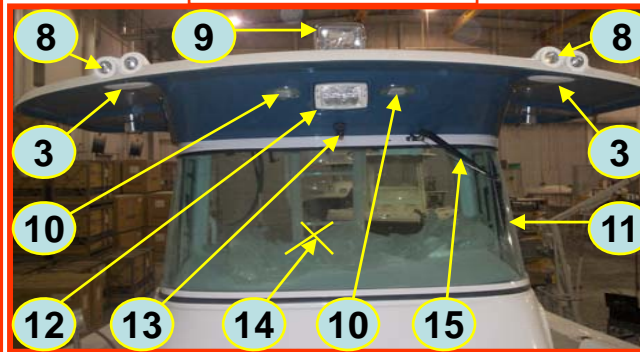

Electronics Door

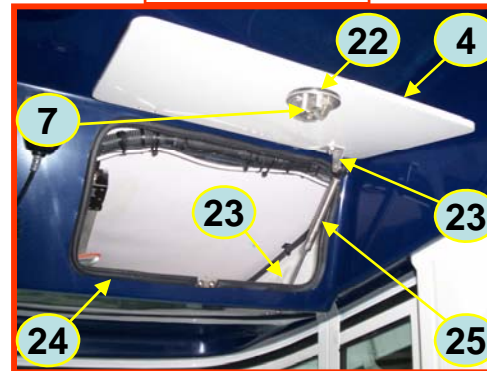

Fwd Hard Top Interior

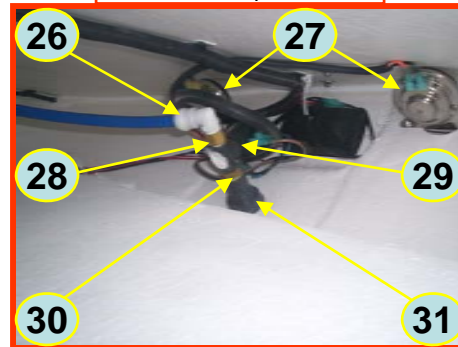

Nav Light



Aft Exterior Hard Top

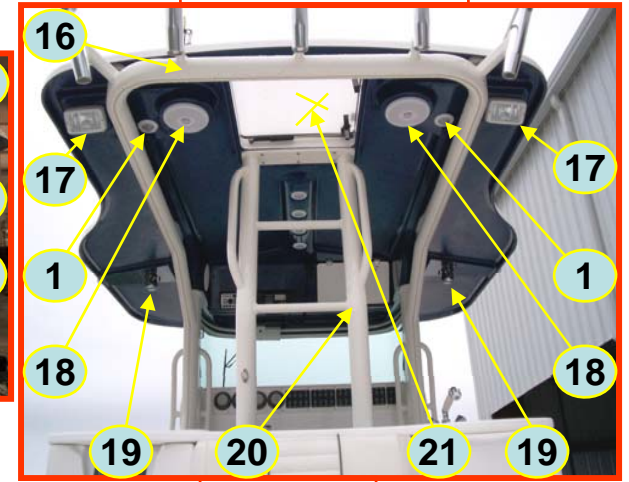

Anchor Light



1. ITC:69650-SS – Red / White Combination Light
2. GEM:1172 – Butt Hinge
3. DPI:DPPRY4PW – 4" Pry Out Deck Plate
4. Spartech:280811 – Fwd Electronics Door
5. Marine Audio:CMD4 – Stereo Head Unit (Clarion) Opt.
6. Ongaro:34002 – Water Proof Wiper Motor
7. Orcas:9121455 – Bridge Latch Locking
8. BEP:MO51B-SS – Flush Mount Dock Lamps W/Cover
9. Golight:3066 – Remote Spotlight
10. Ongaro:11038-C – Stainless Horn Grill
11. Ongaro:30514 – Wiper Blade 14"
12. BEP:AE-06-633 – Flush Mount Twin Beam Light
13. Orbit:54040 – Sprayer Head
14. Taylor:885004000402 – Front Windshield  
Taylor:885004000506 – Port and Stbd Side Shield Wings
15. Ongaro:39153 – Wiper Arm 14"
16. RJAF:350-HTFRAME – Hard Top Support Frame
17. BEP:ML-005NWW – Flush Mount Flood Spreader Light

18. ASA:AMS-602W – 6.5" White Speaker
19. Taco:GS-250A-30 – Adjustable Outrigger
20. RJAF:350-AFT-HTLADDER – Hard Top Ladder
21. Bomar:1039-NT – 20" x 20" Hard Top Hatch
22. Orcas:8921212-2 – 2mm. Latch Spacer
23. SPD:BRX-1096SS – Two Hole 90Degree Bracket
24. TrimLok:3100BX1/4A – Trimlok Black On Black
25. Ameritool MFG:625-3-20 – 10 1/4" x 20lb. Gas Spring
26. SeaTech:2419-1008 – 1/2" Male Threaded Elbow
27. Ongaro:11037 – Mini Drop In Horn Hi / Low Pitch
28. All Florida:BRA28195 – 3/8" MPT x 1/2" FPT
29. ECI:664-2207 – 12v. Solenoid Valve 3/8" Port
30. All Florida:BRA28224 – 3/4" MPT x 1/2" MPT
31. All Florida:PF872005 – 1/2" Bulkhead Fitting
32. Innovative Light:554-3100 – Port Nav Light  
Innovative Light:544-2100 – Stbd Nav Light
33. Orcas:9402530 – 40" Anchor Light W / Swivel
34. Bomar:LT-P2000-76-16 – Hatch Support Left
35. Bomar:RT-P2000-75-16 – Hatch Support Right

## 350CC Helm Seat and Battery Switch Breaker Board

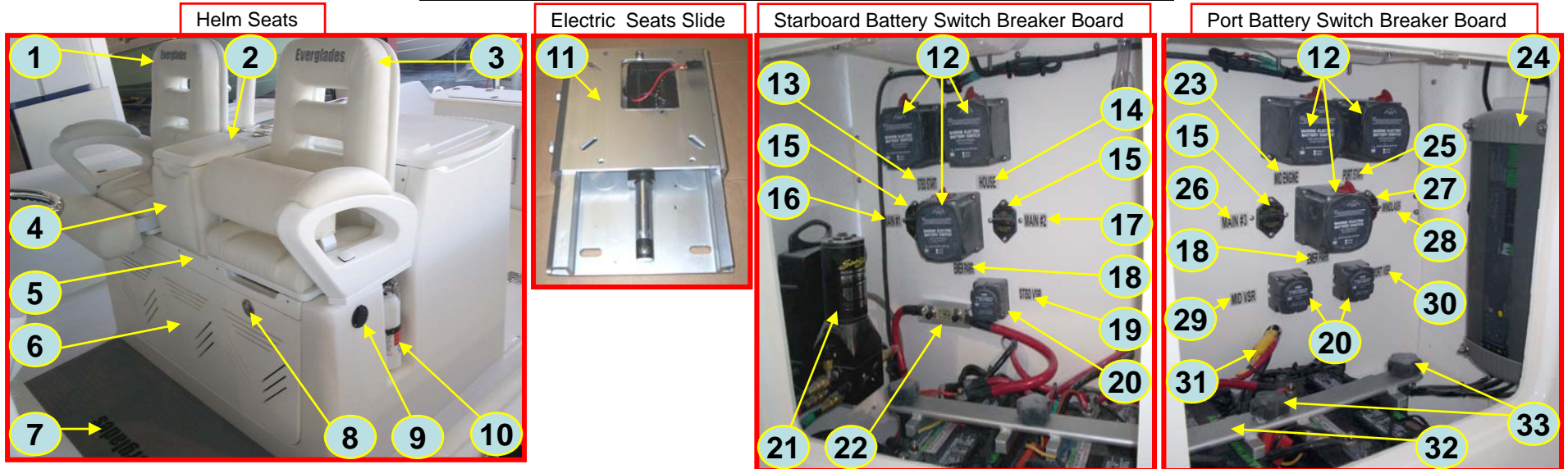

1. Todd:40-1040RVL – Right Helm Seat Chair With Switch
2. Spartech:350902 – Helm Seat Armrest  
Emerald Coast:EGS35-07-120-AHS – Helm Seat Armrest Cushion
3. Todd:40-1040EVL – Left Helm Seat Chair With Switch
4. Emerald Coast:EGS35-07-120-HL – Helm Leaning Pad
5. Spartech:350904 – Battery Cover Header
6. Spartech:350903 – Battery Cover With Vents
7. Seadek:EB35HP – Anti Fatigue Mat
8. Orcas:9121455 – Bridge Slam Latch Locking
9. Marinc:150BBI.OEM – Bass Charging Inlet
10. Metalcraft:S-130-182 – Fire Extinguisher
11. Garelick:75380101 – Electric Seat Slide

12. BEP:722-NE-300A – Electric Battery Switch
13. BCH:Stbd – Stbd Start Label
14. BCH:House – House Label
15. Blue Seas:7009B – 30 Amp. Breaker
16. BCH:Main # 1 – Main # 1 Label
17. BCH:Main # 2 – Main # 2 Label
18. BCH:Emer Parallel – Emergency Parallel Label
19. BCH:Stbd VSR – Stbd VSR Label (Voltage Sensitive Relay)
20. BEP:710-100A – Voltage Sensitive Relay Module
21. Teleflex:PA1200 – Power Assist Pump 12v.
22. Volvo:41100819 – 350 Amp. Fuse With Holder
23. BCH:Mid – Mid Engine Label
24. Pro Mariner:51034 – Charger Pro Tournament 30 Amp
25. BCH:Port – Port Start Label
26. BCH:Main # 3 – Main # 3 Label
27. Lewmar:68000240 – 70 Amp. Breaker
28. BCH:Windlass – Windlass Label
29. BCH:Mid VSR – Mid VSR Label (Voltage Sensitive Relay)
30. BCH:Port VSR – Port VSR Label (Voltage Sensitive Relay)
31. Pacer:EFH-WP – AGC Fuse Holder  
Pacer:EAGC10 – 10 Amp. Glass Fuse
32. RJAF:BAT-BAR – Battery Bank Securing Bar
33. Design / Rogan:RKF-6E11-M – Black Knob

## 350CC Workstation / Fighting Chair

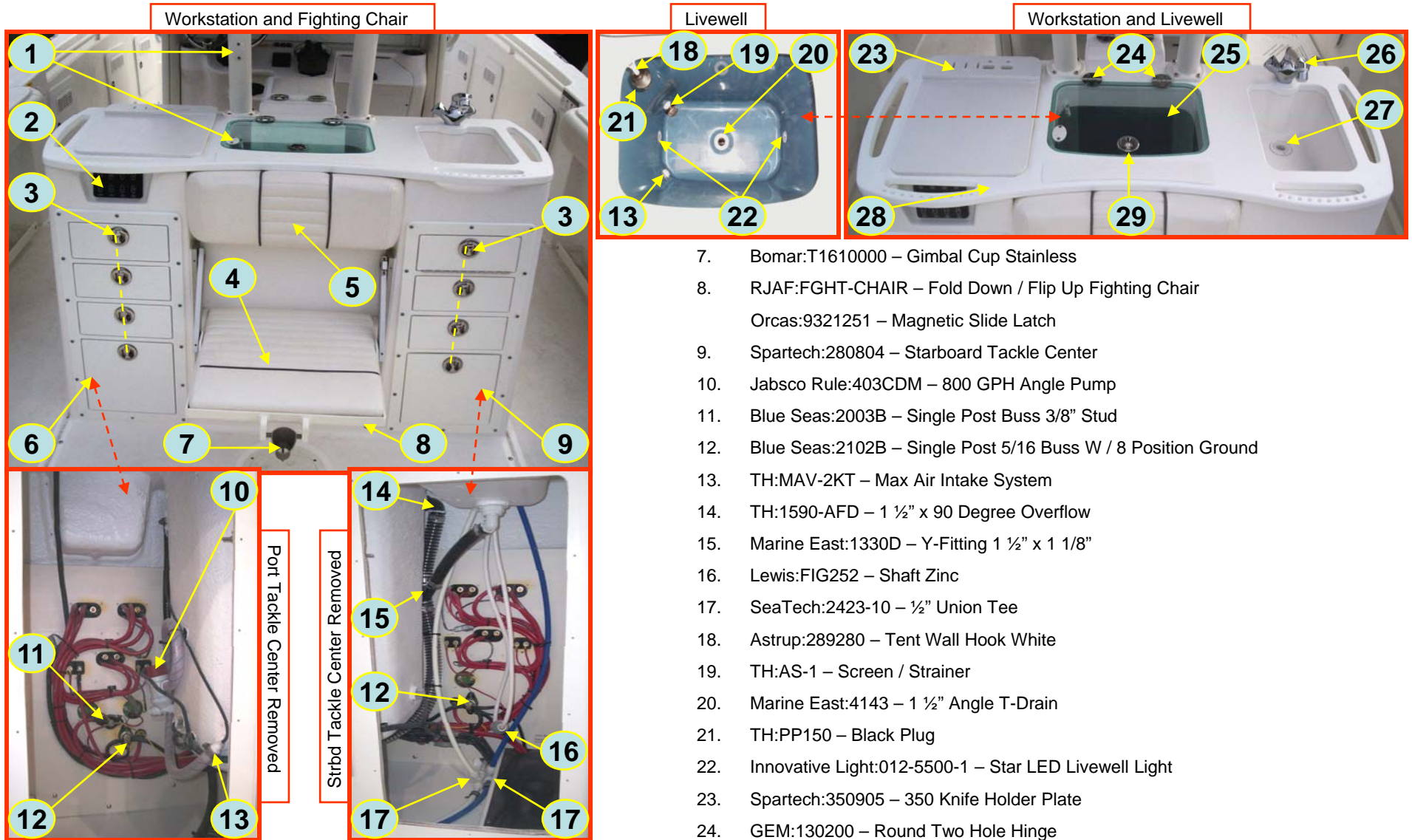

1. Orcas:9421192 – White Plastic Magnetic Latch
2. DNA:91YY6253-1 – 8 Position Livewell Key Pad
3. Orcas:9121455 – Bridge Pull Slam Latch Locking
4. Emerald Coast:EGS35-07-135-LDJ – Jump Seat Fighting Chair Bottom
5. Emerald Coast:EGS35-07-140-PCB – Jump Seat Fighting Chair Backrest
6. Spartech:280803 – Port Tackle Center

7. Bomar:T1610000 – Gimbal Cup Stainless
8. RJAF:FGHT-CHAIR – Fold Down / Flip Up Fighting Chair
- Orcas:9321251 – Magnetic Slide Latch
9. Spartech:280804 – Starboard Tackle Center
10. Jabsco Rule:403CDM – 800 GPH Angle Pump
11. Blue Seas:2003B – Single Post Buss 3/8" Stud
12. Blue Seas:2102B – Single Post 5/16 Buss W / 8 Position Ground
13. TH:MAV-2KT – Max Air Intake System
14. TH:1590-AFD – 1 1/2" x 90 Degree Overflow
15. Marine East:1330D – Y-Fitting 1 1/2" x 1 1/8"
16. Lewis:FIG252 – Shaft Zinc
17. SeaTech:2423-10 – 1/2" Union Tee
18. Astrup:289280 – Tent Wall Hook White
19. TH:AS-1 – Screen / Strainer
20. Marine East:4143 – 1 1/2" Angle T-Drain
21. TH:PP150 – Black Plug
22. Innovative Light:012-5500-1 – Star LED Livewell Light
23. Spartech:350905 – 350 Knife Holder Plate
24. GEM:130200 – Round Two Hole Hinge
25. Spartech:MIS – Helm Seat Workstation Livewell Lid
26. Shurflo:135-0204-CW – Faucet Sprayer Combo White
27. Marine East:6324W – 1 1/8" x 90 Degree Drain With Basket
28. Spartech:350900 – 350 Workstation With Lids
29. Orcas:9121453 – Bridge Pull Slam Latch Non Locking

## 350CC Port Outboard Interior

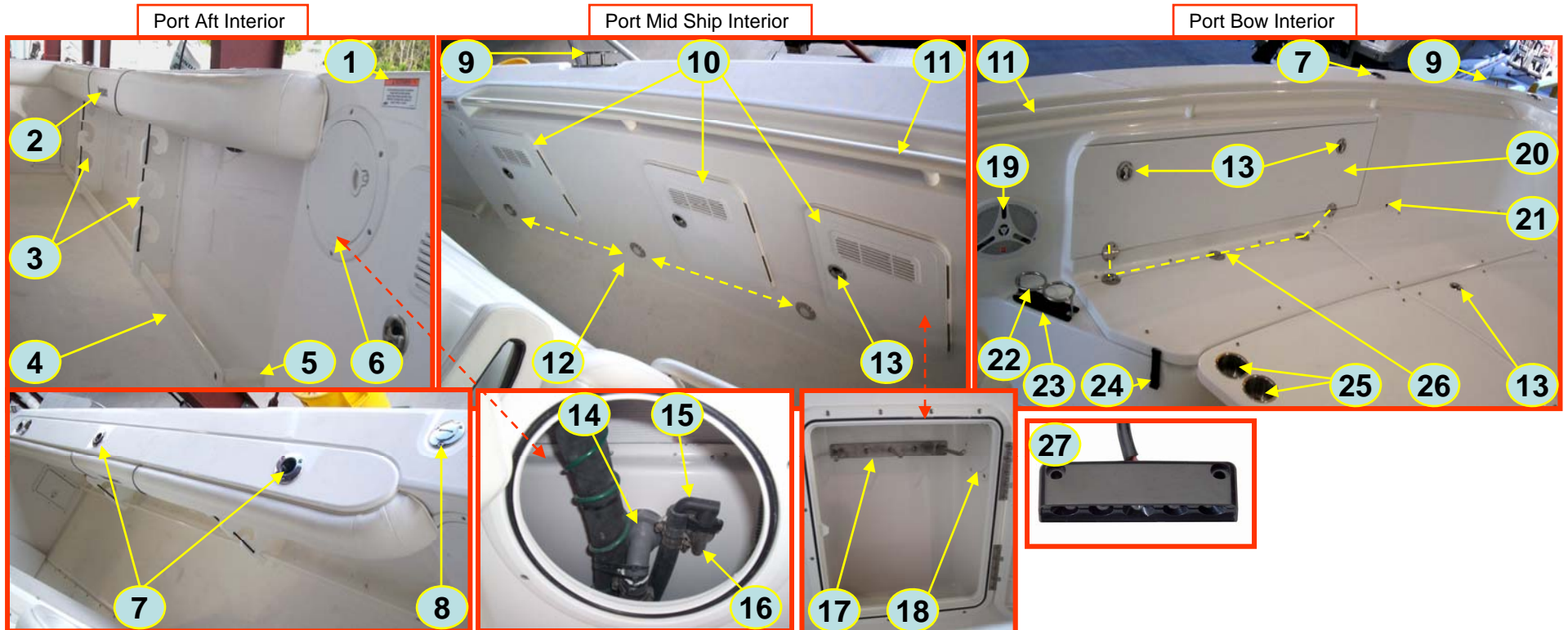

- |  |  |
|--|--|
| 1. NMMA:FSW – Fuel System Warning Label                        | 15. Orcas:9006229 – Nylon Pipe Trap                          |
| 2. Emerald Coast:EGS35-07-155-PCP – Port Coaming Pad           | 16. GEM:954 – 5/8" x 90 Degree Flush Mount Vent              |
| 3. Spartech:350918 – Rod Holder Set                            | 17. RJAF:LINEHOOK – Rope / Line Hook                         |
| 4. RJAF:35-TOERAIL-P – 350cc Port Toe Rail                     | 18. DPI:DPPRY4PW – 4" Deck Plate Pry Out                     |
| 5. RJAF:35-RAILSPACER – 350cc Toe Rail Spacer                  | 19. Prospect Electronics:JBLMS9200 – 6 x 9 Oval Speaker      |
| 6. DPI:DPPULL-8 – 10" White Deck Plate Flush Pull              | 20. Spartech:350930 – Fwd Rod Locker Set                     |
| 7. GEM:105532 – 30 Degree Rod Holder                           | 21. Orcas:9503701 – 5/8" Impact Drain Stainless              |
| 8. GEM:99601 – 1 1/2" Gas Fill Deck Plate                      | 22. King Marine:88004 – Double Ring Cup Holder Stainless     |
| 9. GEM:68301-ST – 10" Slim Line Pull Up Cleat                  | 23. Sano:RJCUPHOLDER – Cup Holder Tread Mat                  |
| 10. Innovative Product:MISC1618RS – 16" x 18" Right Swing Door | 24. Southco:C7-10 – Soft Draw Latch                          |
| 11. RJAF:35-BOWRAIL-P – 350cc Port Bow Rail                    | 25. RDI:1006RDI – Single Stainless Cup Holder                |
| 12. ITC:69650-SS – Round Red / White Combo Light               | 26. GEM:130200 – Round Two Hole Hinge                        |
| 13. Orcas:9121455 – Bridge Pull Slam Latch Locking             | 27. Innovative Light:006-4000-1 – 5 Red LED Light Black Case |
| 14. Orcas:9005257 – 1 1/8" x 90 Degree Thru Hull               | Innovative Light:006-5100-1 – 5 Red LED Light White Case     |

## 350CC Starboard Outboard Interior

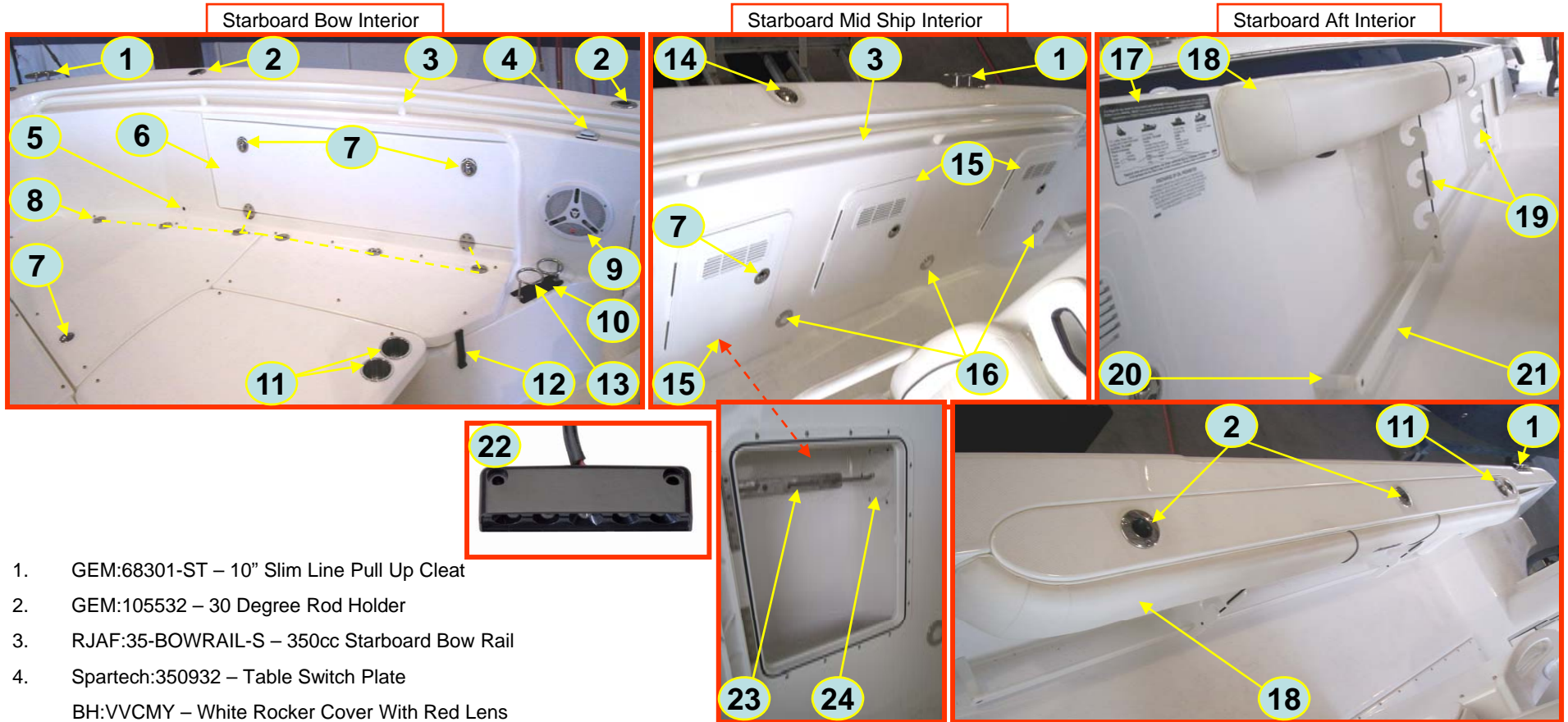

1. GEM:68301-ST – 10" Slim Line Pull Up Cleat
2. GEM:105532 – 30 Degree Rod Holder
3. RJAF:35-BOWRAIL-S – 350cc Starboard Bow Rail
4. Spartech:350932 – Table Switch Plate
- BH:VVCMY – White Rocker Cover With Red Lens
- Pacer:V8D1S00B-00000 – Momentary Rocker Switch
5. Orcas:9503701 – 5/8" Impact Drain Stainless
6. Spartech:350930 – Fwd Rod Locker Set
7. Orcas:9121455 – Bridge Pull Slam Latch Locking
8. GEM:130200 – Round Two Hole Hinge
9. Prospect Electronics:JBLMS9200 – 6 x 9 Oval Speaker
10. Sano:RJCUPHOLDER – Cup Holder Tread Mat
11. RDI:1006RDI – Single Stainless Cup Holder
12. Southco:C7-10 – Soft Draw Latch
13. King Marine:88004 – Double Ring Cup Holder Stainless
14. GEM:99901 – 1 ½" Waste Deck Plate

15. Innovative Product:MISC1618LS – 16" x 18" Left Swing Door
16. ITC:69650-SS – Round Red / White Combo Light
17. NMMA:TOBDL – Trash Overboard and Discharge Label
18. Emerald Coast:EGS35-07-155-SCP – Starboard Coaming Pad
19. Spartech:350918 – Rod Holder Set
20. RJAF:35-RAILSPACER – 350cc Toe Rail Spacer
21. RJAF:35-TOERAIL-S – 350cc Starboard Toe Rail
22. Innovative Light:006-4000-1 – 5 Red LED Light Black Case  
Innovative Light:006-5100-1 – 5 Red LED Light White Case
23. RJAF:LINEHOOK – Rope / Line Hook
24. DPI:DPPRY4PW – 4" Deck Plate Pry Out

## 350CC Aft Cockpit Interior

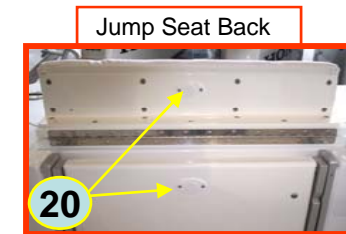
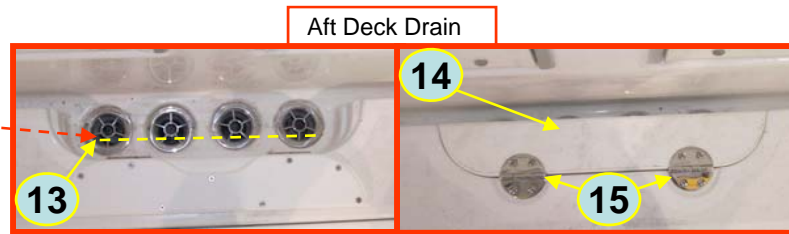
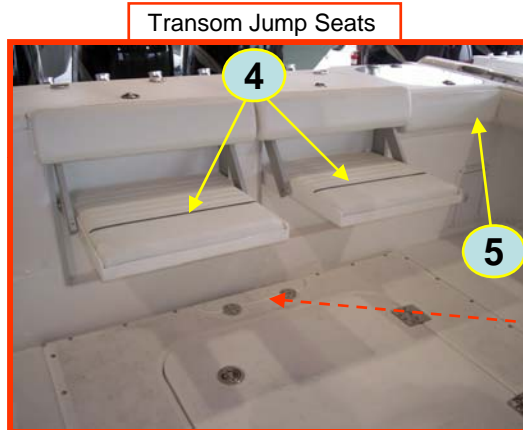
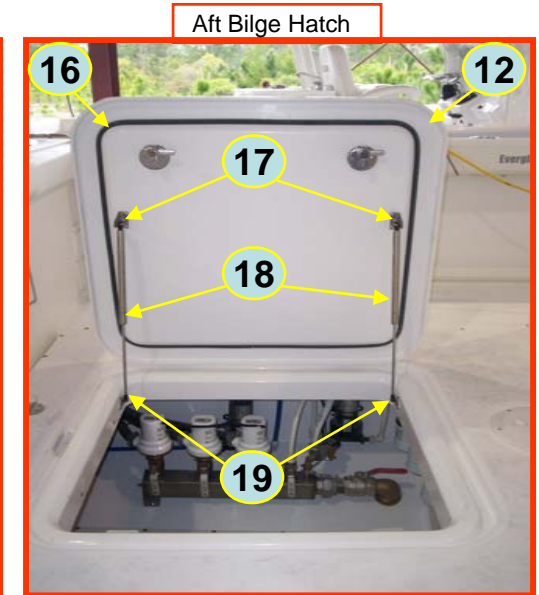
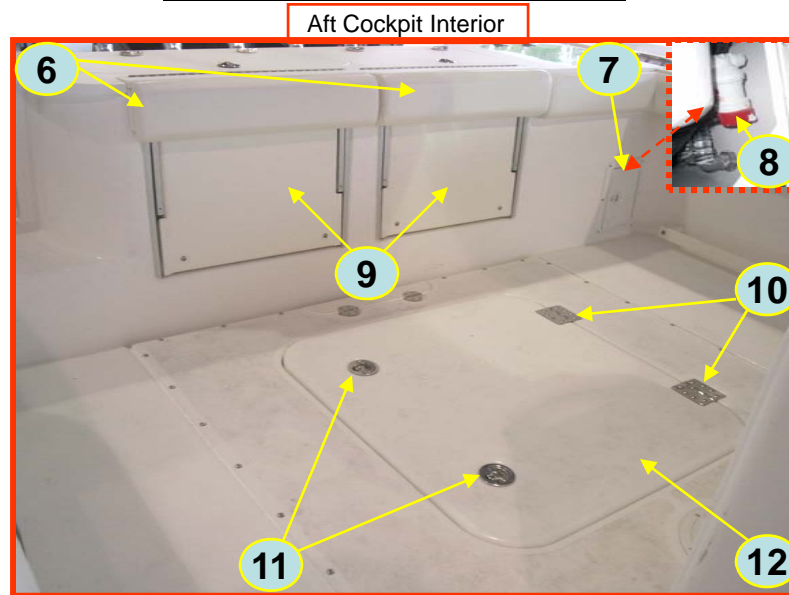
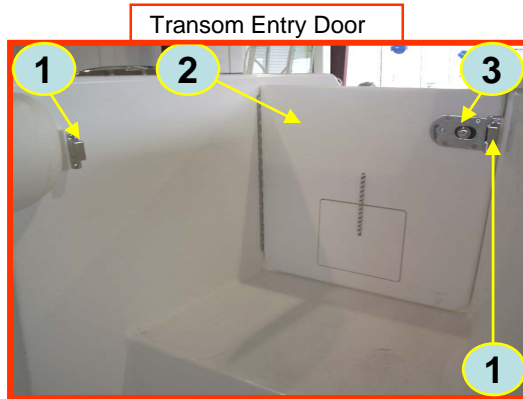

1. Orcas:9321255-1 – Magnetic Latch Receiver
2. Spartech:350926 – 350 Transom Door
3. Orcas:9321251 – Magnetic Sliding Latch
4. Emerald Coast:EGS35-07-135-LDJ – Jump Seat Bottom Cushion
5. Emerald Coast:EGS35-07-155-PCP – Port Coaming Pad
6. Emerald Coast:EGS35-07-140-TB – Transom Backrest Cushion
7. DPI:DPF912 – 9" x 12" Door
8. Jabsco Rule:403CDM – 800 GPH angle Pump
9. RJAF:35-JUMPSEAT – Fold Down / Flip Up Jump Seat
10. GEM:162601 – 4" x 4" Four Hole Hinge

11. Orcas:9421369 – D-Handle Screw Down Latch
12. RJLM – 35-BILGE-HATCH – 350cc Aft Bilge Hatch
13. Orcas:9305353 – 2" Drain Grate Stainless  
Orcas:9305353-P – Plastic Adapter 2" x 90 Degree
14. Spartech:350911 – Aft Deck Drain Cover
15. GEM:130200 – Round Two Hole Hinge
16. Clean Seal:101ST-1M – ½" x ½" Self Adhesive D-Seal
17. SPD:BRX1020 – 3 Hole 90 Degree Bracket
18. Ameritool:750-10S-55 – 55lb. Gas Spring Stainless
19. SPD:BRX1050 – 3 Hole Flat Bracket Stainless
20. Orcas:9421192 – Magnetic Latch White Plastic Flush

## 350CC Transom Workstation

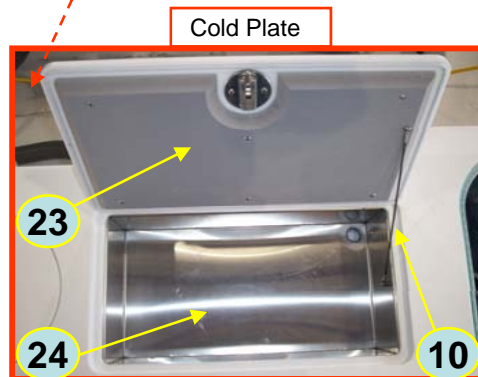
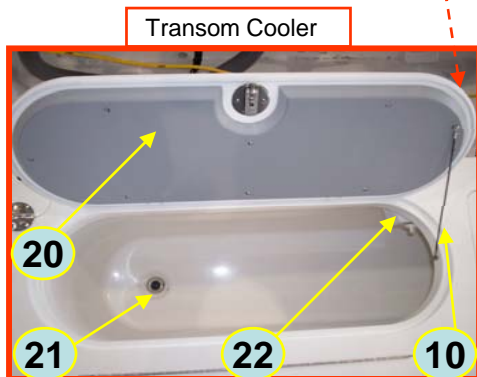
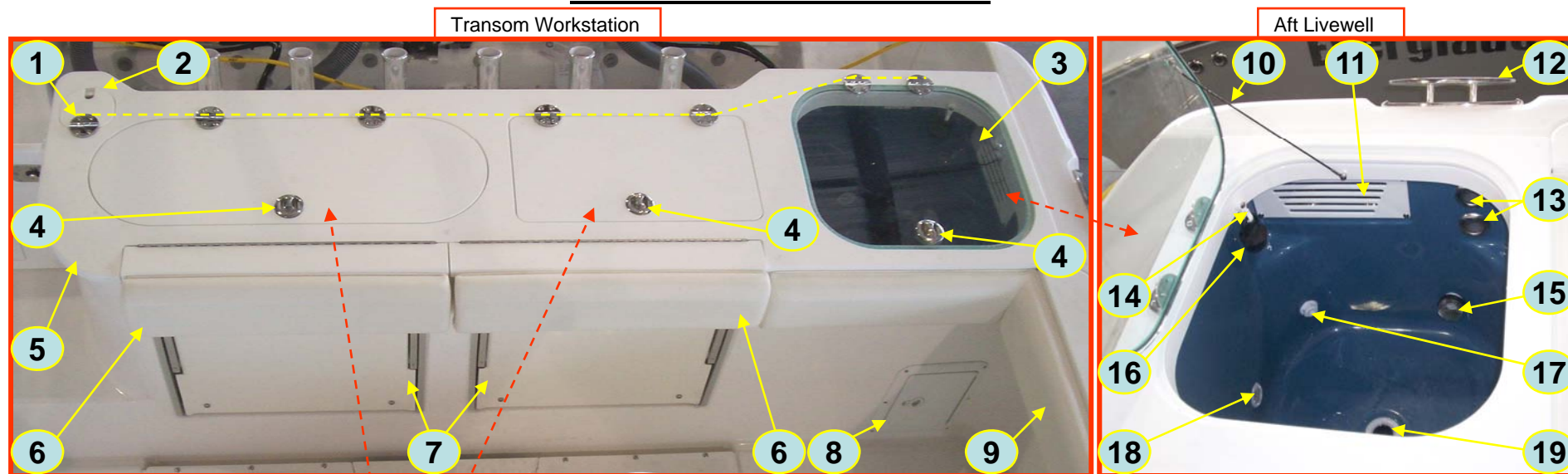

1. GEM:130200 – Round Two Hole Hinge
2. SeaTech:EC25201BX – Wash Down Coiled Hose 25'
3. Spartech:MIS – Transom Workstation Livewell Lid
4. Orcas:9121453 – Bridge Pull Slam Latch Non Locking
5. Spartech:350907 – Transom Workstation With Lids
6. Emerald Coast:EGS35-07-140-TB – Transom Backrest Cushion  
Orcas:9421192 – Magnetic Latch White Plastic Flush  
Emerald Coast:EGS35-07-135-LDJ – Jump Seat Bottom Cushion
7. RJAF:35-JUMPSEAT – Fold Down / Flip Up Jump Seat
8. DPI:DPF912 – 9" x 12" Door

9. Emerald Coast:EGS35-07-155-PCP – Port Coaming Pad
10. TH:DRS1 – 13" Door Restraint Stainless
11. Spartech:350925 – Livewell Drain Grate  
Orcas:9005246 – 1 1/2" Thru Hull Straight
12. GEM68301-ST – 10" Slim Line Pull Up Cleat
13. Orcas:9005257 – 1 1/8" x 90 Degree Thru Hull
14. Astrup:289280 – Tent Wall Hook White
15. TH:AS-1 – Screen / Strainer
16. TH:PP-150 – 1 1/2" Black Plug
17. TH:MAV-2KT – Max Air intake System
18. Innovative Light:012-5500-1 – Star LED White Livewell Light
19. Marine East:8060 – 1 1/2" Hose Barb x 1 1/2" MPT Angle Drain
20. Spartech:MIS – Transom Workstation Cooler Lid
21. Orcas:9005258 – 1 1/2" x 90 Degree Thru Hull
22. Dometic:259200051 – Refrigerator Thermostat
23. Spartech:MIS – Transom Workstation Cold Plate Lid
24. Dometic:RJ345-PM – Cold Plate / Refrigerator Complete Kit



## 350CC Transom Exterior Triple Engine

Exterior Transom and Motorwell

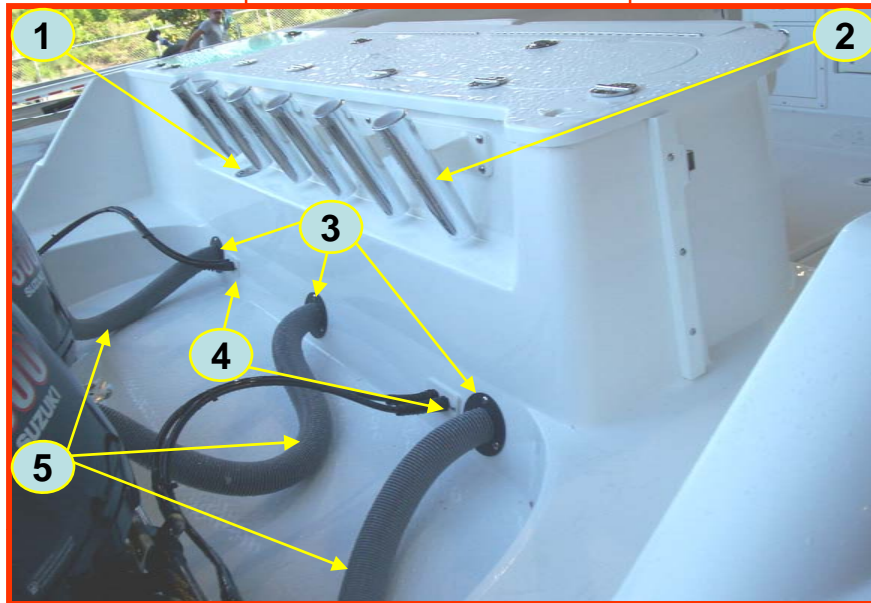

Aft Exterior Hull



Triple Engine Rigging

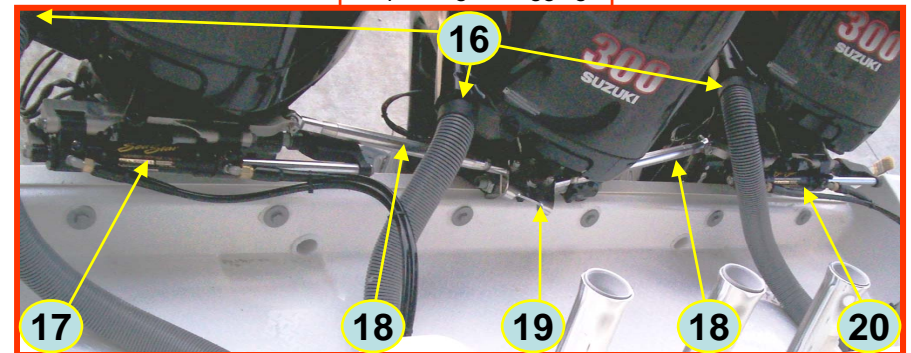

1. Orcas:8407016 – 1 ½" Water Fill Deck Plate Stainless
2. RJAF:35-TANSM-RODRACK – 350 Six Position Transom Rod Rack
3. MPI:747-2000 – 2" Black Transom Flange
4. RJAF:HYDRAU-PLATE – Transom Hydraulic Steering Line Plate
5. MPI:126-2000 – Gray Rigging Hose
6. Orcas:9107727 – 5/8" x 5" Stern Eye With Oval Plate
7. GEM:73101 – 1 ½" Motor Well Thru Hull
8. Garelick:19902-3601 – 3 Step Swim Ladder
9. Orcas:9024271 – 12" x 1" Grab Rail
10. RJAF:ENDCAP-S – Gunnel End Cap Starboard  
RJAF:ENDCAP-P – Gunnel End Cap Port
11. Abyss:600 – Underwater Light Stainless
12. Lectrotab:VKAS20X14/8315 – 14" x 20" Trim Tab
13. Suzuki:99105-0080L-215 – 3 x 16 x 21.5 Left Prop Stainless  
Honda:58333-ZY3-B17CL – 15 ¼" x 17 Left Prop Stainless
14. Suzuki:99105-00800-23P – 3 x 16 x 23 Right Prop Stainless  
Honda:58333-ZY3-A19CL – 15 ¼" x 19 Right Prop Stainless

15. Suzuki:99105-00800-215 – 3 x 16 x 21.5 – Right Prop Stainless  
Honda:58333-ZY3-A17CL – 15 ¼" x 17 Right Prop Stainless
16. Suzuki:67300-93J00 – Engine Rigging Grommet
17. Teleflex:HC6750 – O/B Cylinder Starboard
18. Teleflex:HO6700 – Tie Bar Kit
19. Teleflex:HA6701 – Tie Bar Kit Triple Engine
20. Teleflex:HC6751 – O/B Cylinder Port

## 350CC Transom Exterior Twin Engine

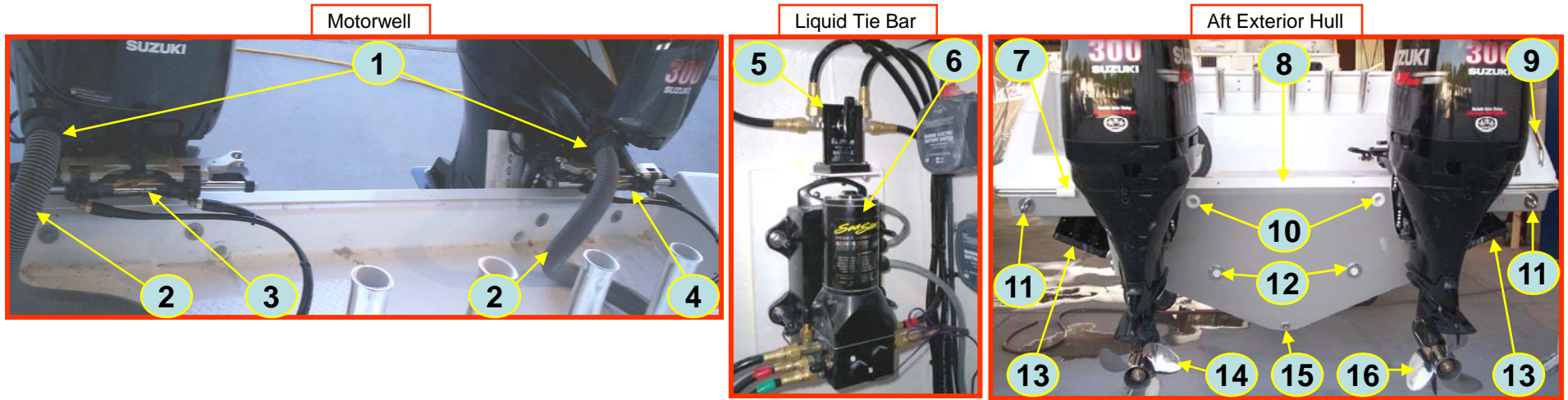

1. Suzuki:67300-93J00 – Engine Rigging Grommet
2. MPI:126-2000 – Gray Rigging Hose
3. Teleflex:HC6750 – O/B Cylinder Starboard
4. Teleflex:HC6751 – O/B Cylinder Port
5. Teleflex:HA5471-2 – Liquid Tie Bar Alignment Valve
6. Teleflex:PA12 – Power Assist Steering Pump 12v.
7. RJAF:ENDCAP-P – Gunnel End Cap Port  
RJAF:ENDCAP-S – Gunnel End Cap Starboard
8. RJAF:35-TRANSOM-MOLD – 350cc Transom Angle Mold
9. Orcas:9024271 – 12” x 1” Grab Rail

10. GEM:73101 – 1 ½” Motor Well Thru Hull
11. Orcas:9107727 – 5/8” x 5” Stern Eye With Oval Plate
12. Abyss:600 – Underwater Light Stainless
13. Lectrotab:VKAS20X14/8315 – 14” x 20” Trim Tab
14. Suzuki:99105-0080L-215 – 3 x 16 x 21.5 Left Prop Stainless  
Honda:58333-ZY3-B17CL – 15 ¼” x 17 Left Prop Stainless
15. Orcas:9004266 – Garboard Drain Oval
16. Suzuki:99105-00800-215 – 3 x 16 x 21.5 Right Prop Stainless  
Honda:58333-ZY3-A17CL – 15 ¼” x 17 Right Prop Stainless
17. Garelick:19902-3601 – 3 Step Swim Ladder

## 350CC Port Side Aft Bilge

Cold Plate Compressor

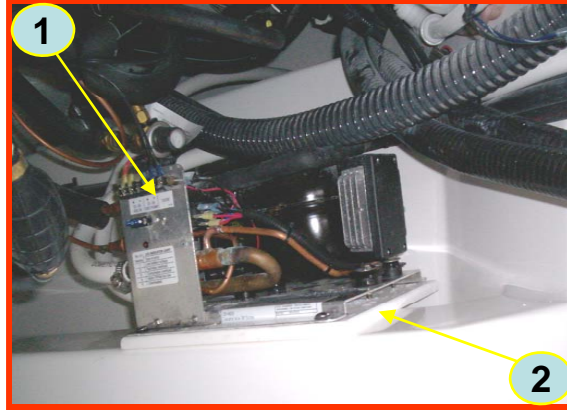

Raw Water Manifold

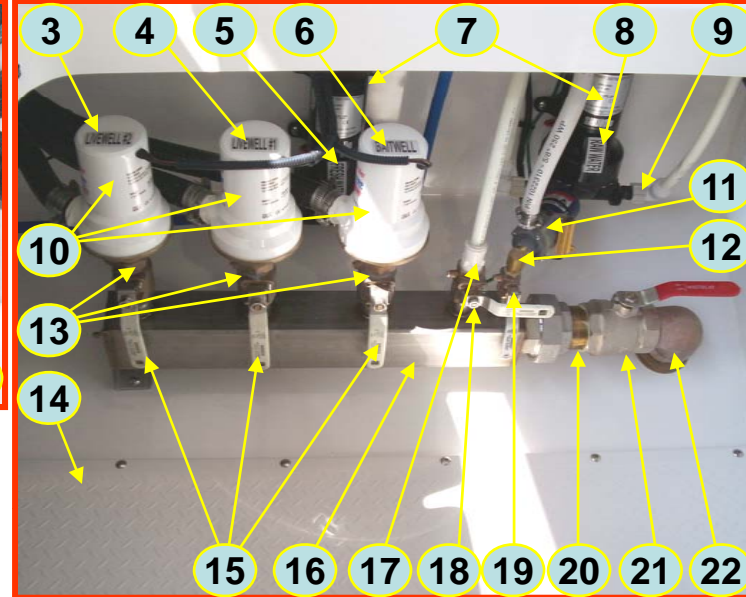

Fuel Water Separator

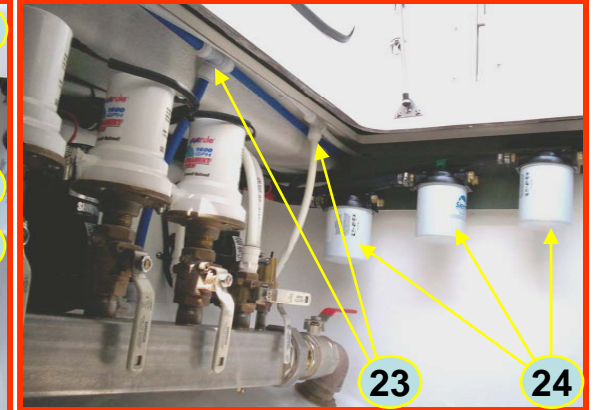

Aft Bilge Light

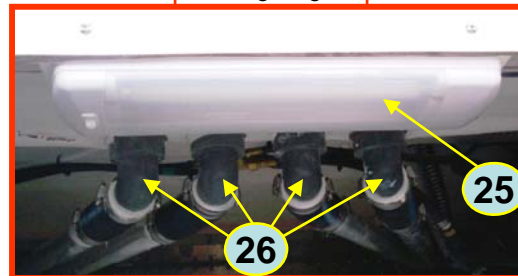

1. CruseAir:753000099 – Compressor From Cold Plate Kit
2. Spartech:280834 – Compressor Mounting Board
3. BCH:Livewell#2 – Livewell # 2 Label
4. BCH:Livewell#1 – Livewell # 1 Label
5. BCH:Fresh-Water – Fresh Water Label
6. BCH:Bait Well – Bait Well label
7. Shurflo:5901-0201 – Extreme Series Water Pump 5.7 GPM
8. BCH:Raw Water – Raw Water Label
9. SeaTech:2420-1008 – ½” Female Swivel Elbow
10. Jabsco Rule:209B – 1600 GPH Dual Port Livewell Pump
11. CruseAir:753000099 – Pump From Cold Plate Kit
12. All Florida:BRA28158 – 3/8” Brass Street ELL
13. All Florida:BRA40100 – 1” Brass Close Nipple
14. RJLM:35-BILGEFLOOR – 350cc Aft Bilge Floor
15. Groco:IBV1000 – 1” Ball Valve
16. RJAF:35-MANIFOLD – 350cc Water Intake Manifold
17. SeaTech:3501-1012 – 3/4” Male Connector
18. Groco:IBV750 – 3/4” Ball Valve
19. Groco:IBV375 – 3/8” Ball Valve
20. ACR:40-160 – 2” Bronze Nipple
21. Whitecap:P-5516 – 2” Ball Valve
22. ACR:44-168 – 2” Bronze Elbow
23. SeaTech:2423-10 – 1/2” Union Tee
24. Sierra:11878521 – Fuel Water Separator With Filter
25. BEP:005-394 – Florescent Bilge Light
26. Orcas:9305353-P – 2” x 90 Degree Plastic Adapter

## 350CC Starboard Side Aft Bilge

Power Management Enclosures



Engine Buss

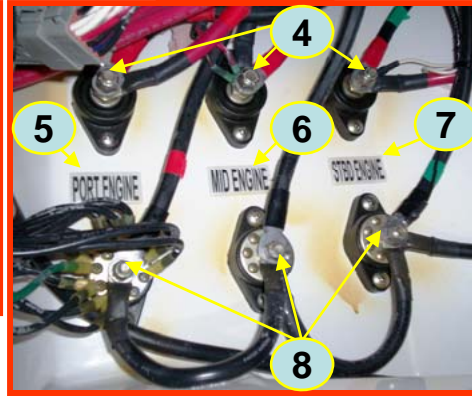

Aft Deck Drains

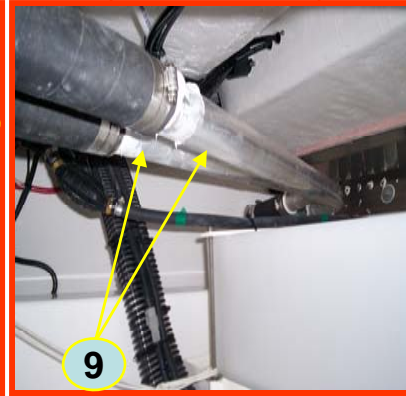

Aft Bilge

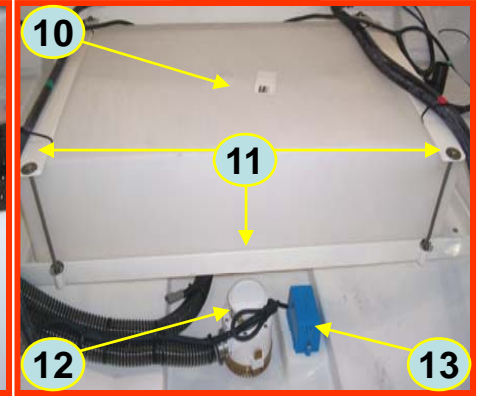

1. DNA:91YY6245-1 – Power Core 210 PME #1
2. DNA:91YY6246-1 – Power Core 210 PME #2
3. DNA:91YY6247-1 – Power Core 100 PME #3
4. Blue Sea:2003B – Single Post Buss 3/8" Stud
5. BCH:Port-Engine – Port Engine Label
6. BCH:Mid-Engine – Mid Engine Label
7. BCH:Stbd-Engine – Starboard Engine Label
8. Blue Sea:2102B – Single Post Buss 5/16" Stud W/ 8 Position Ground
9. RJAF:AFT-DECKDRAIN – 350cc 2" Aft Deck Drain Pipe
10. Elkhart:196-W – 35 Gallon Water Tank
11. RJAF:35-W-TANK-BRTK – 350cc Water Tank Securing Bracket
12. Jabsco Rule:13A – 3700 GPH Bilge Pump
13. MPI:900-1000 – Sure Bail Float Switch

## 350CC Teleflex Magic Bus Control

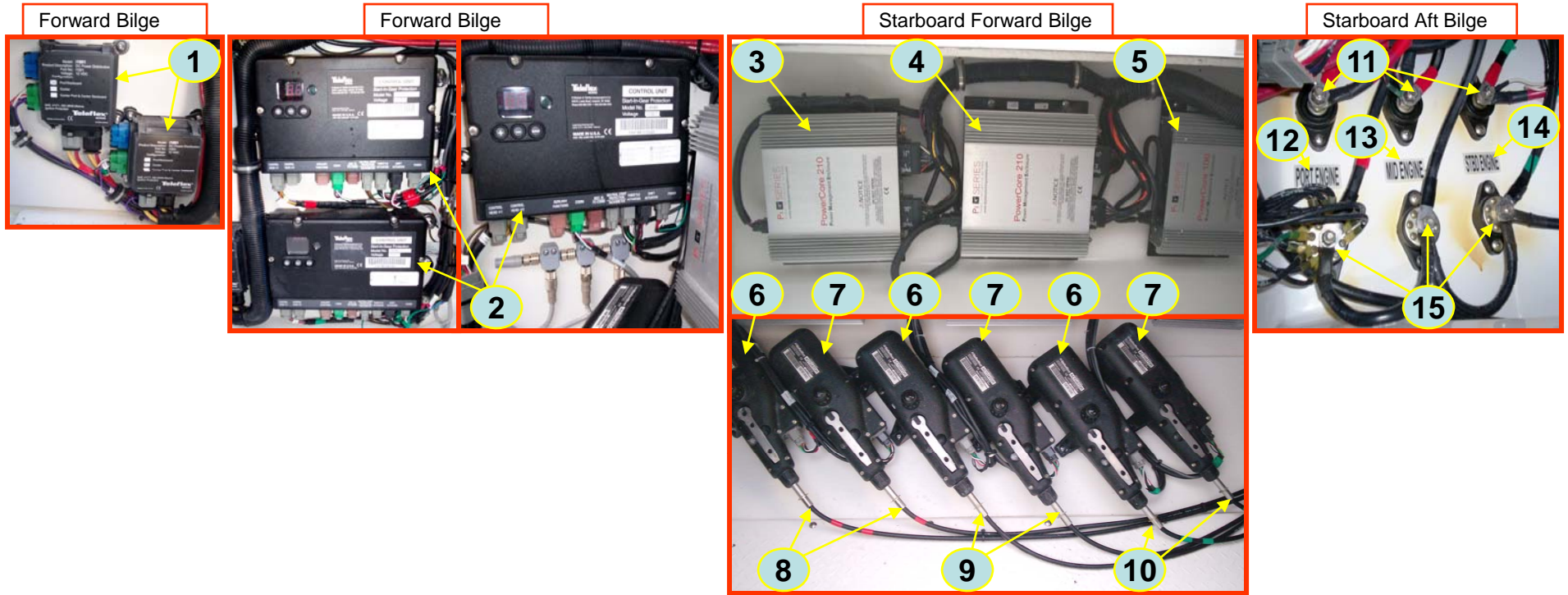

- |   |   |
|---|---|
| <ol style="list-style-type: none"> <li>1. Teleflex:I1001 – Relay Box Assembly</li> <li>2. Teleflex:EU64404 – Electrical Control Unit</li> <li>3. DNA:91YY6245-1 – Power Core 210 PME #1</li> <li>4. DNA:91YY6246-1 – Power Core 210 PME #2</li> <li>5. DNA:91YY6247-1 – Power Core 100 PME #3</li> <li>6. Teleflex:AC64021 – Throttle Actuator</li> <li>7. Teleflex:AC64023 – Shift Actuator</li> </ol> | <ol style="list-style-type: none"> <li>8. Teleflex:CC64814 – Cable ASM Actuator Hi Performance 14'</li> <li>9. Teleflex:CC64812 – Cable ASM Actuator Hi Performance 12'</li> <li>10. Teleflex:CC64810 – Cable ASM Actuator Hi Performance 10'</li> <li>11. Blue Sea:2003B – Single Post Buss 3/8" Stud</li> <li>12. BCH:Port-Engine – Port Engine Label</li> <li>13. BCH:Mid-Engine – Mid Engine Label</li> <li>14. BCH:Stbd-Engine – Starboard Engine Label</li> <li>15. Blue Sea:2102B – Single Post Buss 5/16" Stud W / 8 Position Ground</li> </ol> |
|---|---|

## 350CC Hull Exterior

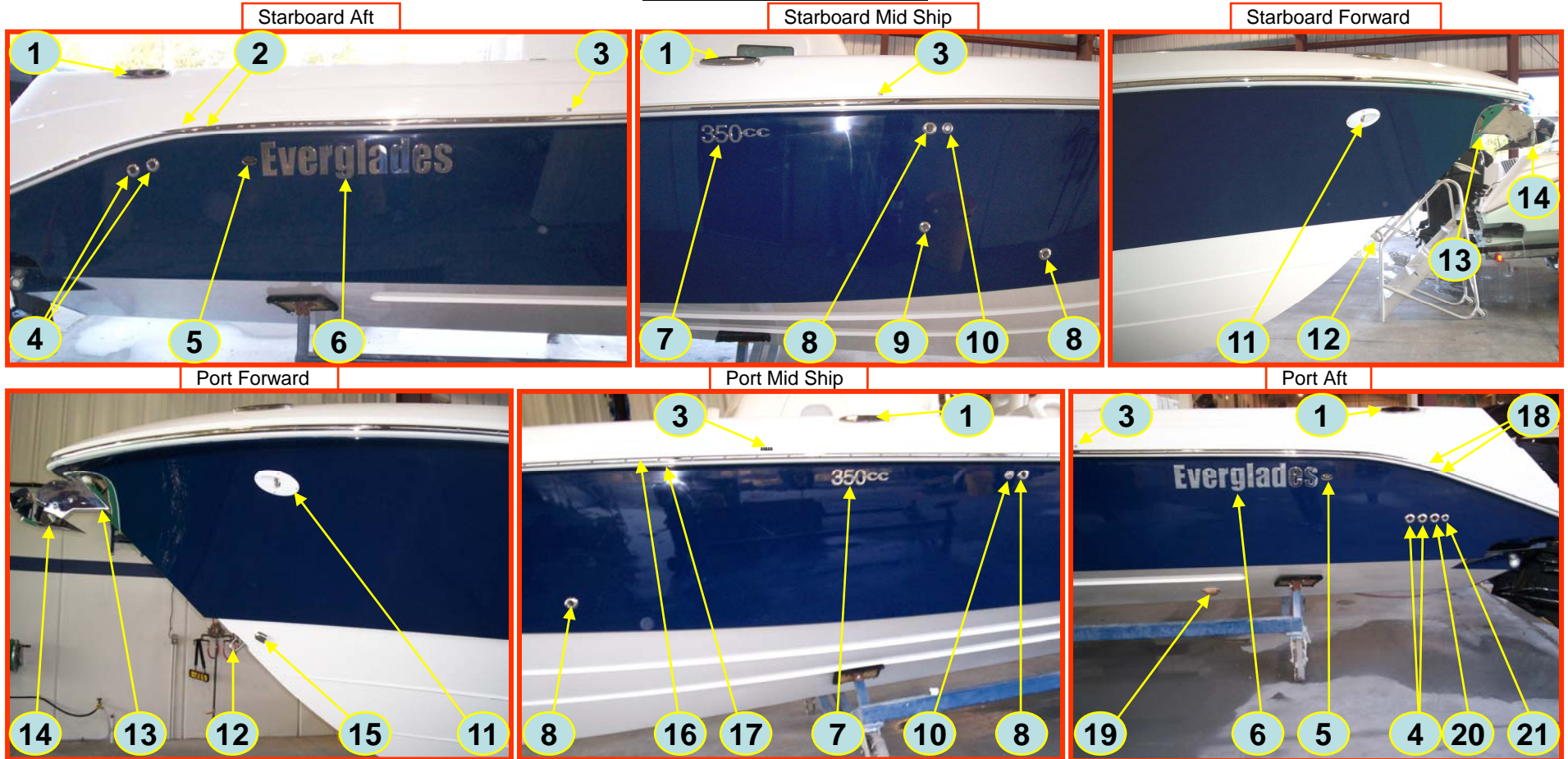

1. GEM:68301-ST – 10" Slim Line Pull Up Cleat
2. Taco:M16-4650-3-STBD – Stbd Molded Rub Rail W / Insert
3. BCH:SLING – Sling Label
4. Orcas:9005258 – 1 1/2" x 90 Degree Thru Hull
5. BCH:DS3 – Ram Cap Label
6. Douglas:EGL – Everglades Chrome Logo
7. Douglas:350CC – 350cc Chrome Logo
8. Orcas:9005257 – 1 1/8" x 90 Degree Thru Hull
9. Orcas:9105419 – 1" x 90 Degree Thru Hull
10. GEM:954 – 5/8" x 90 Degree Vent
11. Innovative Light:560-9901 – Docking Light W / White Cover

12. Epco:16-1500-0000 – 5/8" x 4" Bow Eye
13. Challenger:D35 – Bow Roller Hardware
14. Anchorlift:RSA-8 – Stainless Anchor ( Opt )
15. GEM:74005 – 1" Thru Hull Vent
16. Taco:S11-4650P16B – Stainless Insert
17. Taco:V21-9502WHC20D – Rub Rail White 20'
18. Taco:M16-4650-3-Port – Port Molded Rub Rail W / Insert
19. Groco:STH-2000W – 2" Intake Pick Up Strainer
20. Orcas:9005246 – 1 1/2" Thru Hull Straight Barb
21. Orcas:9005241 – 5/8" Thru hull Straight Barb
22. Orcas: 9205380 – 2" Thru Hull Scupper

Port / Starboard Trim Tab Well



23. Abyss:600 – Underwater Light Stainless

## Lewmar Pro Fish Windlass

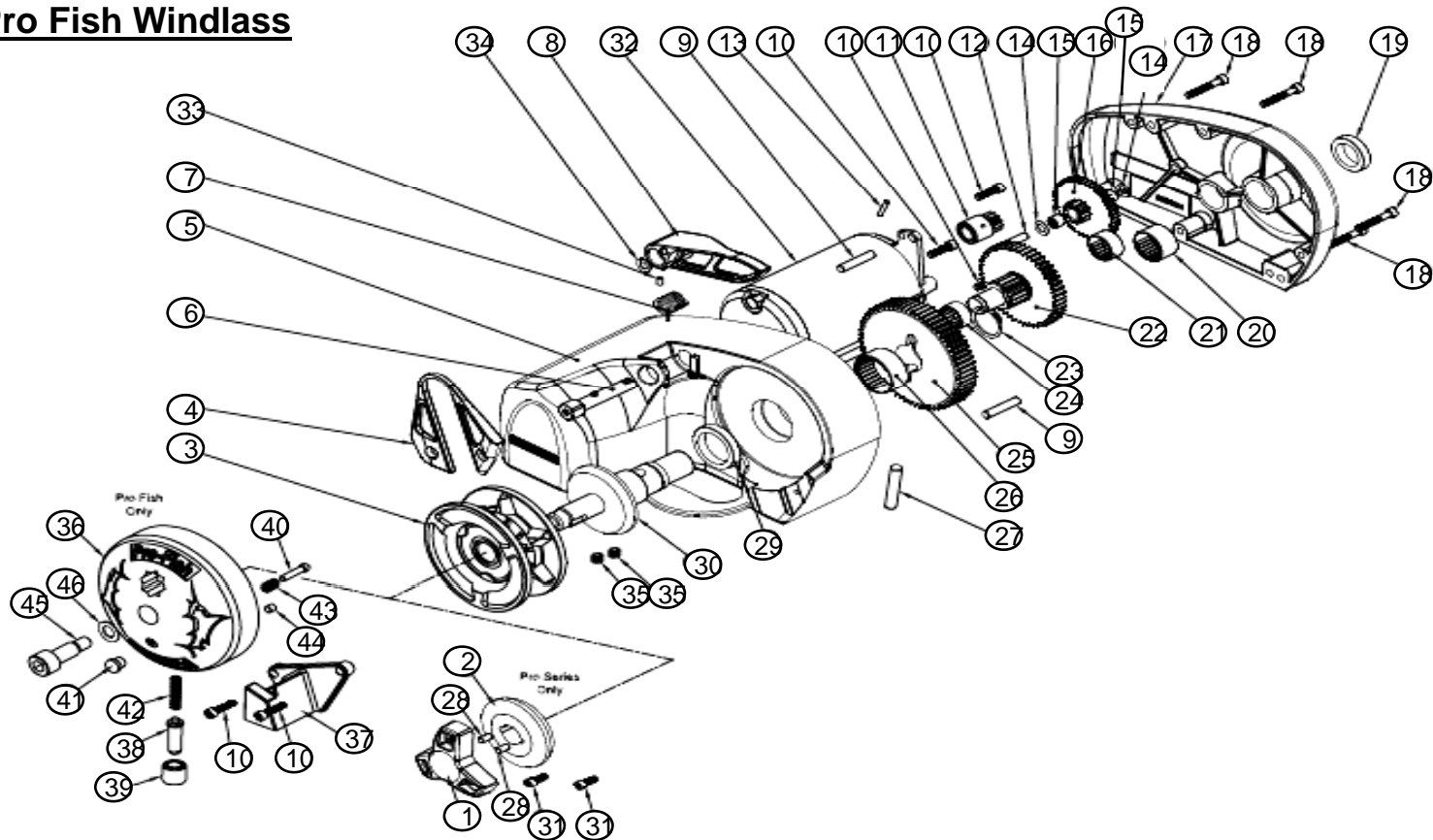

### 6.2 Pro-Series & Pro-Fish models 700 & 1000 service kits

Service Kit	Description	Items Included (Qty)
66000096	Pro-Series Stripper Arm Kit	4(1), 10(2), 31(2)
66000097	Control Arm Kit	6(1), 7(1), 8(1), 33(1), 34(1)
66000098	Pro-Series Clutch Nut & Cone Kit	1(1), 2(1), 28(2)
66000099	Clutch Lever	Clutch Lever (1)
66000100	Fastening Kit (Imperial)	47(1), 48a(1)
66000101	Gypsy RC 8 mm (5/16")	3a(1)
66000102	Gypsy RC 5/16" G4	3b(1)
66000103	Bearings Kit	15(20), 20(1), 21(1), 23(1), 24(1), 26(1)
66000104	Pro-Series Seals and Screw Kit	10(5), 12(1), 13(1), 18(6), 19(1), 23(1), 9(3), 27(1), 28(2), 29(1), 31(2)
66000105	Gears and Shaft Kit	11(1), 13(1), 14(2), 15(2), 16(1), 22(1), 23(1), 25(1), 27(1), 30(1)
66000106	Compound Gear Kit	22(1)
66000107	Motor 12 V	11(1), 32(1), 10(3), 12(1), 13(1), 35(2)
66000108	Fastening Kit (Metric)	47(1), 48b(1)
66000109	Gear Train Cover Kit	17(1), 18(6), 19(1), 20(1), 21(1)
66000110	Gypsy RC 7 mm (1/4")	3(1)
66000112	Gypsy RC 6 mm	3c(1)
66000616	Pro-Fish Conversion Kit	36(1), 37(1), 38(1), 39(1), 40(1), 41(1), 42(1), 43(1), 44(1), 45(1), 46(1), 10(2)
66000617	Pro-Fish Stopper Kit	37(1), 10(2)
66000620	Pro-Fish Drive Cap Assembly Kit	36(1), 38(1), 39(1), 40(1), 41(1), 42(1), 43(1), 44(1), 45(1), 46(1)

# 7. Troubleshooting

## 7.1 Anchor rode pays out independently while windlass is not in use

This problem is a result of not securing the anchor rode combined with the Clutch Nut (1) being slack. Tighten the clutch nut using the tool provided and always secure the anchor rode independently of the windlass whenever it is not being deployed or recovered.

## 7.2 Anchor rode pays out independently while windlass not in use (Pro-Fish)

This problem is a result of not securing the anchor rode combined with the internal Clutch mechanism not being fully engaged.

Operate the UP button briefly to fully re-engage the internal

clutch mechanism. Always secure the anchor rode independently of the windlass whenever it is not being deployed or recovered.

## 7.3 Electrical troubleshooting

As with most electrical marine equipment the majority of problems that arise are electrical in nature. Therefore it is essential that the proper voltage be maintained. The proper voltage on a 12 volt system is 13.5 volts. (Constant low voltage will destroy the motor). Ensure that electrical cable size is large enough to handle the current draw imposed upon it and to keep the voltage drop within acceptable limits. In any circumstance voltage drop due entirely to cable resistance should not exceed 10%.

Follow the charts to troubleshoot the problem.

Failure to Operate (Pro-Series 700 Only) Troubleshoot Chart: Reversing Toggle Control Switch (Part No. 0052519)	
Is there voltage at the input terminal (positive) to the control switch?	If no voltage is present, the battery isolation switch is OFF, the breaker is tripped or a fuse has blown. The battery may also have been dead or disconnected.
YES ↓ NO →	
Check voltage at the output terminals of the control switch with the switch on forward then reverse. Is there voltage at either output terminal for forward then reverse?	Control switch is defective.
YES ↓ NO →	
Replace motor.	
Sluggish Operation Troubleshoot Chart	
Is windlass overloaded?	Ease the load and ensure the battery is well charged.
YES ↓ NO →	
Check the voltage across the motor leads with the windlass on. (Proper voltage is 13.5 V. Constant low voltage will destroy the motor). Is the voltage low? (Below 11.0 V on a 12 V system).	There is a severe voltage drop in the circuit. Check for undersized cables, poor connections or corroded connections. Also check for resistance across the battery isolation switch or solenoid. (Feel them to see if they are heating up).
YES ↓ NO →	
Is the voltage correct? (Above 11.0 V and anchor is not fouled).	The motor is defective. Replace the motor.
YES →	
Failure to Operate Troubleshoot Chart	
Is there voltage at the input terminals to the contactor and switch(es)?	Check the circuit breaker/isolator switch and any fuses.
YES ↓ NO →	
Operate the switch. Is there voltage at the positive switch terminal on the solenoid?	The switch (or its wiring), is defective.
YES ↓ NO →	
Keep the switch activated. Is there voltage at the main output terminal on the contactor?	Check the contactor coil ground circuit. If okay, replace the contactor.
YES ↓ NO →	
Check the voltage at the motor. If voltage is present, the motor is defective. If you have any questions call your nearest Lewmar representative.	



## Shurflo Extreme Series Water Pump



<b>RV</b>	<b>PRODUCT SHEET</b>
OEM	5900-0201
Aftermarket	5900-0211

### TYPICAL APPLICATIONS

Multi-fixture potable water installations.  
Other uses may include 12 VDC pressurized water systems. This pump may be used for water transfer.  
For other applications, contact SHURflo.

### PUMP

Type	5 Chamber Diaphragm
Ports	Quick-Connect
Liquid	130 °F [54 °C] Max
Prime	9 feet [2.7 M]
Inlet PSI	30 PSI [2.1 Bar] Max
Run Dry	Yes
Fittings	1/2"-14 NASPT Dual O-ring included 1/2", 3/4" Barb available (straight & elbow)

### ELECTRICAL

Motor	12VDC Permanent Magnet, Intermittent Duty
Protection	Thermal Overload, Automatic Restart
Leads	14 AWG, 16" [40 cm] Red +, 13" [33 cm] Black -
Fuse	15 Amp Recommended
Control	Microprocessor PWM Pressure Transducer
Shut-Off	Voltage Variant, Factory Set at 65 PSI [4.4 Bar] @ 12 VDC ± 5 PSI [.4 Bar]

### MATERIALS

Housing	Nylon
Valves	EPDM
Diaphragm	Santoprene
Hardware	Stainless Steel

### APPROVALS

IAPMO, c-UL, CE

### LIMITED WARRANTY

3 Year Limited Warranty  
See SB-1041 & MS-030-123 For Details

### SHIPPING

Net Weight (Boxed)	8.8 Lb [4 Kg] each
Carton Weight	6 each, 53 Lb [24 Kg]
Carton Size	25"L x 20"W x 7"H [64cm x 51cm x 18cm]

### RELATED DOCUMENTS

Catalog	MS-030-083
Installation Manual	911-594
Maintenance	911-594
Applications Spec Guide	MS-020-005
Warranty	SB-1041/MS-030-123

### Extreme™ Smart Sensor 5.7



### Component Exploded View



### Parts Kits (now available)

#	Kit Description	Kit Number
2	Valve Assembly	94-030-01
3	Diaphragm/Drive Assembly	94-030-02
Fitting Kits with Clips		
	1/2" Elbow Barb (2)	94-615-00
	1/2" Straight Barb (2)	94-615-01
	3/4" Straight Barb (2)	94-615-04
	3/4" Elbow Barb (2)	94-615-05
	1/2"-14 NASPT (2)	94-615-06

## MOUNTING

- Mount pump within 6 feet of tank for best performance.
- Mount pump in a space of two cubic foot for adequate ventilation.
- The pump may be mounted in any position. If mounting the pump vertically, the pump head should face down.
- Choose a **solid** surface. **Do not insulate the baseplate heat sink.** Heat sink must be free and have air flowing across.
- Do not over-tighten mounting feet.

## ELECTRICAL

**CAUTION** RED PUMP WIRE MUST BE CONNECTED TO POSITIVE POWER OR CONTROLLER WILL BE DAMAGED!!!

- The pump should be on an individual circuit, protected by the specified size fuse or circuit breaker on the label.
  - A 15 amp or higher switch is recommended, and must be on the positive (+ red) lead.
  - **TEST INCOMING POWER WITH MULTIMETER TO TEST POLARITY ( RED = + and BLACK = - ).**
  - Pump draws 15 millamps when pump is powered on, even when the pump is not running.
- SHUT OFF POWER TO PUMP WHEN LEAVING COACH.**

Wire Size for a10% voltage drop on a 12VDC, 15 Amp Circuit	
Length is distance from power source to pump and back to ground	
0-20 Ft [0-6M]	= 14GA [2.5mm <sup>2</sup> ]
20-50 Ft [5-15M]	= 12GA [4mm <sup>2</sup> ]
50-70 Ft [15-20M]	= 10GA [6mm <sup>2</sup> ]
70-100 Ft [21-30M]	= 8GA [10mm <sup>2</sup> ]

**Electrical Connection with 10 Amp or 15 Amp Controller**  
Disconnect wires from current pump and connect to Smart Sensor Pump. Make sure wires are at least 14GA [2.5mm<sup>2</sup>].

**Electrical Hook-Up with 7Amp Intellitac Controller**  
Replace 7 Amp controller with 10 Amp or 15 Amp Controller, or install relay as shown below. The purpose of the relay is to allow the 7 amp controller to close the circuit on the relay allowing a higher amp circuit to run the pump. Common name for the relay is a Bosch 30-Amp automotive-type relay. Turn off all power before electrical work.

### Relay Installation

1. Splice 2 red wires into the incoming power line to +12V.
2. Connect one red wire to the red fused pump wire.
3. Connect one red wire to relay terminal 85.
4. Remove wire from the controller LOAD terminal to the black (-) pump wire and connect it to relay terminal 87.
5. Make a jumper wire from LOAD to relay terminal 86.
6. Splice ground wire from relay terminal 30 to controller GND terminal and circuit ground.
7. Leave wire to SW terminal connected to switches.

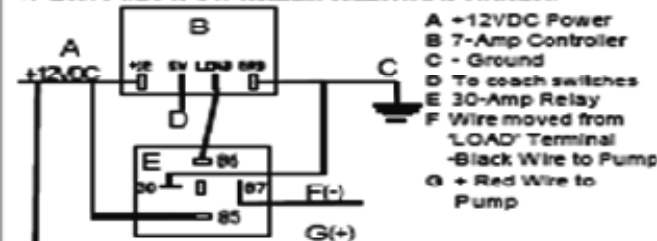

## PLUMBING

- Installation of a strainer (SHURflo model 254 or larger) is required to prevent debris from entering the pump.
- For noise and vibration reduction we recommend at least 18 in. [4.5M] of 1/2" [13mm] I.D. flexible high-pressure tubing to both ports. The pump ports and strainer *should not* be connected to plastic or rigid pipe.
- SHURflo quick-connect fittings provide easy installation and removal if required. The fittings are designed with dual o-rings, creating a seal when snapped into place. Lubricate o-rings with silicone-based grease.
- **NOTE: Remove clips completely from pump during maintenance and storage to avoid distortion.**

### To Insert Fittings:

1. Hold fitting with 3/4" wrench and tighten plumbing to fitting.
2. Make sure o-rings are lubricated
3. Insert fitting into quick-connect port.
4. Snap lock clip over fitting and lock tab with 'fitting' facing out toward fitting.

### To Remove Fittings:

1. Pry up edge of lock clip over lock tab one at a time.
2. Remove clip and slide fitting out of port. Fully install clips or remove completely during maintenance and storage.



## TROUBLESHOOTING & MAINTENANCE

Regularly check all fittings/screws/connections  
**PUMP WILL NOT START/ BLOWS CIRCUIT**

- ✓ Electrical connections, fuse, breaker, main switch, and ground connection.
- ✓ Is the motor hot? Self-resetting thermal breaker may have tripped.
- ✓ **WILL NOT PRIME/SPUTTERS** (No discharge/Motor runs)
- ✓ Is the strainer clogged with debris?
- ✓ Is there water in the tank, or air in the hot water heater?
- ✓ Is the inlet plumbing sucking in air at connections (vacuum leak)?
- ✓ Is inlet/outlet plumbing severely restricted or kinked?

**PUMP WILL NOT SHUT OFF/RUNS WHEN FAUCET IS CLOSED**

- ✓ Output side plumbing for leaks, and inspect for leaky valves or toilet.
- ✓ For air trapped in outlet side (water heater) or pump head.

### NOISY OR ROUGH OPERATION

- ✓ For plumbing which may have vibrated loose.
- ✓ Is pump plumbed with rigid pipe?
- ✓ Does the mounting surface amplify noise?
- ✓ For mounting feet that are loose or compressed too tight.
- ✓ For air in system.

**Sanitizing:** SHURflo recommends sanitizing your system every year or as needed for maintenance. Follow your manufacturer's recommended procedures.

**Winterizing:** Follow your manufacturer's recommendations. Do not allow water to freeze in the pump or strainer.

## LIMITED WARRANTY

SHURflo warrants The Extreme series RV pump to be free from material and workmanship defects under normal use and service for a period of (3) three years from the date of purchase. In the absence of proof of purchase the warranty is (3) three years from the date of manufacture indicated on the motor nameplate. SHURflo is not responsible nor will it reimburse for labor necessary to remove and reinstall a pump, if found defective. Contact SHURflo for complete Limited Warranty details.



**SHURflo**  
First to Field Innovations

SHURflo reserves the right to update specifications, prices, or make substitutions

SHURflo -  
3900a, Easton Ave  
Corona, CA 92620  
(951)934-2228  
(951)934-2228  
FAX: (951) 934-2228

SHURflo -  
22541 Park Blvd Court  
Bakersfield, CA 93311-0427  
(815)710-3004  
(815)710-3004  
FAX: (815) 710-3004  
www.shurflo.com

© 2004 SHURflo Inc.

SHURflo at  
The T. Sailing Dock  
Oceanside, CA 92054  
The Beach, 3000 21st  
Street, Escondido  
Tel: (760) 225-0000  
FAX: 760 225-0000

## Teleflex Liquid Tie Bar Realignment ( Twin Engine )

### Realignment Instructions

Engines toed outwards: Props too far apart

Front Mount Cylinder

Side Mount Cylinder

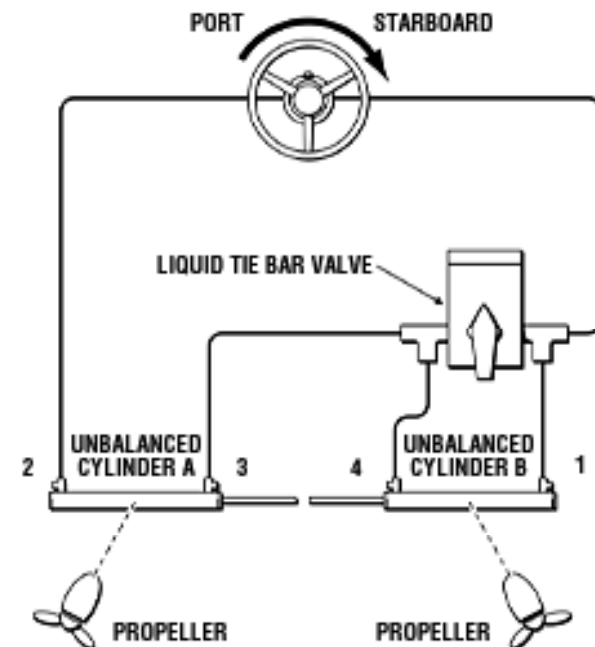
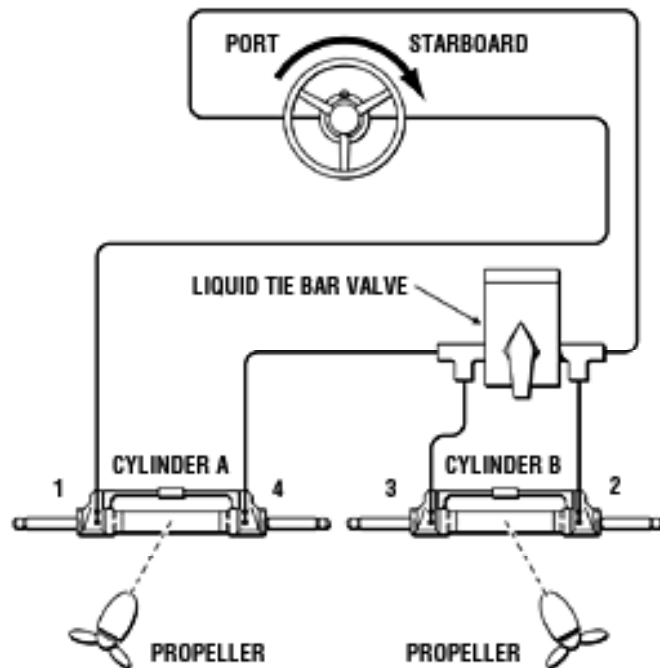

1. Turn the wheel hard over to Starboard. (Both cylinders move; cylinder B reaches hard over first)
2. Open the valve
3. Continue to turn the wheel hard over to Starboard. (Only cylinder A moves and reaches hard over)
4. Close the valve

## Teleflex Liquid Tie Bar Realignment ( Twin Engine )

Engines toed inwards: Props too close together

Front Mount Cylinder

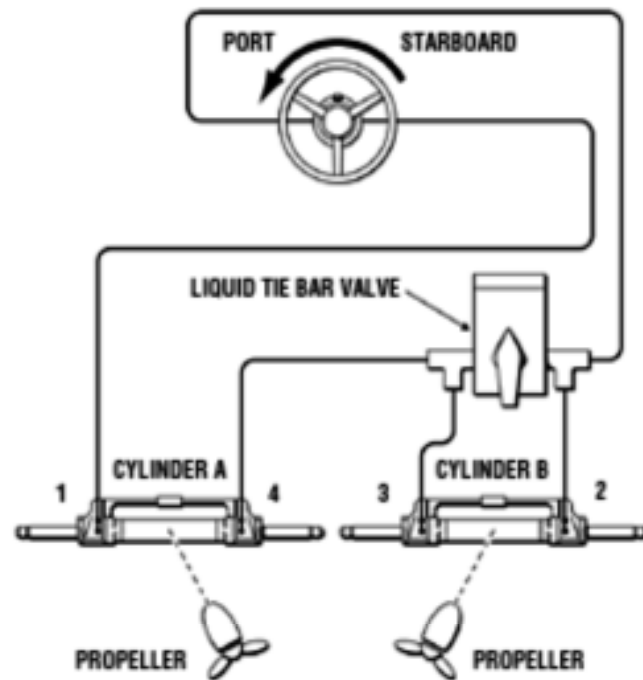

Side Mount Cylinder

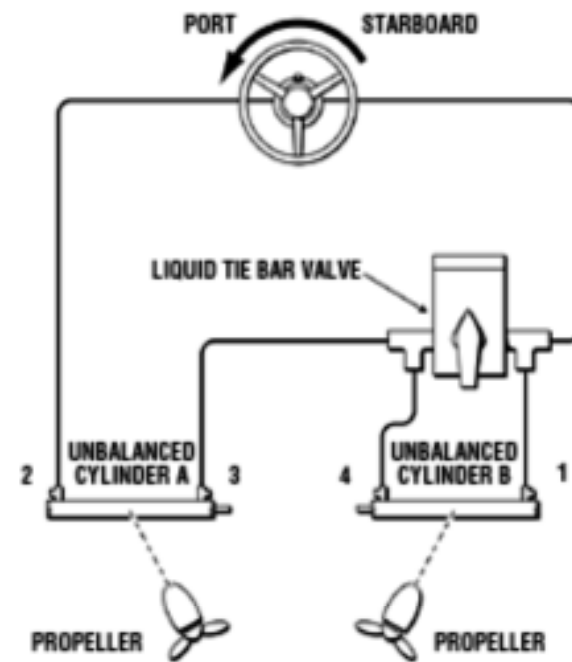

1. Turn the wheel hard over to Port. (Both cylinders move; cylinder B reaches hard over first)
2. Open the valve
3. Continue to turn the wheel hard over to Port. (Only cylinder A moves and reaches hard over)
4. Close the valve

# Pro Tournament Battery Charger

## Troubleshooting

12

### ▶ Trouble Shooting Guide

#### No Red or Green LED Indicator

Check for loss of AC power at the 120VAC Outlet. Confirm GFCI (Ground Fault Circuit Interrupter) has not tripped. Check with a meter or 120VAC test light that AC is present at the end or your extension cord.

Confirm all charger cables are installed with the correct polarity connections at each battery and that all connections are clean and tight.

With the AC power removed and the engine off check the charge level of each battery with on-board "Push-to-Test" feature as described on page 5. If there is no charge level indication for a battery, check each battery with a hydrometer to determine if it has one or more bad cells. (batteries should always be replaced in sets, and always the same type.)

If everything above checks out ok, contact ProMariner for product service.

#### Battery is Not Charging, Red and Green Indicator is "on"

Confirm all charger cables are installed with the correct polarity connections at each battery, and that all connections are clean and tight. *Reverse polarity connections will blow output fuse, resulting in no output voltage.*

With the charger on, read DC Voltage at each battery. If any of the readings are less than 13.0VDC Proceed with the following:

A. Disconnect AC power at the 120VAC outlet.

B. Remove charger cables from each battery.

C. Reconnect AC power and read DC Voltage across each output cable, if output voltage is approximately 14.5VDC the charger is ok and each battery should be tested with a hydrometer with the charger and engine off to determine if one or more batteries have bad cells. (batteries should always be replaced in sets, and always the same type.)

D. If there is no output when trying to read DC voltage check each output fuse and replace as needed.

If the DC voltage at each charger output there is less than 14.0 volts contact ProMariner for product service.

## Maintenance

11

### ▶ Owner's Periodic Maintenance Guide

#### Item: Battery Connections

**Process:** Clean and tighten all battery connections. Follow battery manufacturer's instructions for cleaning a battery. Clean all battery terminals with a wire brush where required and tighten all battery connections.

**When:** Monthly

#### Item: Battery Electrolyte

**Process:** Per battery manufactures instructions monitor and maintain proper levels of distilled water in each battery.

**When:** Monthly

#### Item: ProTournament DC Output Wiring

**Process:** Visually inspect all wiring for cuts and abrasions. Contact ProMariner if charger needs to be serviced with new wiring.

**When:** Monthly

#### Item: AC Power Cord and Mounting Hardware Inspection

**Process:** Visually inspect the AC power cord. Confirm ground blade is present and all plug blades are in good conditions and not bent out of place.

Check all mounting hardware to ensure there is no loose hardware. Tighten were required.

**When:** Monthly

ProMariner®

ProTournament Series  
Owner's Manual and Installation Guide



Distributed On-Demand 3 Step Charging  
Professional Grade 3 Step Marine Battery Chargers