

# 290 Pilot

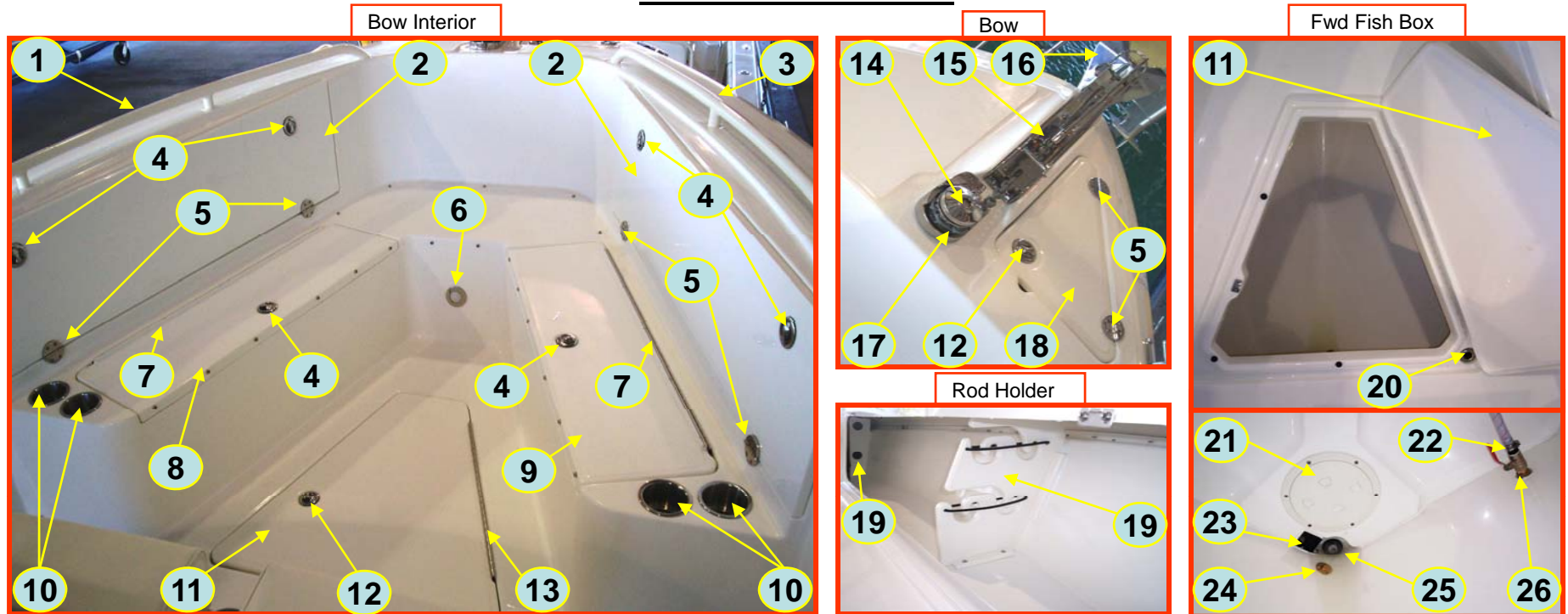

**Everglades**  
*by Dougherty*

## 290Pilot Bow Interior



- |  |   |
|--|---|
| <ol style="list-style-type: none"> <li>1. RJAF:290-BOWRAIL-P – Port Bow Rail</li> <li>2. Spartech:280813 – Rod Locker Doors Port and Stbd (Set)</li> <li>3. RJAF:290-BOWRAIL-S – Stbd Bow Rail</li> <li>4. Orcas:9121455 – Bridge Latch Locking</li> <li>5. GEM:130200 – Round Hinge Two Hole</li> <li>6. ITC:69650-ss – White / Red LED Light</li> <li>7. Jefco:12239 – 38: x 2” Off Set Hinge</li> <li>8. New Boston:PRL-29-4 – Port Rod Locker Door</li> <li>9. New Boston:STB-29-5 – Stbd Rod Locker Door</li> <li>10. RDI:1006RDI – Stainless Cup Holder</li> <li>11. New Boston:FFL-29-3 – Fwd Floor Locker Door</li> <li>12. Orcas:9121453 – Bridge Latch Non Locking</li> <li>13. Jefco:12281 – 24” x 2” Flat Hinge</li> </ol> | <ol style="list-style-type: none"> <li>14. Anchorlift:C-612 – Windlass 600 series 12v. Barracuda</li> <li>15. Challenger:BR260290 – Bow Roller Stainless</li> <li>16. Anchorlift:RSA-8 – Stainless Anchor (opt)<br/>Anchorlift:SA-8 – Galvanized Anchor 17.5lb.</li> <li>17. Anchorlift:2007RC-200 – Rope Chain Combo W/Swivel</li> <li>18. New Boston:AL-29-2 – Anchor Lid</li> <li>19. Teak Isle:290824 – Rod Rack Set</li> <li>20. Orcas:9005256 – Thru Hull 90 Degree x ¾” Barb</li> <li>21. Beckson:DP82-WP – 8” Twist Out Deck Plate</li> <li>22. Marine East:8002 – ¾” Barb x ¾” Pipe Thread</li> <li>23. Touch Sensor:100600028 – Float Switch</li> <li>24. Whitecap:S-5051 – Brass Garboard Drain</li> <li>25. TH:AS-1 Screen/Strainer</li> <li>26. Whitecap:P-5512 – ¾” Brass Ball Valve</li> <li>27. Jabsco/Rule:403CDM – 800GPH Angle Pump W/Connector</li> </ol> |
|--|---|

## 290Pilot Console

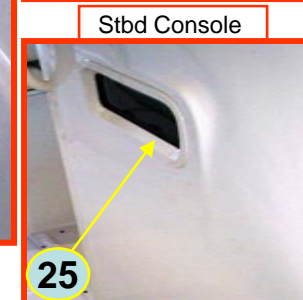
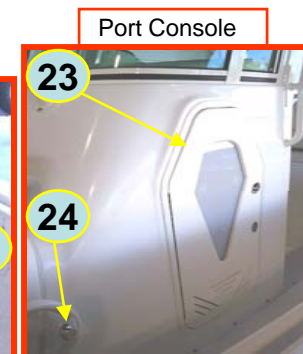
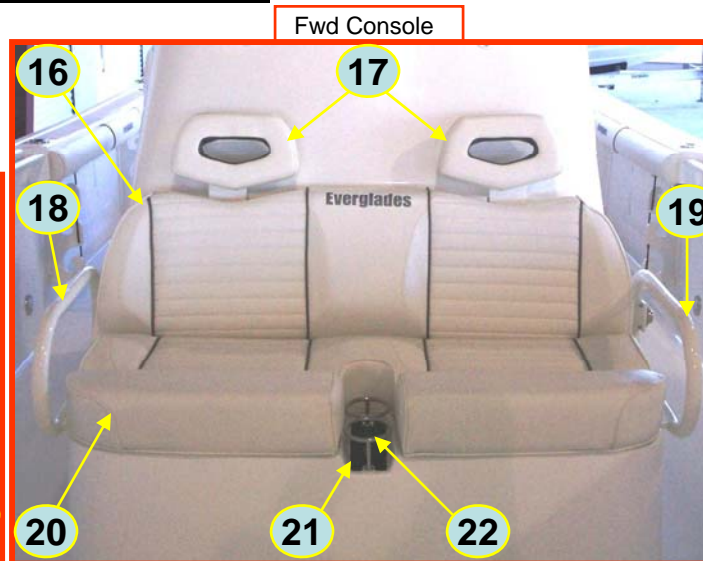
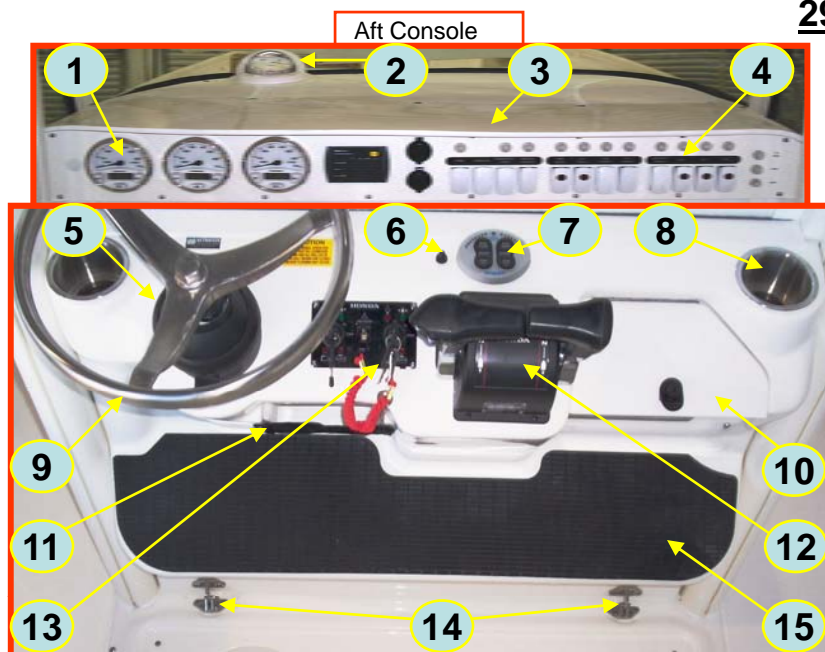

1. Suzuki:990C0-86W30 – Tach/Speed Multi Function Gauge Set  
Honda:06375-ZY3-800 – Tachometer Gauge  
Honda:06373-ZY3-800 – Speedometer Gauge
2. Ritchie:HF-743W – Front Read White Compass
3. Spartech:280808 – Dash Visor
4. BH:242-04762-P – Dash Switch Panel
5. Uflex:UP28T – 1.77 Tilt Helm Hydraulic  
Uflex:X52 – Tilt Mechanism
6. Pacer:ETS658-20WH – 20Amp. Push Button Breaker  
Pacer:ES-PBCVR-BK – Breaker Boot Black
7. Linear:SETR-50 – Trim Tab Switch Oval
8. RDI:1006RDI – Stainless Cup Holder
9. GEM:155106 – 15" 3-Spoked Wheel Brushed
10. Spartech:280802 – Glove Box
11. Obeco:RJ87BSHCBH – Black Net
12. Suzuki:67000-93J10 – Dual Binnacle  
Honda:06240-ZW5-U60 – Dual Binnacke

13. Suzuki: Suzuki:37100-96J10 – Dual Ignition start stop Switch  
Honda:35552-ZW7-025AH – Dual Ignition Start Stop Switch
14. Orcas:8631408 – Motor Box Hinge
15. Sano:RJFOOTREST – Tread Mat
16. Emerald Coast:2907103 – Fwd Console Seat Back
17. Emerald Coast:2907105 – Headrest Cushion
18. RJAF:290-FCRAIL-S – Stbd Fwd Console Seat Rail
19. RJAF:290-FCRAIL-P – Port Fwd Console Seat Rail
20. Emerald Coast:2907104 – Fwd Console Seat Bottom
21. Sano:RJCUPHOLDER – Drink Holder Treat Mat
22. King Marine:88004 – Dual Cup Holder Stainless
23. Teak Isle:22-19956 – Console Head Door W / Latch
24. Orcas:9121390 – Magnetic Latch
25. Bomar:NC2414-THCK – Port Window White
26. Miller Bearing:01-D012-0050-A08-LN – Security Shield Actuator 12v.

## 290Pilot Head Interior

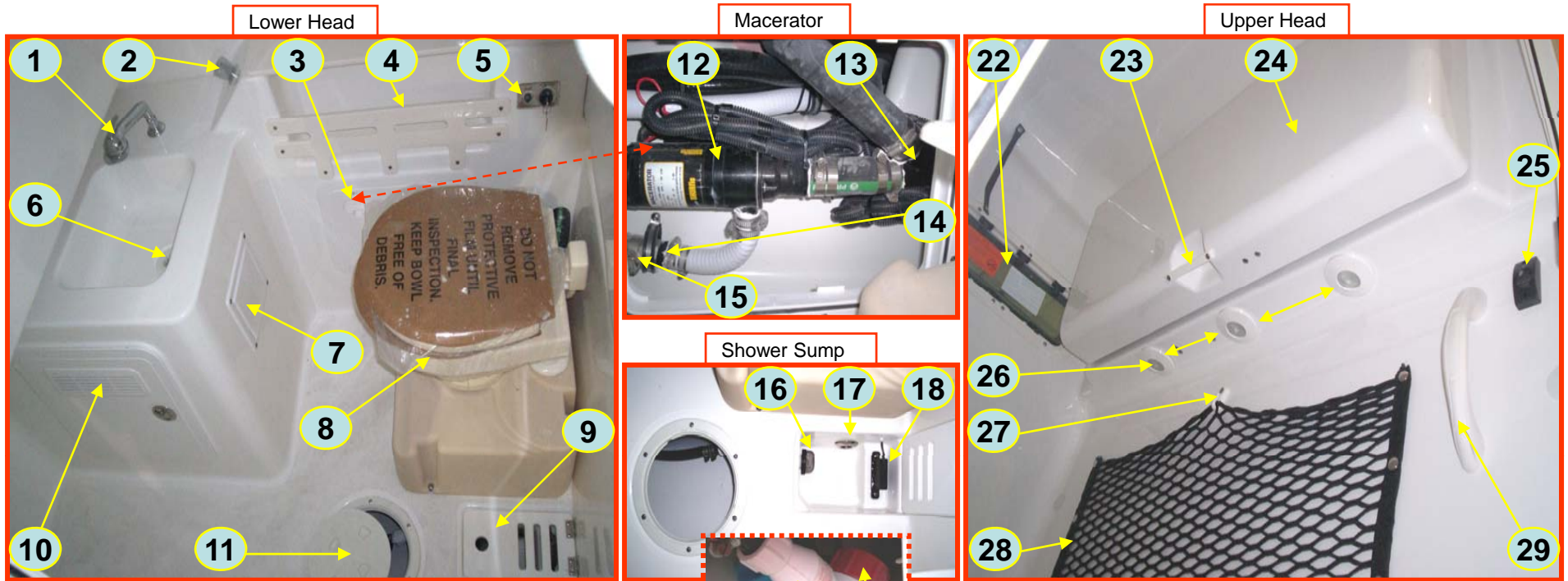

1. Shurflo:134-008-CP – Shower Unit / Faucet
2. Shurflo:136-0204-CP – Shower Valve
3. Innovative Product:M-1216APPW – 12" x 16" Access Panel
4. Teak Isle:290814 – Vanity Rail
5. Sierra:MP-41030 – Ignition Switch
6. Marine East:6324W – 1 1/8" x 90 Degree Drain
7. SSI:30800000 – Recessed Toilet Paper Holder
8. SeaLand:371103 – Sanitation System Model 711-M28
9. Spartech:280815 – Sump Cover  
Spartech:280832 – Head Step (Not Shown)
10. Innovative Product:MISC-1618LS – 16" x 18" Left Swing Door
11. Beckson:DP82-WP – 8" Twist Out Deck Plate
12. Shurflo:3200-000 – Macerator Pump
13. Whale:YP6114 – 1 1/2" Y-Fitting
14. Marine East: 8002 – 3/4" x 3/4" Hose Barb
15. Whitecap:P-5513 – 1" Ball Valve

16. TH:AS-1 – Screen / Strainer
17. Orcas:9005256 – 3/4" x 90 Degree Thru Hull
18. Johnson Pump:100600028 – Float Switch
19. MPI:900-1000 – Sure Bail Float Switch
20. All Florida:100-107 – 3/4" Check Valve
21. Jabsco Rule:403CDM – 800 GPH Angle Pump
22. Bomar:NC-2414-THCK – Port Window White
23. RJAF:290-E-HANDLE – Electronics access Door Handle
24. RJLM:290-E-DOOR – Electronics Access Door
25. BEP:1100-BK – Micro Modular Switch
26. BEP:001-124 – Round Interior Light
27. Astrup:289280 – Tent Hook
28. Obeco:RJ1533BSHCSS – Black Stretch Net 15" x 33"
29. Attwood:2050-1 – Vinyl Grab Handle

## 290Pilot Hardtop

Fwd Hard Top Exterior

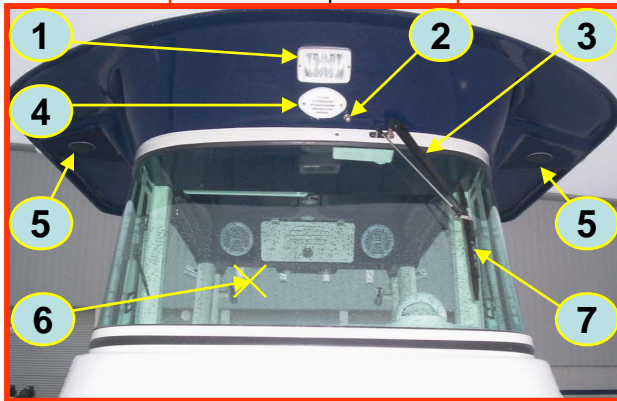

Aft Hard Top Exterior

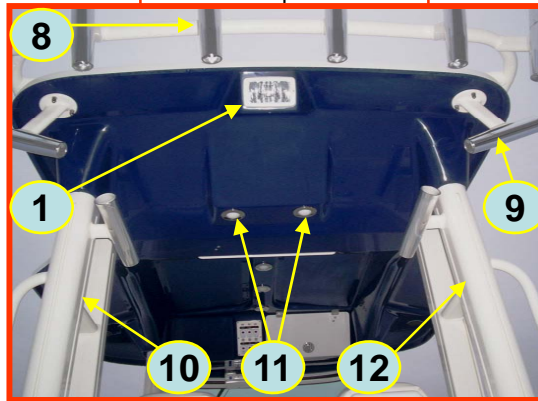

Fwd Hard Top Interior

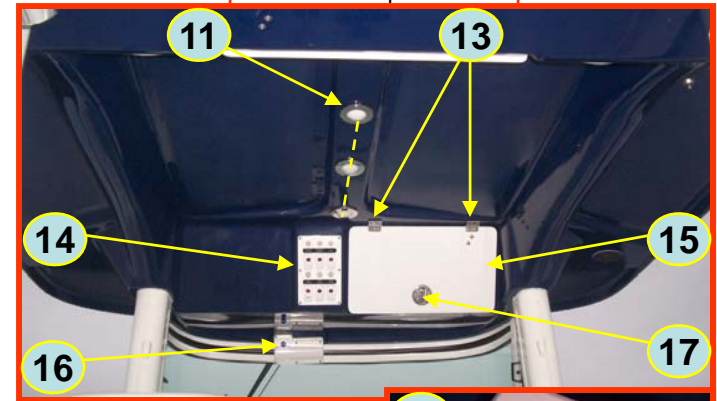

Aft Hard Top Interior

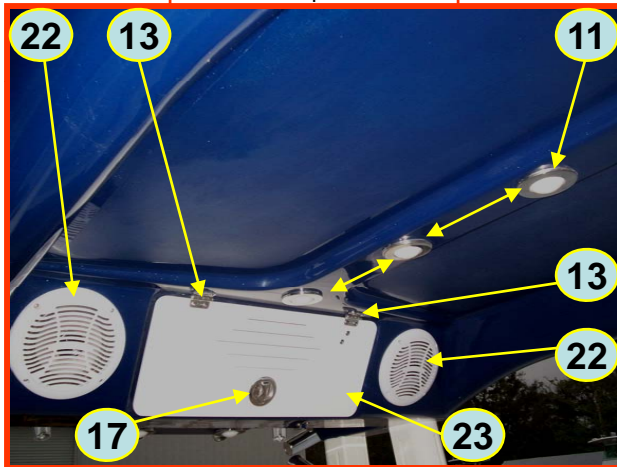

Anchor Light



Nav Light



- |  |  |
|--|--|
| <ol style="list-style-type: none"> <li>1. BEP:ML-005NWW – Flush Mount Flood Light</li> <li>2. Alta:AF-066001 – Spray Head Nozzle</li> <li>3. Ongaro:39153 – Wiper Arm 14"</li> <li>4. Marinco:11187 – Horn Cover White<br/>Marinco:11080 – Drop In Horn</li> <li>5. Taco:F403125-BKA – Black Outrigger Plug</li> <li>6. Taylor:885004000202 – Front Windshield<br/>Taylor:885004000306 – Port/Stbd Side Shield Wing</li> <li>7. Ongaro:30514 – Wiper Blade 14"</li> <li>8. RJAF:P-RODHOLDER – Pilot Aft Rod Holders</li> <li>9. RJAF:KINGFISH – King Fish Rod Holder</li> <li>10. RJAF:AFT-HT-P – Port Aft Hard Top Support</li> <li>11. ITC:69650-SS – Red/White Combination Light</li> <li>12. RJAF:AFT-HT-S – Stbd Aft Hard Top Support</li> <li>13. GEM:1172 – Butt Hinge</li> </ol> | <ol style="list-style-type: none"> <li>14. BH:245-04626-P – Hard Top Switch Panel</li> <li>15. Spartech:280811 – Fwd Electronics Box Door</li> <li>16. Ongaro:34002 – Water Proof Wiper</li> <li>17. Orcas:9121455 – Bridge Latch Locking</li> <li>18. Orcas:8921212-2 – 2mm. Latch Spacer</li> <li>19. SPD:BRX-1096SS – Two Hole 90 Degree Bracket</li> <li>20. Ameritool MFG:625-3-20 – 10 1/4" x 20lb. Gas spring</li> <li>21. TrimLok:3100BX1/4A – Trimlock Black on Black</li> <li>22. ASA:AMS-602W – 6.5" White Speaker</li> <li>23. Spartech:280810 – Aft Hard Top Door W/Vents</li> <li>24. Orcas:9402530 – 40" Anchor Light W/ Swivel</li> <li>25. Innovative Light:554-3100 – Port Nav Light<br/>Innovative Light:554-2100 – Stbd Nav Light</li> <li>26. ECI:664-2207 – Solenoid Valve 12v.</li> </ol> |
|--|--|



## 290Pilot Helm Seat

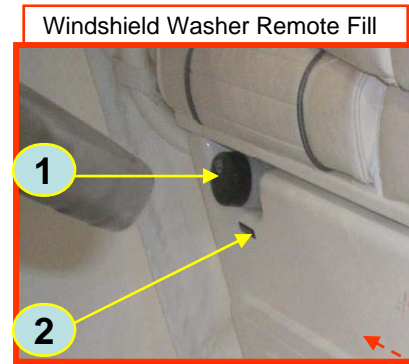

Windshield Washer Remote Fill



Stbd Fwd Seat Storage

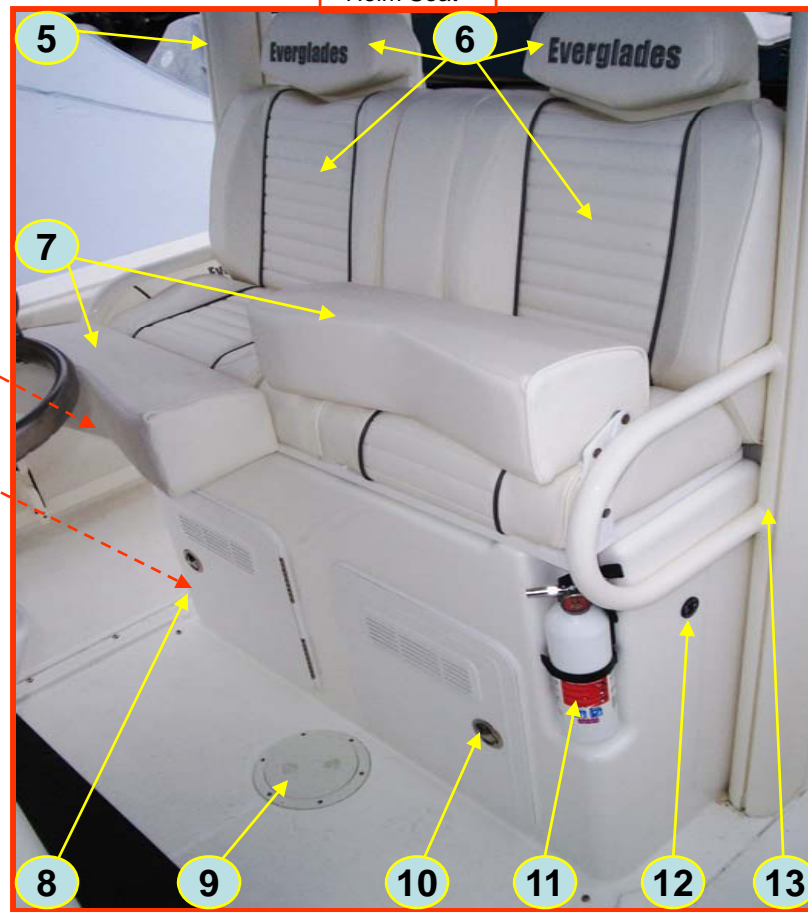

Helm Seat

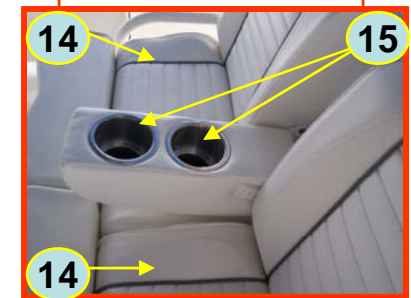

Fold Down Drink Holder

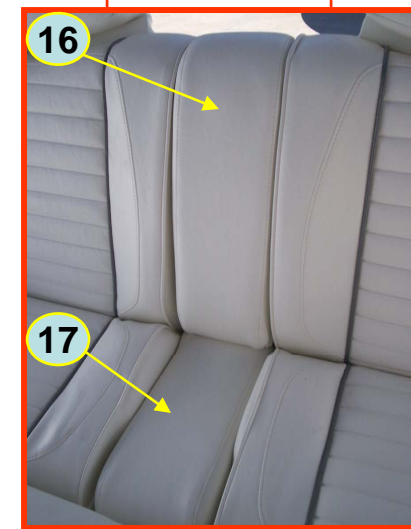

Center Cushions

- |  |  |
|--|--|
| 1. Alta:AH-RFB – 4qt. Washer Bottle W / Remote Fill            | 10. Innovative Product:MISC-1618LS – 16" x 18" Left Swing Door |
| 2. BCH:WASHER – Washer Label                                   | 11. Metalcraft:S-130-182 – Fire Extinguisher                   |
| 3. SeaTech:2423-10 – ½" Union Tee                              | 12. TH:MAV-2KT – Max Air Livewell Venturi                      |
| 4. Lewis:FIG252 – Shaft Zinc                                   | 13. RJAF:AFT-HTSUPPORT-P – Port Aft Hard Top Support           |
| 5. RJAF:AFT-HTSUPPORT-S – Stbd Aft Hard Top Support            | 14. Emerald Coast:2907108 – Pilot Helm Seat Bottom             |
| 6. Emerald Coast:2907111 – Pilot Helm Seat Back W / Headrest   | 15. RDI:1006RDI – Stainless Cup Holder                         |
| 7. Emerald Coast:2907110 – Pilot Helm Seat Flip Up             | 16. Emerald Coast:2907112 – Pilot Flip Down Drink Holder       |
| 8. Innovative Product:MISC-1618RS – 16" x 18" Right Swing Door | 17. Emerald Coast:2907109 – Pilot Helm Seat Bottom Center      |
| 9. Beckson:DP62-WP – 6" Twist Out Deck Plate                   | 18. Seadek:EBHP – Anti Fatigue Mat                             |

## 290Pilot Livewell Workstation

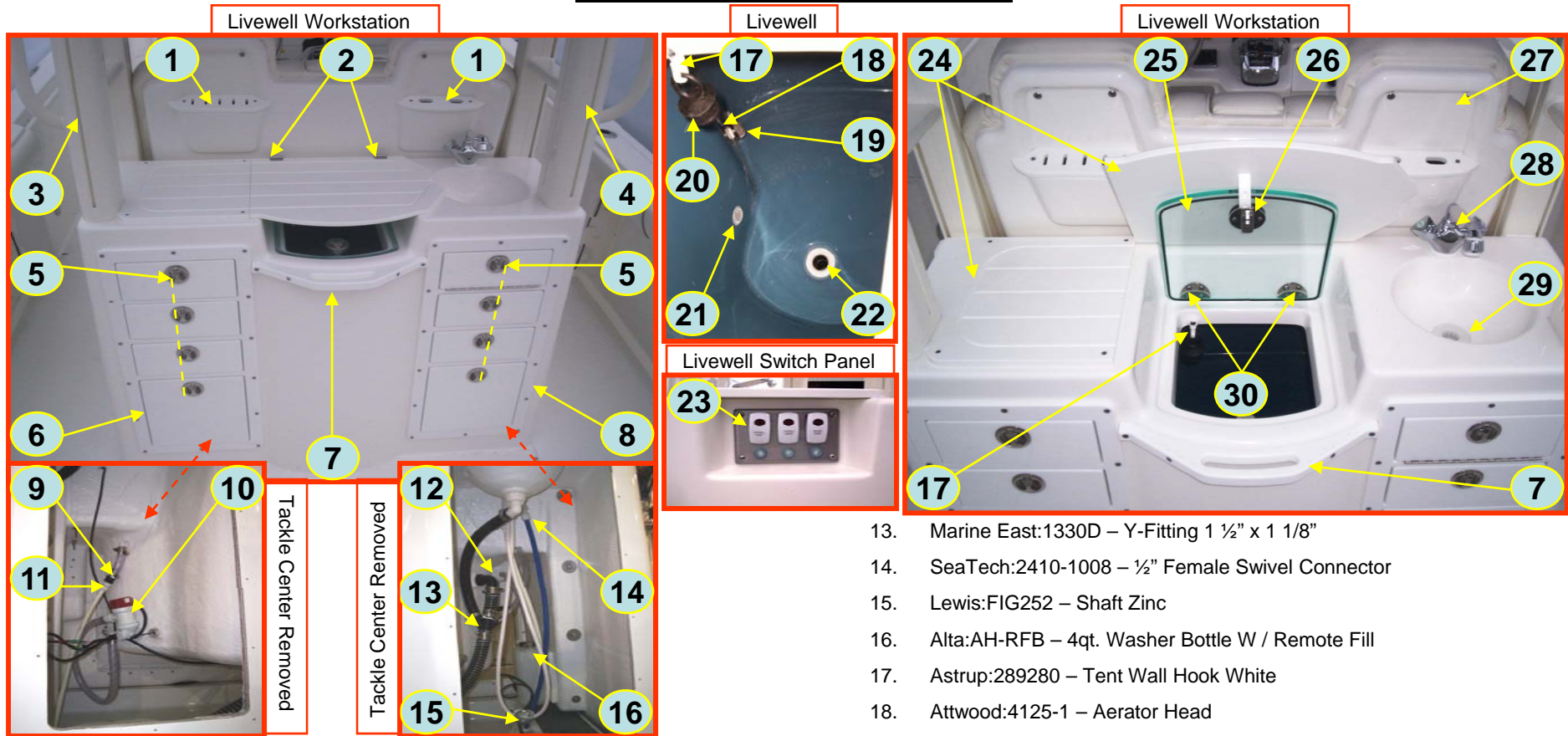

1. Spartech:280823 – Knife and Pliers Holder Set
2. GEM:1172 – Butt Hinge
3. RJAF:AFT-HTSUPPORT-P – Port Aft hard Top Support
4. RJAF:AFT-HTSUPPORT-S – Stbd Aft Hard Top Support
5. Orcas:9121455 – Bridge Pull Slam Latch Locking
6. Spartech:280803 – Port Tackle Center
7. Spartech:280809 – Leader Hand Rail
8. Spartech:280804 – Stbd Tackle Center
9. Marine East:8751 – ½" FPT x ¾" Hose Barb
10. Jabsco Rule:403CDM – 800 GPH Angle Pump
11. SeaTech:2410-1008 – ½" Female Connector
12. TH:1590-AFD – 1 ½" x 90 Degree Overflow

13. Marine East:1330D – Y-Fitting 1 ½" x 1 1/8"
14. SeaTech:2410-1008 – ½" Female Swivel Connector
15. Lewis:FIG252 – Shaft Zinc
16. Alta:AH-RFB – 4qt. Washer Bottle W / Remote Fill
17. Astrup:289280 – Tent Wall Hook White
18. Attwood:4125-1 – Aerator Head
19. TH:AS-1 – Screen / Strainer
20. TH:PP150 – Black Plug
21. Innovative Light:012-5500-1 – Star LED Livewell Light
22. Marine East:4143 – 1 ½" Angle T-Drain
23. BH:242-04453-P – Livewell Switch Panel
24. Spartech:280817 – Cutting Board
25. Spartech:280805 – Livewell Lid
26. Orcas:9121453 – Bridge Pull Slam Latch Non Locking
27. RJLM:PILOTSEATBACK – 290Pilot Helm Seat Back
28. Shurflo:135-0204-CW – Faucet
29. Marine East:6324W – 1 1/8" x 90 Degree Drain W / Basket
30. GEM:130200 – Round Two Hole Hinge

## 290Pilot Port Outboard Interior

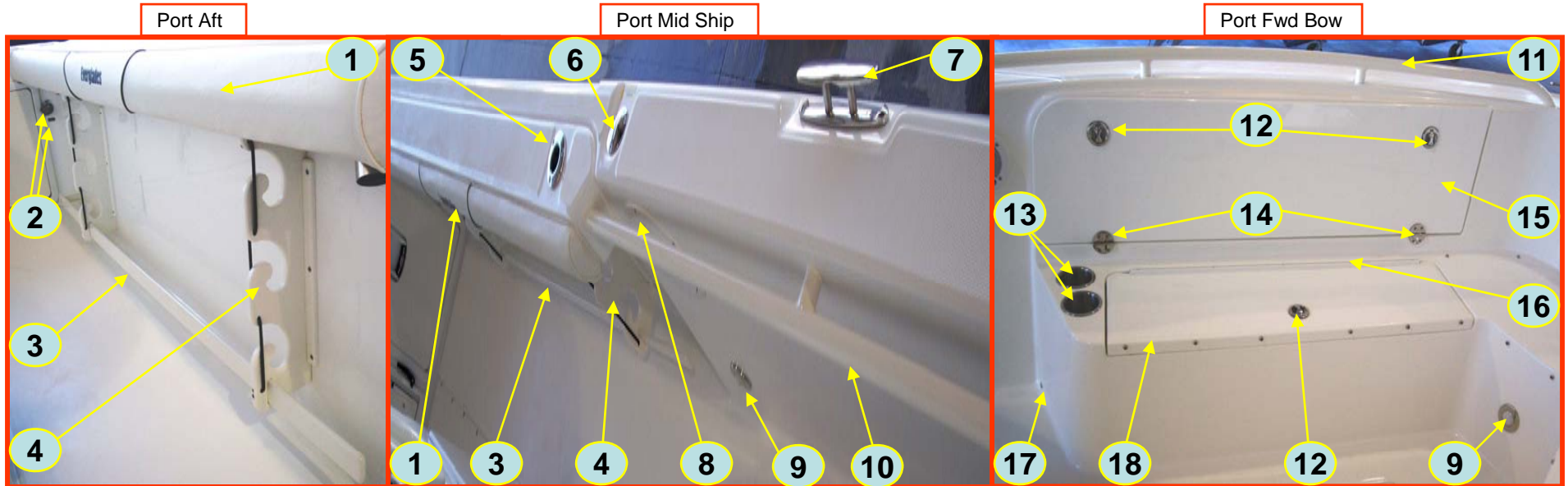

- |  |   |
|--|---|
| <ol style="list-style-type: none"> <li>1. Emerald Coast:2907106P – Coaming Pad Port</li> <li>2. Orcas:9004301 – Wash Down Faucet Stainless<br/>BCH:DS1 – Wash Down Label</li> <li>3. RJAF:290-TOERAIL-P – Toe Rail Port</li> <li>4. Teak Isle:290821 – Rod Rack Set</li> <li>5. GEM:105532 – 30 Degree Rod Holder</li> <li>6. GEM:99601 – 1 ½” Gas Deck Fill Plate</li> <li>7. GEM:68201 – 8” Pull Up Cleat</li> <li>8. DPI:DP-PULL8 – 8” Flush Pull Deck Plate White</li> <li>9. ITC:69650-SS – Red/White Combo LED Light</li> <li>10. RJAF:290-SIDERAIL-P – Port Mid Ship Side Rail</li> </ol> | <ol style="list-style-type: none"> <li>11. RJAF:290-BOWRAIL-P – Port Bow Rail</li> <li>12. Orcas:9121455 – Bridge Latch Locking</li> <li>13. RDI:1006RDI – Stainless Cup Holder</li> <li>14. GEM:130200 – Round Hinge Two Hole</li> <li>15. Spartech:280813 – Rod Locker Door</li> <li>16. Jefco:12239 – 38” x 2” Off Set Hinge</li> <li>17. Orcas:9503701 – 5/8” Impact Drain Stainless</li> <li>18. New Boston:PRL-29-4 – Port Rod Locker Door</li> </ol> |
|--|---|



## 290Pilot Starboard Outboard Interior

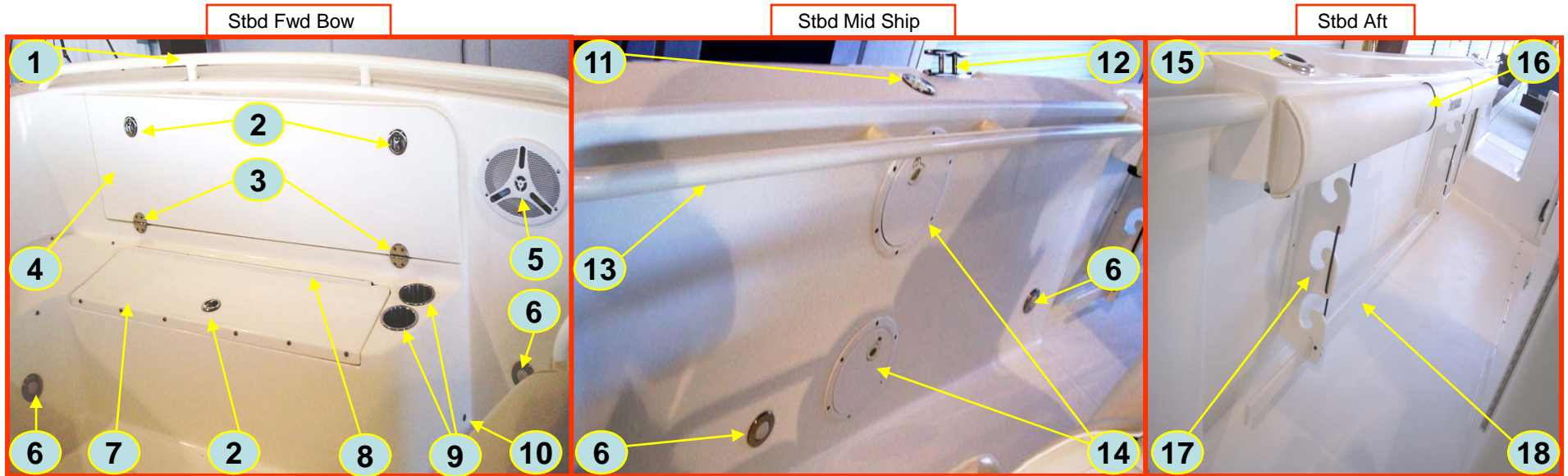

- |   |   |
|---|---|
| <ol style="list-style-type: none"> <li>1. RJAF:290-BOWRAIL-S – Stbd Bow Rail</li> <li>2. Orcas:9121455 – Bridge Latch Locking</li> <li>3. GEM:130200 – Round Hinge Two Hole</li> <li>4. Spartech:280813 – Rod Locker Door</li> <li>5. Marine Audio:CMCX7-1 – 7.7” marine Coaxial Speaker (Clarion) Opt.</li> <li>6. ITC:69650-SS –White / Red LED Light</li> <li>7. New Boston:STB-29-5 – Stbd Rod Locker Door\</li> <li>8. Jefco:12239 – 38” x 2” Off Set Hinge</li> <li>9. RDI:1006RDI – Stainless Cup Holder</li> <li>10. Orcas:9503701 – 5/8” Impact Drain Stainless</li> </ol> | <ol style="list-style-type: none"> <li>11. GEM:99901 – 1 ½” Waste Deck Fill</li> <li>12. GEM:68201 – 8” Pull Up Cleat</li> <li>13. RJAF:290-SIDERAIL-S – Stbd Mid Ship Side Rail</li> <li>14. DPI:DP-PULL8 – 8” Flush Pull Deck Plate White</li> <li>15. GEM:105532 – 30 Degree Rod Holder</li> <li>16. Emerald Coast:2907106S – Coaming Pad Stbd</li> <li>17. Teak Isle:290821 – Rod Rack Set</li> <li>18. RJAF:290-TOERAIL-S – Stbd Toe Rail</li> </ol> |
|---|---|

## 290Pilot Aft Cockpit Interior

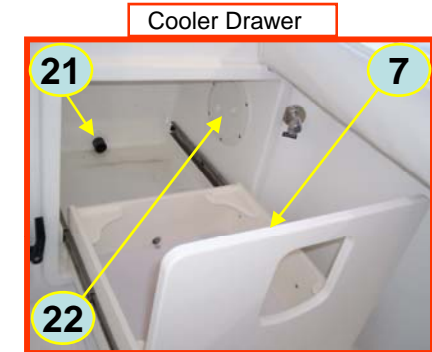
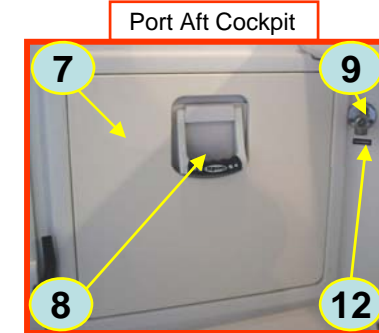
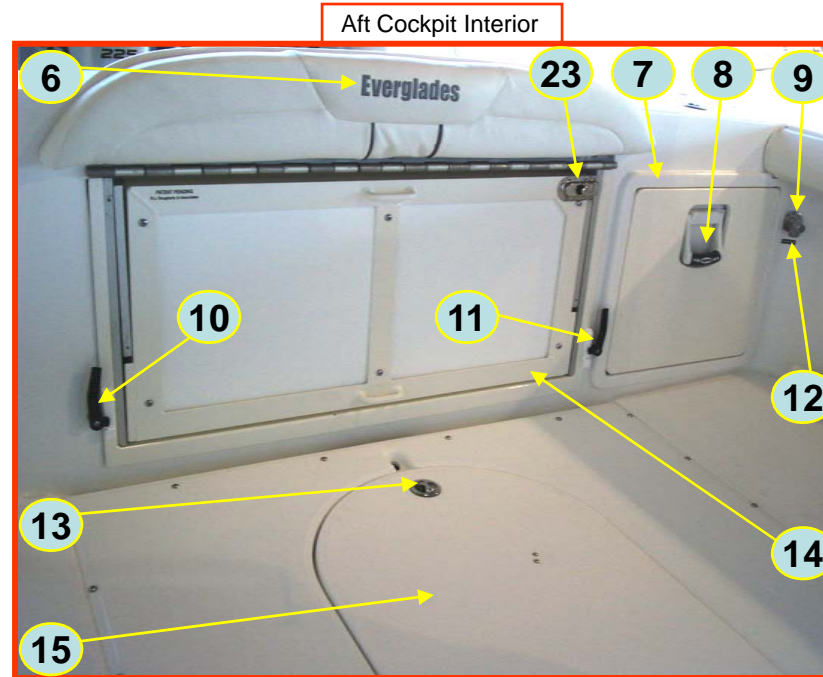
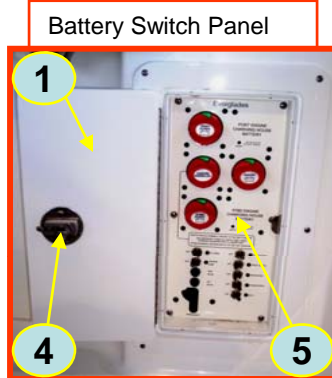
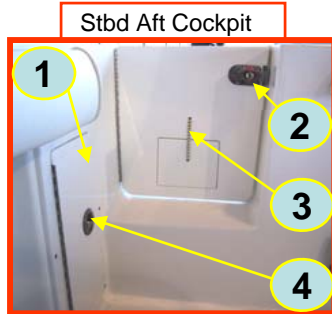

1. Spartech:280801 – Battery Switch Box
2. Orcas:9321251 – Magnetic Slide Latch  
Orcas:93212551 – Magnetic Latch (Hat Latch)
3. Teak Isle:290835 – Transom Door
4. Orcas:9121455 – Bridge Latch Locking
5. BH:245-04627-P – Battery Panel
6. Emerald Coast:2907102 – Stern Seat Back
7. Teak Isle:22-19565 – Cooler Drawer Assy
8. Hillman:0305170 – 50qt. Cooler  
Hillman:0305089 – Cooler Lid Only
9. Orcas:9004301 – Wash Down Faucet Stainless
10. Bomar:GP911-01 – Left Latch Dog Assy
11. Bomar:GP911-02 – Right Latch Dog Assy
12. BCH:DS1 – Wash Down Label

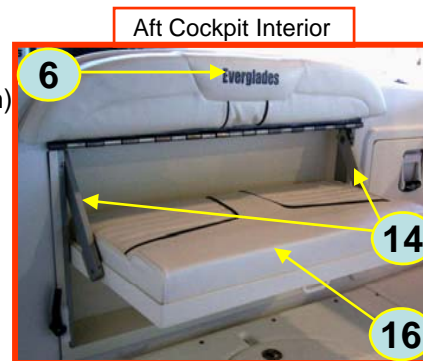

13. Orcas:9121453 – Bridge Latch Non Locking
14. RJAf:2629-STERNSEAT – Fold Down / Flip Up Stern Seat Assy.
15. New Boston:AFT-29-1 – Aft Fish Box Lid
16. Emerald Coast:2907101 – Stern Seat Bottom
17. TH:AS-1 – Screen / Strainer
18. Jefco:12190 – 19" x 2" Off Set Hinge
19. SPD:BRX1096SS – Two Hole SS Bracket
20. SPD:GSSX5300-60 – Gas Spring 60lb.
21. Industrial Hardware:1-776-2 – Eberhard Latch
22. Beckson:DP62-WP – 6" Twist Our Deck Plate
23. Orcas:9321255 – Magnetic Transom Latch

## 290Pilot Transom and Aft Bilge

Transom Interior

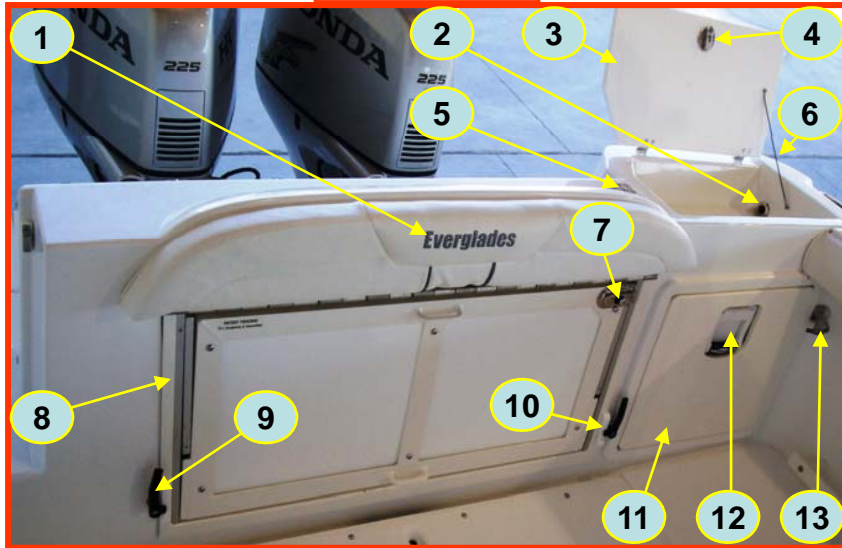

Transom Exterior

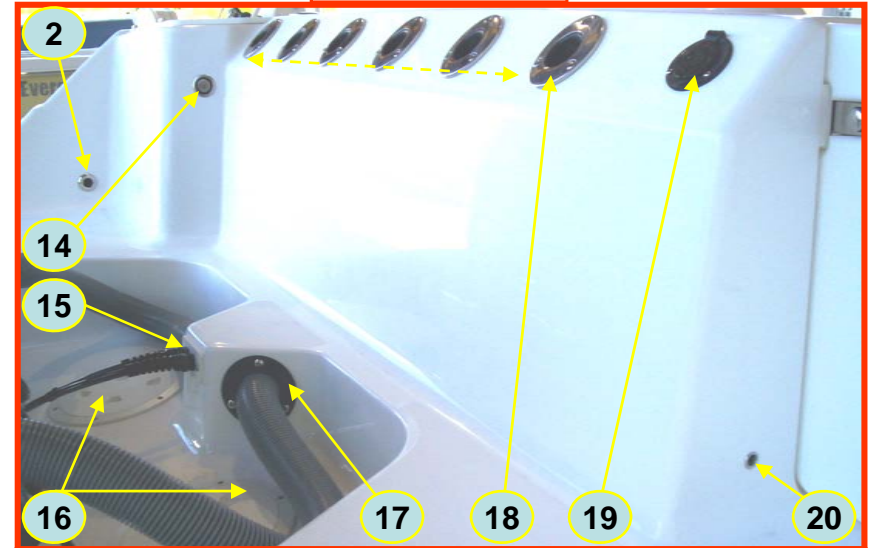

Aft Bilge

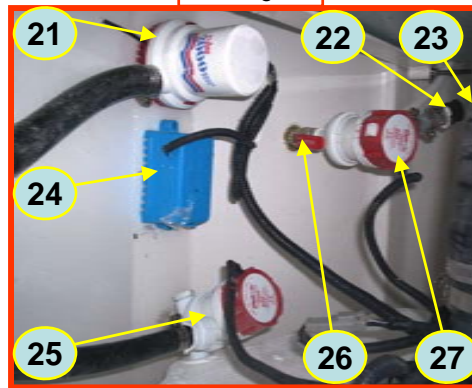

1. Emerald Coast:2907102 – Stern Seat Back  
Emerald Coast:2907101 – Stern Seat Bottom
2. Orcas:9005256 – ¾" x 90 Degree Thru Hull
3. Spartech:280833 – Rigging Bait Well Lid
4. Orcas:9121453 – Bridge Latch Non Locking
5. Orcas:8407016 – 1 ½" Water Fill Deck Plate
6. TH:DRS-1 – 13" Door Restraint
7. Orcas:9321255 – Magnetic Slide Latch
8. RJAF:2629-STERNSEAT – Fold Down / Flip Up Stern Seat Assy.
9. Bomar:GP911-01 – Left Latch Dog Assy
10. Bomar:GP911-02 – Right Latch Dog Assy
11. Teak Isle:22-19565 – Cooler Drawer Assy
12. Hillman:0305170 – 50qt. Cooler  
Hillman:0305089 – Cooler Lid Only
13. Orcas:9004301 – Wash Down Faucet Stainless  
BCH:DS1 – Wash Down Label

14. Orcas:8906223 – 90 Degree Vent Stainless
15. RJAF:HYDRAU-PLATE – Transom Hydraulic Steering Line Plate
16. Beckson:DP82-WP – 8" Twist Out Deck Plate
17. MPI:747-2000 – Rigging Grommet
18. GEM:105532 – 30 Degree Rod Holder
19. Marinco:150BBI.OEM – Bass Charging Inlet
20. Orcas:9503701 – 5/8" Impact Drain Stainless
21. Jabsco Rule:10DM – 2000 GPH Bilge Pump
22. Marine East:8751 – ½" FPT x ¾" Hose Barb
23. SeaTech:2401-1008 – ½" Male Connector
24. MPI:900-1000 – Sure Bail Float Switch
25. Jabsco Rule:403CDM – 800 GPH Angle Pump
26. Whitecap:P-5512 – ¾" Ball Valve
27. Jabsco Rule:403FCDM – 800 GPH Livewell Pump

## 290Pilot Aft Bilge Bulkhead

Aft Bilge Bulkhead

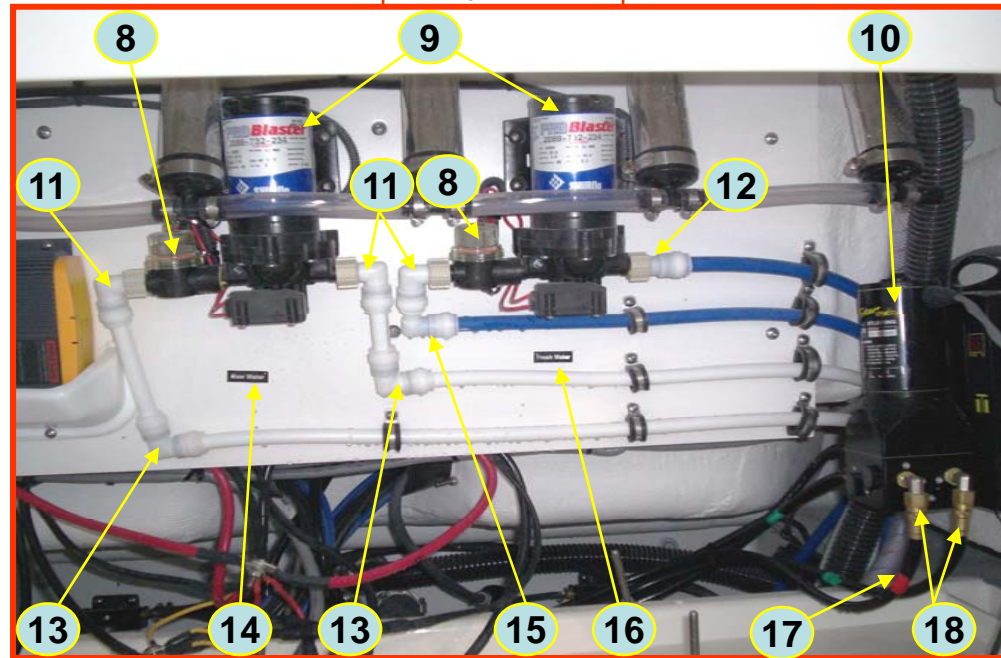
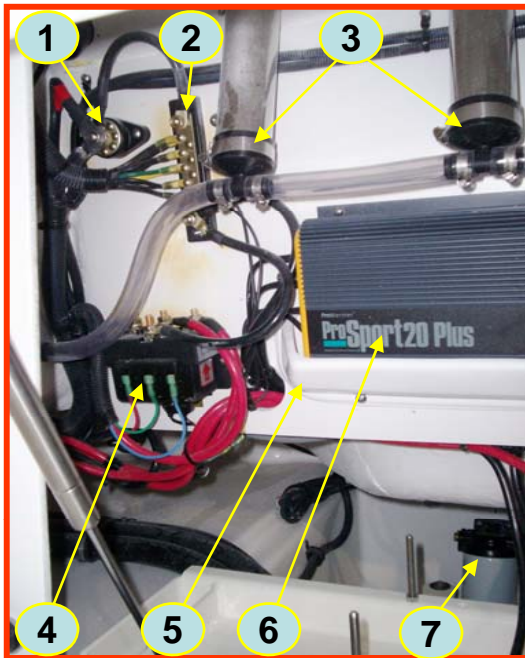

1. Blue Seas:2102B – Single 5/16" Buss W / 8 Ground Position
2. Bocatech:BTMH-15 – Buss Bar
3. Orcas:9122738-B – Drain Cup Double Barb
4. Anchorlift:SOL – Windlass Solenoid
5. SSI:70120000BULK – Port Hood White
6. Professional Mariner:41220 – Pro Sport Water Proof Charger
7. Sierra:118-7852-1 – Fuel Water Separator With Filter

8. Shurflo:255-213 – Strainer Male / Female
9. Shurflo:2088-732-234 – 3.4 Pro Blaster Pump
10. Teleflex:PA12 – Power Assist Steering Pump
11. SeaTech:2420-1008 – ½" Female Swivel Elbow
12. SeaTech:2410-1008 – ½" Female Swivel Connector
13. SeaTech:2417-10 – ½" Union Elbow
14. BCH:RAW: Raw Water Label
15. SeaTech:2418-10 – ½" Stackable Elbow
16. BCH:FRESH WATER – Fresh Water Label
17. Parker:873621 – Hydraulic Steering Hose
18. Parker:ITFMS-6-5B – Brass Hose Fitting Crimp
19. SPD:BS1005SS – Stainless Ball End
20. Ameritool:750-10S-55 – Gas Spring 55lb. Stainless
21. Best Fab:SW18 – Fuel Sender 18"

## 290CC Hull Exterior

Stbd Aft



Stbd Mid Ship

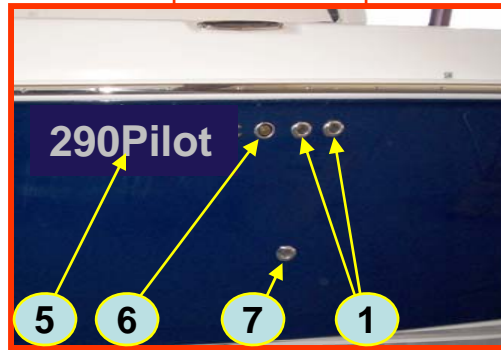

Stbd Bow

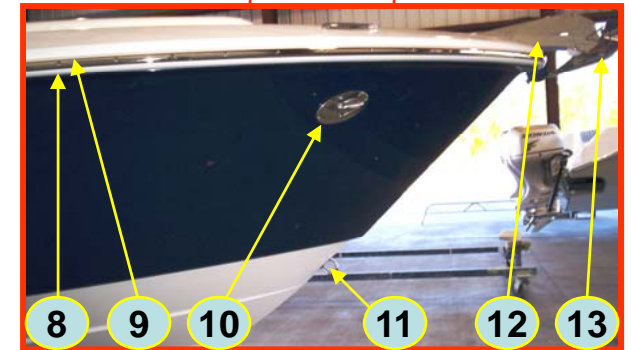

Port Bow

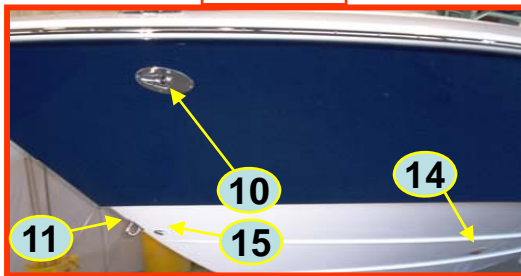

Port Mid Ship

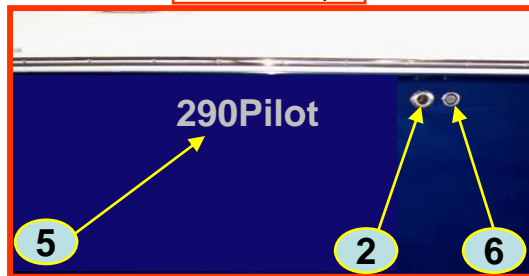

Transom

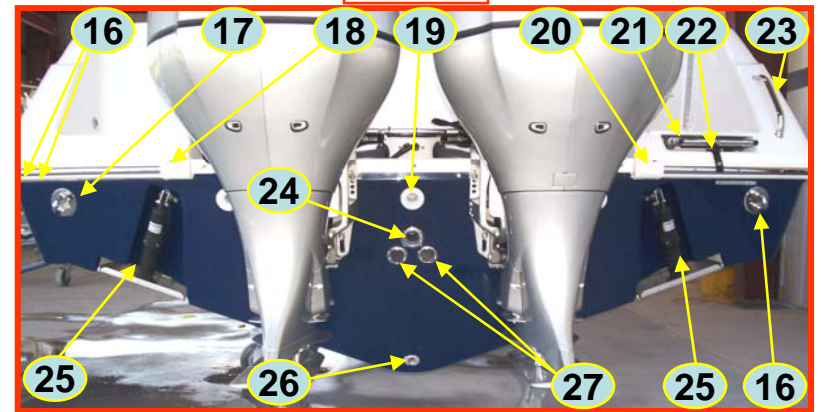

1. Orcas:9005256 – ¾" x 90 Degree Thru Hull
2. Orcas:9005257 – 1 1/8" x 90 Degree Thru Hull
3. BCH:DS3 – Ram Cap Label
4. Douglas:EGL – Everglades Chrome Logo
5. Douglas:290CC – 290cc Chrome Logo  
Douglas:PILOT – Pilot Logo
6. GEM:954 – 5/8" x 90 Degree Vent
7. Orcas:9105419 – 1" x 90 Degree Thru Hull
8. Taco:V21-9502WHC20D – Rub Rail White 20'
9. Taco:S11-4650P16B – Stainless Insert
10. Innovative Light:580-0200-1 – Docking light
11. Orcas:9026316 – 5/8" x 5 ½" Bow Eye
12. Challenger:BR260290 – Bow Roller Stainless
13. Anchorlift:RSA-8 – Stainless Anchor (Opt)  
Anchorlift:SA-8 – Galvanized Anchor 17.5lb.
14. Seadog:367583 – ¾" Intake Strainer
15. GFM:R39 – Clam Shell Stainless

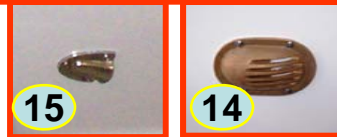

16. Taco:M16-4650-3-PORT – Port Molded Rub Rail W / Insert  
Taco:M16-4650-3-STBD – Stbd Molded Rub Rail W / Insert
17. Orcas:9107727 – 5/8" x 5" Stern Eye
18. RJAF:ENDCAP-P – Gunnel Mold End Cap Port
19. GEM:73101 – 1 1/2" Motor Well Thru Hull
20. RJAF:ENDCAP-S – Gunnel Mold End Cap Stbd
21. Teak Isle:22-19668 – Swim Ladder Cover
22. Windline:TPL-3XQA – 3 Step Transom Ladder
23. Orcas:09024271 – 12" x 1" Grab Rail
24. Orcas:9005261 – 1 ½" x 15 Degree Thru Hull
25. Linear:VKAS12X12-8119 – 12" x 12" Trim Tab
26. Orcas:9004266 – Garboard Drain Oval
27. Orcas:9105516 – 2" Thru Hull Scupper